



STATISTICAL ANALYSIS OF HEAVY TRUCK LOADS USING WISCONSIN WEIGH-IN-MOTION DATA

Project 01-02
September 2009

National Center for Freight & Infrastructure Research & Education
College of Engineering
Department of Civil and Environmental Engineering
University of Wisconsin, Madison



Authors: Habib Tabatabai, Jian Zhao, and Chin-Wei Lee
University of Wisconsin-Milwaukee

Principal Investigator: Habib Tabatabai
Associate Professor, Department of Civil Engineering & Mechanics
University of Wisconsin-Milwaukee

Technical Report Documentation Page

1. Report No. CFIRE 01-02	2. Government Accession No.	3. Recipient's Catalog No. CFDA 20.701	
4. Title and Subtitle Statistical Analysis of Heavy Truck Loads Using Wisconsin Weigh-In-Motion Data		5. Report Date September 2009	
		6. Performing Organization Code	
7. Author/s Habib Tabatabai, Jian Zhao, and Chin-Wei Lee		8. Performing Organization Report No.	
9. Performing Organization Name and Address Department of Civil Engineering & Mechanics University of Wisconsin-Milwaukee 3200 N. Cramer Street Milwaukee, WI 53211		10. Work Unit No. (TRAIS)	
		11. Contract or Grant No. DTRT06-G-0020	
12. Sponsoring Organization Name and Address Research and Innovative Technology Administration United States Department of Transportation 1200 New Jersey Avenue, SE Washington, DC 20590		13. Type of Report and Period Covered Final Report [06/01/08 – 06/30/09]	
		14. Sponsoring Agency Code	
15. Supplementary Notes Project completed for CFIRE with support from the Wisconsin Department of Transportation.			
16. Abstract This study involved statistical evaluation of heavy truck loads that were recorded in 2007 using Weigh-In-Motion stations located throughout the State of Wisconsin. The heaviest 5% of all trucks in each class and axle groupings were selected for further analyses. Best fit unimodal and multimodal distributions for all axle loads and spacings in each truck class were determined. Multivariate Monte Carlo simulations using the marginal distributions and empirical copulas were performed to assess maximum moments and shears in simply supported bridges. Moments and shears due to the 250-kip Wisconsin Permit Vehicle were compared with simulation results. The multivariate Monte Carlo simulations of truck loadings can be used to assess the reliability of bridges and pavements as well as detailed fatigue analyses.			
17. Key Words Weigh-in-motion, truck loads, statistical analysis, copulas, WIM, bridge loads, Monte Carlo simulations	18. Distribution Statement No restrictions. This report is available through the Transportation Research Information Services of the National Transportation Library.		
19. Security Classification (of this report) Unclassified	20. Security Classification (of this page) Unclassified	21. No. Of Pages 193	22. Price -0-

DISCLAIMER

This research was funded by the National Center for Freight and Infrastructure Research and Education. The contents of this report reflect the views of the authors, who are responsible for the facts and the accuracy of the information presented herein. This document is disseminated under the sponsorship of the Department of Transportation, University Transportation Centers Program, in the interest of information exchange. The U.S. Government assumes no liability for the contents or use thereof. The contents do not necessarily reflect the official views of the National Center for Freight and Infrastructure Research and Education, the University of Wisconsin, the Wisconsin Department of Transportation, or the USDOT's RITA at the time of publication.

The United States Government assumes no liability for its contents or use thereof. This report does not constitute a standard, specification, or regulation.

The United States Government does not endorse products or manufacturers. Trade and manufacturers names appear in this report only because they are considered essential to the object of the document.

EXECUTIVE SUMMARY

This study involved statistical evaluation of heavy truck loads that were recorded using Weigh-In-Motion stations located throughout the State of Wisconsin. All records (just under 6 million vehicles) were collected within a one-year period (2007). FHWA trucks Classes 5 through 15 were retained. Vehicle classes 4 (buses) or less represent smaller vehicles and buses, and were thus excluded from analyses.

If a truck class contained multiple numbers of axles, then that class was further sub-divided such that each sub-group would contain only one particular number of axles. For example, Classes 08-03 and 08-04 contained class 08 vehicles with 3- and 4-axles, respectively. Data in each class-axle groupings were sorted based on gross vehicle weight, and the heaviest 5 percent (H5P) of truck records in each group were separated and analyzed. Statistical analyses were performed on the H5P data.

Using the H5P data, best-fit unimodal and/or multimodal distributions (“marginal” distributions) were determined for each axle weight and spacing in each truck class-axle group. Furthermore, copulas were determined to allow multivariate Monte Carlo simulations. Copulas help perform multivariate simulations while maintaining interdependence between various marginal distributions.

Selected Multivariate Analysis of Variance (ANOVA) was performed on a few class-axle groupings based on different WIM station results. ANOVA indicated that the various WIM stations records did not belong to the same distributions. Therefore, data from all stations were combined in various class-axle groupings.

Multivariate Monte Carlo simulations on H5P data in each class-axle group were conducted using Crystal Ball and ModelRisk software programs within Microsoft Excel. A spreadsheet program was written to calculate maximum moments and shears in a simply supported beam with spans ranging from 20 ft to 250 ft. Each simulated vehicle was “marched” across the bridge to find maximum effects. Each simulation analysis consisted of 10,000 runs (i.e. 10,000 trucks automatically generated from marginal distributions and copulas). The maximum moments and shear for each of the spans and each of the 10,000 runs were calculated, and the different percentile values for the simulation results were determined. Maximum moments and shears associated with the 250-kip Wisconsin Permit Vehicle (WPV) were also calculated for each span length, and compared with simulation results.

The following observations are made:

- 1) Truck simulations for each class-axle grouping were performed and successfully tested for validity.
- 2) Some H5P axle loads and axle spacing distributions are multimodal, and multimodal marginal distributions must be used in such cases for proper simulations.

- 3) Empirical copulas provide more accurate simulations when compared to conventional copula functions determined by data fitting. All simulation results reported here are based on empirical copulas determined using the ModelRisk software.
- 4) The percentile results derived can be used to assess the relative impact of any truck arrangement compared to simulation results. Moments and shears due to the Wisconsin Permit Vehicle were, in all cases, above the 96 percentile mark for the H5P simulation data. This is approximately equivalent to the 99.8 percentile for all trucks in each class.
- 5) It is clear that the Wisconsin Permit Vehicle results completely envelope most of the longer span length results (at 100 percentile). However, at shorter spans and for some truck classes, the percentile mark is reduced. This indicates that the probability of exceeding the permit vehicle effects is not uniform across all span lengths in simply supported bridges.
- 6) The marginal distributions and copulas determined here can also be used to statistically assess heavy truck impact on bridges and pavements based any load-dependent metric.

The following recommendations are made for future studies:

- 1) Expand determination of marginal distributions and copulas to the entire dataset of trucks (not just H5P data).
- 2) With data from the item 1 above, detailed fatigue studies can be performed in much greater detail and precision that would otherwise not be feasible without such information.
- 3) Conduct statistical analyses using the existing H5P information developed in this study as well as data from recommendation No. 1 to enhance understanding of degree of reliability and performance in Portland cement concrete and asphalt pavements.

Contents

STATISTICAL ANALYSIS OF HEAVY TRUCK LOADS USING WISCONSIN WEIGH-IN-MOTION DATA	1
DISCLAIMER	2
EXECUTIVE SUMMARY	3
INTRODUCTION	7
RESEARCH OBJECTIVES	7
RESEARCH SCOPE	7
VEHICLE CLASSIFICATIONS.....	8
WEIGH-IN-MOTION	9
STATISTICAL DISTRIBUTIONS FOR H5P DATA	15
COPULAS	19
MONTE CARLO SIMULATIONS.....	21
SUMMARY AND CONCLUSIONS	33
REFERENCES	35
APPENDICES	37
APPENDIX A – SINGLE MODE DISTRIBUTIONS FIT TO H5P DATA	37
APPENDIX B – MULTI-MODAL DISTRIBUTIONS FIT TO H5P DATA.....	51
APPENDIX C – COPULA RESULTS.....	60
APPENDIX D – SIMULATION RESULTS.....	64
APPENDIX E – SIMULATION RESULTS & ACTUAL DATA.....	147
APPENDIX F - DESCRIPTIVE ANALYSIS OF WISCONSIN WIM DATA ⁽⁹⁾	162

Page Left Blank Intentionally

INTRODUCTION

There are 17 Weigh-In-Motion (WIM) stations in Wisconsin that record truck weight information as vehicles pass over their sensors at normal speeds. The WIM data include all legal and illegal trucks that may cross the WIM sensors, and thus provide a reasonably complete picture of truck loads. Understanding the statistical variability of different classes of truck loads is considered important with respect to probabilistic evaluation of overweight truck impacts on bridges and pavements. This study is designed to collect and analyze WIM truck data from all stations in Wisconsin for the entire year of 2007. Approximately 6 million truck records (truck classes 5 through 15) were evaluated in this study. Statistical analyses were performed on the heaviest 5 percent of trucks in each class.

RESEARCH OBJECTIVES

The objectives of this research were as follows:

- Analyze Wisconsin WIM data to obtain axle weight and spacing information for heavy trucks in various truck classes. This will provide detailed information on load characteristics of heavy trucks traveling on Wisconsin highways.
- Determine unimodal and multimodal statistical distributions for all axle loads and spacings for the heaviest 5% of all trucks in each truck class, and determine multivariate “copulas” that map relationships between different distributions.
- Conduct multivariate Monte-Carlo simulation studies based on the statistical distributions and copulas.

RESEARCH SCOPE

W-card data from Wisconsin WIM stations were obtained. They were exported into Microsoft Excel spreadsheets for analyses. Excel truck data were checked to ensure that all sets of data were valid. Data were then sorted based on truck class. Only records for truck classes 5 through 15 were retained. For each truck class, two sets of data were developed; A complete set as well as a partial set containing the heaviest 5 percent (H5P) of all trucks in that class. The H5P data are significant with respect to impact of heavy loads on bridges and pavements. By separating and analyzing the H5P data, the accuracy of predictions on heavy loads would be improved significantly. For example, fitting a statistical distribution to the H5P data would be more accurate than looking at the tail of a distribution fit to the entire dataset.

Srinivas, Menon, and Prasad⁽¹⁾ describe an approach for determining multivariate statistical distributions of truck axle weights and spacing using copulas. This approach was used to determine relevant distributions in this study. It is believed that considering axle weight and axle spacing as independent variables would not be as accurate since the interdependencies of various axle loads and spacings would not be considered. Also, conducting multivariate analyses using linear correlation coefficients would not describe the dependence accurately for non-elliptical distributions^{(1), (4)}. Therefore, multivariate analyses and simulations using copulas were used in this study.

The software used in the data analyses phase of this study included Crystal Ball⁽²⁾, which is a forecasting and Monte Carlo simulation program that runs within the MS Excel platform, and ModelRisk⁽³⁾, which is a quantitative risk analysis program that also runs within MS Excel. Both Crystal Ball and ModelRisk can fit statistical distributions to a given dataset. ModelRisk can also fit copulas or determine empirical copulas based on data. Crystal Ball and ModelRisk can be run together to perform Monte Carlo simulations involving the determined distributions and copulas.

VEHICLE CLASSIFICATIONS

The Federal Highway Administration (FHWA) has established the following truck classifications as defined by the Traffic Monitoring Guide (TMG) published in 2001.⁽⁵⁾ TMG identifies 13 different vehicle classes. Partial descriptions are shown in Table 1. In addition to the thirteen FHWA vehicle classes, the Weigh-In-Motion (WIM) data also include classes 14 and 15. Class 14 includes truck-trailer combinations and class 15 is allocated to unclassified and/or system errors. Lu et al.⁽⁶⁾ present the classification information in graphical form as shown in Figure 1.























WIM TRUCK CLASSIFICATION PARAMETERS							
4		5		6		7	
	2S		2D		3A		4A
	2D						
	3A						
8		9		10		11	
	2S1		3S2		3S3		2S+2
	2S2		LOG				
	31		32 PUP				
	3S1						
12		13		14		15	
	3S12		2S23		32	UNCLASSIFIED AND/OR SYSTEM ERRORS	
			3S13		32		
			3S22				
			PERMIT				
		ALL OTHER 7+ AXLE					

Figure 1. Truck classifications⁽⁶⁾

Table 1. FHWA Vehicle Classes⁽⁵⁾

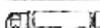
Class	Vehicle Type	Description
1	Motorcycles	All two or three-wheeled motorized vehicles.
2	Passenger Cars	All sedans, coupes, and station wagons manufactured primarily for the purpose of carrying passengers and including those passenger cars pulling recreational or other light trailers
3	Other Two-Axle, Four-Tire Single Unit Vehicles	All two-axle, four-tire, vehicles, other than passenger cars. Included in this classification are pickups, panels, vans, and other vehicles such as campers, motor homes, ambulances, hearses, carryalls, and minibuses.
4	Buses	All vehicles manufactured as traditional passenger-carrying buses with two axles and six tires or three or more axles.
5	Two-Axle, Six-Tire, Single-Unit Trucks	All vehicles on a single frame including trucks, camping and recreational vehicles, motor homes, etc., with two axles and dual rear wheels.
6	Three-Axle Single-Unit Trucks	All vehicles on a single frame including trucks, camping and recreational vehicles, motor homes, etc., with three axles.
7	Four or More Axle Single-Unit Trucks	All trucks on a single frame with four or more axles.
8	Four or Fewer Axle Single-Trailer Trucks	All vehicles with four or fewer axles consisting of two units, one of which is a tractor or straight truck power unit.
9	Five-Axle Single-Trailer Trucks	All five-axle vehicles consisting of two units, one of which is a tractor or straight truck power unit.
10	Six or More Axle Single-Trailer Trucks	All vehicles with six or more axles consisting of two units, one of which is a tractor or straight truck power unit.
11	Five or fewer Axle Multi-Trailer Trucks	All vehicles with five or fewer axles consisting of three or more units, one of which is a tractor or straight truck power unit.
12	Six-Axle Multi-Trailer Trucks	All six-axle vehicles consisting of three or more units, one of which is a tractor or straight truck power unit.
13	Seven or More Axle Multi-Trailer Trucks	All vehicles with seven or more axles consisting of three or more units, one of which is a tractor or straight truck power unit.

WEIGH-IN-MOTION

Weigh-in-Motion (WIM) records from the Wisconsin Transportation Center are analyzed in this study. WIM devices are designed to capture and record truck axle weights, axle spacing, and gross vehicle weights.

The information recorded by WIM stations is coded into W-cards or E-cards and submitted to the Federal Highway Administration (FHWA). W-cards are in metric units while the E-cards are in English units. A sample record from a W-card data is discussed below. Also, information on all WIM stations in Wisconsin is shown in Table 2.

W-Card data line corresponding to one truck: **W55250529310602010005....009502032040064**

Table 1. Descriptions of W-Card Information

Data	Description
55	FIPS state code - state of Wisconsin
250529	Station identification number (see below for the available stations in Wisconsin)
3	Direction of travel
1	Lane of travel
06020100	Travel date and time, in yy-mm-dd-hr
05	Vehicle class
0095	Total weight of vehicle to the nearest tenth of a metric ton (100 kilograms)
02	Total number of axles
032	The front axle weight (axle A) to the nearest tenth of a metric ton (100 kilograms)
040	Axle spacing A-B (Between axles A and B) to the nearest tenth of a meter (100 mm)
032040	The axle weight and spacing pairs repeated for (for all remaining axles)
064	The axle weight of the last axle to the nearest tenth of a metric ton (100 kilograms)

Table 2. WIM Stations in Wisconsin

Station	Location
030010	USH 53, Cameron
040002	USH 2, Ino
100001	STH 29, Thorp
220001	USH 61/1 51, Dickeyville
250529	USH 18,151, Dodgeville
260001	USH 151, Mercer
360002	II I 43, Cooperstown
370006	STH 29, Hatley
390105	IH39, bndeavoi
410240	IH94, Toma
410253	IH 90, Sparta
450239	IH43, Port Washington
470102	STH 29 River Falls
530001	IH 39/90, Newville
576051	USH63,Hayward
590608	STH 23, Kohler
640348	IH 43 Delevan

All data produced by Wisconsin WIM stations in 2007 were obtained from the Wisconsin Department of Transportation (WisDOT). A total of nearly 6 million vehicle WIM records were obtained. A few stations did not record any data in 2007, while others were operating part of the year only. Table 3 shows the number of vehicle records (classes 2 through 15) obtained from all stations in 2007. There were some records with the station identified as “0”. Those records were included in the analyses.

For data analyses, vehicle classes 5 through 15 (i.e. trucks) were considered only (i.e. non-truck classes 2,3, and 4 were removed). Truck data were first tested to make sure that they were valid, and invalid truck records were discarded (approximately 0.1% of all truck data). Three validity tests were performed for each data line (truck record):

1. Is the total weight reported on the W-card for each truck within 5% of the sum of all axle weights reported?
2. Does the number of axles reported on the card match the number of axle weights reported?
3. Are all axle spacings reported reasonable? Records that showed axle spacing of less than 20 inches were discarded.

Data that failed these tests were not included in further analyses. Of the total of 5,761,802 unfiltered records for classes 5 through 15, only 4,352 records (or 0.08%) were discarded based on the above three criteria. Table 4 shows the number of unfiltered truck records as grouped within different classes for different months of 2007.

Some truck classes may have different number of axles. For example, class 7 trucks could have either 4 or 5 axles (designated as classes 07-04 and 7-05) while class 8 trucks could have 3 or 4 axles (classes 08-03 and 08-04). Table 5 breaks down the number of trucks based on class and number of axles. WIM data for class 13 and 15 trucks include a large number of axle variations within the same class.

Data associated with the same number of axles within each class had to be separated before calculating the best fit statistical distributions. For example, two sets of statistical distributions were determined for class 7.

Table 5 also shows the number of filtered trucks in each class (and axle) category as a percentage of trucks in each class as well as percentage of all filtered trucks. Class 9 trucks make up over 61.7% of all WIM trucks. There were over 3.5 million class 9 vehicles in the 2007 data. The second and third most common trucks are classes 8 and 5 at 14.7% and 13.0%, respectively.

The minimum, maximum, and 95 percentile values for the total weight of each truck class are also shown in Table 5. For example, the maximum recorded total weight for a class 9 was 242.5 kips and the 95 percentile weight was 104.9 kips.

It is extremely important that the heaviest trucks in each class are accurately represented in the analyses and simulations. Therefore, the heaviest 5 percent (H5P) of trucks in each class-axle category (i.e. trucks that weigh more than the 95th percentile value) were separated and analyzed. This is considered preferable (more accurate) relative to fitting distributions to the entire data and estimating the worst effects from the distribution tails. Basic H5P information for each class-axle category is shown in Table 5.

A different approach involving selection of “representative” vehicles corresponding to heavy trucks in each class (based on the 2007 Wisconsin WIM data) was utilized by Zhao and Tabatabai in a companion study to the one reported here.⁽⁹⁾ The effects of these “representative” vehicles on simple-span, two-span continuous, and 3-span continuous bridges were studied by Zhao and Tabatabai.⁽⁹⁾ A chapter of that report describing the representative vehicles and analysis results is reproduced completely in Appendix F of this report for reference.

Table 3. Raw Vehicle Records from all WIM Stations in All Months of 2007

Stations	Jan.	Feb.	Mar.	Apr.	May	June	July	Aug.	Sept.	Oct.	Nov.	Dec.	TOTAL
0	21456	19122	22183	17186	31204	32899	35081	35617	30815	30399	21611	14416	311989
30010	12807	0	0	0	60055	66559	20478	22227	54777	32949	41365	35311	346528
40002	0	0	0	0	0	0	6050	29519	22726	24098	18394	13667	114454
100001	89409	39056	57911	27132	42302	17412	2041	17082	16896	24379	15069	0	348689
220001	27203	26492	35286	38605	70501	63663	67780	73481	61924	74553	61278	46063	646829
250529	88486	74797	83352	48932	51497	71679	35772	0	0	0	0	0	454515
260001	0	0	0	0	0	0	0	0	0	0	0	0	0
360002	8054	6208	0	249	34997	0	0	0	0	24775	80140	77903	232326
370006	0	0	0	0	0	0	0	0	0	0	0	0	0
390105	61578	24319	8345	7591	35253	0	0	0	0	0	0	0	137086
410240	0	0	0	0	228030	215906	200444	222604	198999	234690	199252	177924	1677849
410253	0	0	0	0	129640	126113	138187	148541	117502	136091	111740	97566	1005380
450239	0	0	0	0	0	0	0	0	0	0	0	0	0
470102	6087	4968	6073	3298	2641	0	6230	9115	7421	8761	6687	5047	66328
530001	0	0	0	0	0	0	0	0	0	0	0	0	0
576051	7291	6772	5655	0	13174	13650	16876	15345	11252	11087	8102	6807	116011
590608	38395	27317	35086	41011	49887	47827	54562	57059	44703	53391	41148	33859	524245
640348	0	0	0	0	0	0	0	0	0	0	0	0	0
Total	360766	229051	253891	184004	749181	655708	583501	630590	567015	655173	604786	508563	5982229

Table 4. Number of Unfiltered Truck Records in Each Vehicle Class in 2007

Classification	Jan	Feb	Mar	Apr	May	Jun	Jul	Aug	Sep	Oct	Nov	Dec	Total
Class 05	61472	42417	44533	31252	87485	77963	70912	72290	64979	70679	68312	57115	749409
Class 06	15133	9470	12368	11901	31637	25314	23411	27597	26198	27075	24445	17365	251914
Class 07	1656	1257	3156	3041	9796	6952	8239	9915	7818	10315	7760	3267	73172
Class 08	25836	17226	22899	18617	124162	121046	117640	122218	101025	79634	60791	37978	849072
Class 09	204243	117930	124366	90877	442906	364234	323198	369110	336788	418136	403424	359488	3554700
Class 10	5547	3778	4560	3024	9676	7498	6044	7877	6346	8574	8491	6349	77764
Class 11	3362	1625	1432	955	12768	10631	9091	11039	9798	12271	11348	10258	94578
Class 12	687	408	307	185	3977	3402	3004	3570	3164	4165	4016	3692	30577
Class 13	971	909	1399	734	1713	1533	1076	510	506	626	570	360	10907
Class 14	72	66	396	254	111	148	84						1131
Class 15	9730	8708	13921	7183	8430	10611	7167	512	601	721	649	345	68578
Total	328709	203794	229337	168023	732661	629332	569866	624638	557223	632196	589806	496217	5761802

Table 5. Detailed Information on Different Truck Classes

Class	Class - Axles	Un-filtered	Filtered Truck Data						H5P		
			Count	% of Total	% of Class	Min Wt. (Kips)	Max Wt. (Kips)	95th %ile	Count	Min Wt. (Kips)	Max Wt. (Kips)
Class 5	05-02	749409	748658	13.00%	100.00%	0.22	78.48	24.69	38565	24.69	78.48
Class 6	06-03	251914	251795	4.37%	100.00%	0.66	119.93	53.35	12730	53.35	119.93
Class 7	Total	73172	73138	1.27%		1.10	187.17	89.51	3674	89.51	187.17
	07-04		25753	0.45%	35.21%	1.10	187.17	79.81	1313	79.81	187.17
	07-05		47385	0.82%	64.79%	1.32	171.96	93.26	2386	93.26	171.96
Class 8	Total	849072	848482	14.74%		0.66	153.00	46.30	42763	46.30	153.00
	08-03		634745	11.02%	74.81%	0.66	145.28	26.01	32061	26.01	145.28
	08-04		213738	3.71%	25.19%	0.88	153.00	68.34	10836	68.34	153.00
Class 9	09-05	3554700	3553613	61.72%	100.00%	1.10	242.51	104.94	177857	104.94	242.51
Class 10	Total	77764	77185	1.34%		1.32	267.20	116.62	3883	116.62	267.20
	10-06		72939	1.27%	94.50%	1.32	267.20	114.64	3662	114.64	267.20
	10-07		4246	0.07%	5.50%	1.76	235.67	143.52	215	143.52	235.67
Class 11	11-05	94578	94572	1.64%	100.00%	3.31	181.00	116.85	4747	116.85	181.00
Class 12	12-06	30577	30576	0.53%	100.00%	1.76	205.25	129.85	1537	129.85	205.25
Class 13	Total	10907	10595	0.18%		1.54	328.05	130.29	534	130.29	328.05
	13-07		9738	0.17%	91.91%	1.54	328.05	128.75	490	128.75	328.05
	13-08		680	0.01%	6.42%	28.66	160.94	122.14	35	122.14	160.94
	13-09		75	0.00%	0.71%	37.70	177.25	162.99	5	162.92	177.25
	13-10		65	0.00%	0.61%	38.36	200.62	161.51	4	162.92	200.62
	13-11		10	0.00%	0.09%	66.80	169.76	167.28	1	169.76	169.76
	13-12		8	0.00%	0.08%	65.04	209.22	207.60	1	209.22	209.22
	13-13		19	0.00%	0.18%	88.41	246.26	227.41	1	246.26	246.26
Class 14	14-05	1131	1128	0.02%	100.00%	12.13	101.19	71.21	58	71.21	101.19
Class 15	Total	68578	67708	1.18%		1.76	423.95	97.89	3388	97.89	423.95
	15-02		3071	0.05%	4.54%	4.63	49.60	34.61	157	34.61	49.60
	15-03		13617	0.24%	20.11%	6.17	55.34	26.90	682	26.90	55.34
	15-04		10013	0.17%	14.79%	7.50	93.04	57.10	507	57.10	93.04
	15-05		9057	0.16%	13.38%	12.57	104.72	73.85	465	73.85	104.72
	15-06		19507	0.34%	28.81%	13.23	135.80	93.04	987	93.04	135.80
	15-07		4164	0.07%	6.15%	19.62	130.95	100.09	214	100.09	130.95
	15-08		4781	0.08%	7.06%	1.76	266.32	162.70	242	162.70	266.32
	15-09		1264	0.02%	1.87%	1.98	345.91	182.26	64	182.32	345.91
	15-10		727	0.01%	1.07%	2.20	423.95	202.16	39	202.16	423.95
	15-11		489	0.01%	0.72%	2.20	239.86	166.85	25	167.11	239.86
	15-12		384	0.01%	0.57%	2.43	359.79	91.45	20	92.37	359.79
	15-13		341	0.01%	0.50%	2.65	322.10	61.29	18	61.29	322.10
15-14		293	0.01%	0.43%	3.09	131.40	51.72	15	52.91	131.40	

Page Left Blank Intentionally

STATISTICAL DISTRIBUTIONS FOR H5P DATA

The H5P data for all class-axle groups were used to generate best-fit statistical distributions using the ModelRisk software. Data from all stations were combined. Limited Analysis of Variance (ANOVA) showed that truck weights in different WIM stations did not belong to the same distribution. Best fit distributions were determined for each axle weight, axle spacing and the total weight in each truck class-axle category. ModelRisk reportedly utilizes the following information criteria to find the best fit distribution for each parameter:

- SIC (Schwarz Information Criterion), also known as Bayesian Information Criterion (BIC)
- AIC (Akaike Information Criterion)
- HQIC (Hannan-Quinn Information Criterion)

The fitting options within ModelRisk cannot directly accommodate bimodal (“double hump”) or multi-modal statistical distributions. However, many axle load and axle spacing distributions are in fact multi-modal. Therefore, when data warranted such considerations, a semi-manual approach was used to determine multi-modal best fit distributions. The following approach was used:

- A histogram of data was generated in MS Excel.
- ModelRisk® was used to find the best fit single-mode distributions.
- If the histogram indicated multi-modal (“multi-hump”) behavior, then the data was manually separated into grouping around each peak. Best fit single-mode distributions for each group were determined using ModelRisk. The number of data points within each grouping divided by the total number of data points is the probability (P) associated with the distribution in that grouping. For example, for a tri-modal distribution:

$$\text{Multi-Modal Distribution} = P_1 \times \text{Distribution}_1 + P_2 \times \text{Distribution}_2 + P_3 \times \text{Distribution}_3$$

- The resulting multi-modal distribution was plotted and compared with the histogram to make sure that the data agrees with the distribution.

All single-mode distributions for all class-axle groupings are shown in Appendix A. Results for class 9 trucks are shown below as well. Table 6 shows the single-mode best fit distributions for class 09 (5 axle truck). As stated earlier, not all single-mode distributions are appropriate. When the histogram indicated multimodal response, the multimodal distributions were determined as well and used in simulations in lieu of single-mode distributions. Table 7 shows the multi-modal distributions fit to class 9 data that were considered multi-modal. Appendix B includes all such multi-modal data for all classes. For reference, Table 8 shows typical shapes associated with different unimodal distributions.

Selected histogram and distribution plot for class 9 are shown in Table 9. More such plots are provided in Appendix C.

Table 6. Best Fit Single-Mode Distributions for Class 9 Trucks.

Class 09-05		
Wt. or Spacing	Distribution	Parameters*
Total Wt	Beta4	1.199, 6.460, 475.618, 1100.592
A axle Wt	Student3	96.110, 18.620, 15
A-B spacing**	Student3	51.296, 7.023, 3
B axle Wt	Student3	118.086, 18.667, 302
B-C spacing	Student3	12.761, 0.658, 5
C axle Wt	Student3	122.246, 19.266, 43
C-D spacing	Student3	100.460, 8.277, 6
D axle Wt	Student3	116.664, 18.978, 50
D-E spacing**	Student3	12.008, 0.444, 3
E axle Wt	Student3	121.745, 19.450, 34

* Parameters are determined using W-Card units. W-Card load data are given in 100kg's. W-Card spacing data are given in 100mm's. The parameters are used to generate the particular distributions, say beta4 or student3.

** The histogram is not unimodal. Use multi-mode distribution given in Table 7 instead.

Table 7. Best Fit Multi-Modal Distributions for Class 9 Spacings.

Class 09-05 AB spacing			
Distribution	Parameters*	Weight	% of Total
Student3	36.560, 2.952, 10	13483	7.58%
Logistic	50.746, 1.740	137860	77.51%
Student3	59.601, 2.069, 4	26514	14.91%

Class 09-05 DE spacing			
Distribution	Parameters*	Weight	% of Total
Gamma	362.838, 0.033	153114	86.09%
Student3	30.143, 0.943, 3	24743	13.91%

* Parameters are determined using W-Card units. W-Card load data are given in 100kg's. W-Card spacing data are given in 100mm's. The parameters are used to generate the particular distributions, say beta4 or student3.

Table 8. Typical Single Mode Statistical Distributions⁽³⁾

Distribution	Parameters	Chart	Distribution	Parameters	Chart
Beta4	a, b, min, max		Logistic	a, b	
Exponential	b		Lognormal	m, s	
Extreme Value Max	a, b		Normal	m, s	
Extreme Value Min	a, b		Pareto	q, a	
Gamma	a, b		Student3	m, s, n	
LogGamma	a, b, g		Weibull	a, b	

Table 9 – HSP Histograms and distributions for Class 9 trucks.



COPULAS

The motivation behind determining statistical distributions for each parameter in a truck class is to be able to run Monte Carlo simulations using those marginal distributions. One could perform such simulations assuming that the various axle loads and spacings are independent of each other. If such parameters were considered independent of each other, then the relationships between different axle loads and spacings, if any, would be ignored. Srinivas et al.⁽¹⁾ suggest that copulas be used to model the interdependence of truck load information.

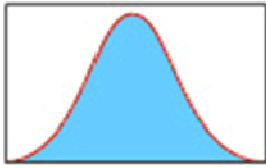
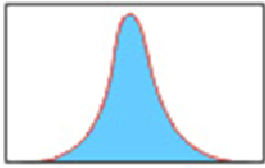
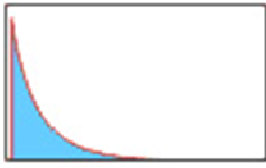
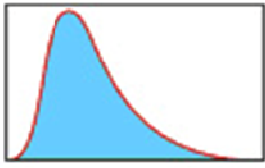
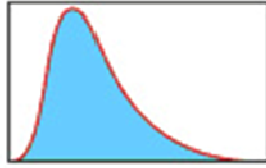
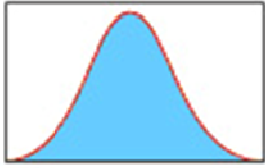
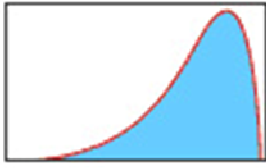
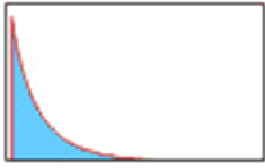
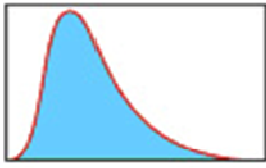
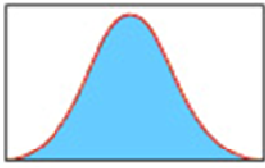
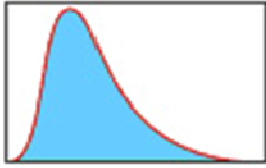
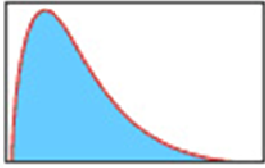
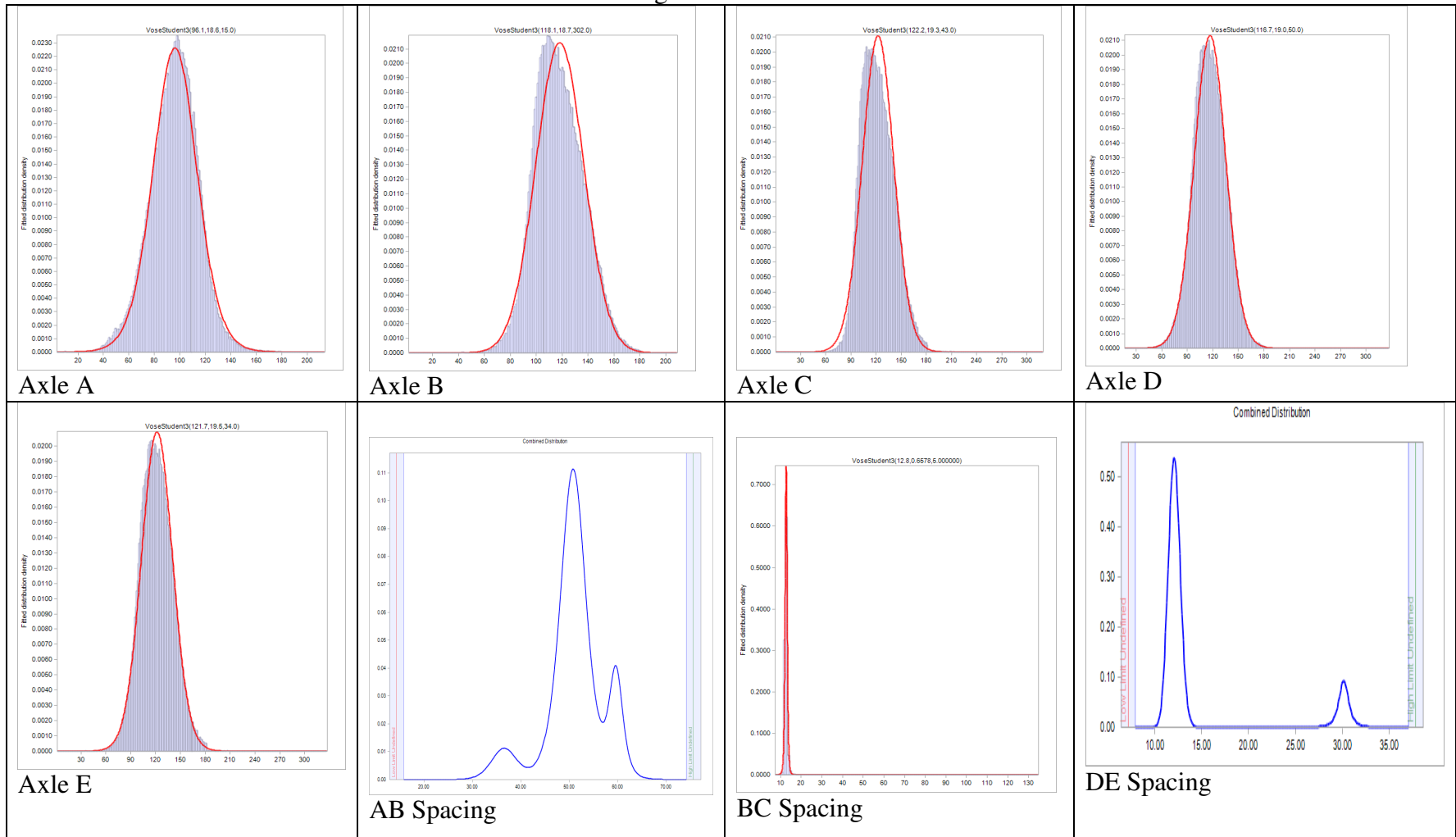
Copulas have been widely used in financial and insurance industries to assess financial risk in instruments such as the derivatives. Copulas were first introduced by Sklar in 1959^{(1), (7)}. Copula functions can completely describe the dependence between the variables involved. The multivariate distribution can be determined by linking the marginal distributions with the copula function.⁽¹⁾ There are many types of functions that can serve as copulas. Two prominent groups of copulas are Elliptical Copulas and Archimedean Copulas. The Gaussian and Student’s T copulas belong in the Elliptical group while Clayton, Gumbel and Frank copulas belong in the Archimedean group.⁽¹⁾ Empirical copulas are based on actual data and are not fit to particular mathematical functions.⁽⁸⁾

The ModelRisk software can determine best fit standard copulas based on data entered into an Excel spreadsheet. Alternatively, it can determine empirical copulas. The empirical copulas employed within ModelRisk are proprietary. According to the developer of the software, the ModelRisk copulas “based on resampling paired Dirichlet distributions, where each Dirichlet represents the univariate uncertainty of the empirical percentiles based on order statistics theory.” In this study, both approaches (standard and empirical copulas) were examined. Best fit copulas were determined (see Appendix D for results) and empirical copulas were utilized as well. Table 10 shows the 9-parameter (5 axle loads and 4 spacings) best fit copula correlation matrix for the Class 9 truck. However, based on simulations of axle weights and spacings for each truck class, it was determined that the empirical copulas (which utilize actual data each time) were best able to simulate total truck weight distributions when such simulations were compared with corresponding histograms. Therefore, empirical copulas were used for the Monte Carlo simulations. The Crystal Ball software was used for Monte Carlo simulations. Both Crystal Ball and ModelRisk conveniently run with MS Excel. So, copulas and distributions were determined in Excel using ModelRisk, and these were used by Crystal Ball to conduct simulations.

Table 10. The Best-Fit Student-T Coupla for Class 9 H5P Data

Class 09-05 Student-T Copula									
Correlation Matrix	1.000	0.075	0.456	0.155	0.283	0.111	0.321	0.161	0.183
	0.075	1.000	0.073	0.193	0.054	-0.042	0.080	0.399	0.026
	0.456	0.073	1.000	0.139	0.697	0.072	0.596	0.167	0.472
	0.155	0.193	0.139	1.000	0.240	0.177	0.163	0.448	0.194
	0.283	0.054	0.697	0.240	1.000	0.059	0.491	0.176	0.546
	0.111	-0.042	0.072	0.177	0.059	1.000	-0.047	-0.037	-0.052
	0.321	0.080	0.596	0.163	0.491	-0.047	1.000	0.251	0.770
	0.161	0.399	0.167	0.448	0.176	-0.037	0.251	1.000	0.252
	0.183	0.026	0.472	0.194	0.546	-0.052	0.770	0.252	1.000
Parameter	9								

Page Left Blank Intentionally

MONTE CARLO SIMULATIONS

As a first step in the simulation effort, a MS Excel spreadsheet was setup to calculate bending moment and shear envelopes for any moving truck arrangements (up to 10 axles) using influence lines. A simple-span bridge condition with spans ranging from 20 ft to 250 ft was considered. Figure 2 shows the primary sheet for this Excel workbook. The simulations were run in this spreadsheet. The distributions and copulas were applied to axle loads and spacings. In addition, the 250-kip Wisconsin Permit Vehicle (WPV) was run, and the maximum moments and shears due to WPV were compared with the simulation results to determine the effect of WPV (as a percentile of the simulation results) for each truck class–axle grouping. Figure 3 shows the 250-kip WPV truck.

		Input Truck										
Input Cells		A Axle load	AB spacing	B Axle load	BC spacing	C Axle load	CD spacing	D Axle load	DE spacing	E Axle load	EF spacing	F Axle load
Simulation Cells		Kips	FT	Kips	FT	Kips	FT	Kips	FT	Kips	FT	Kips
		8	10	32	14	32	14	10	4	20	4	30

Maximum Moments and Shears due to Input truck on Simply Supported Bridge Spans				
Span (FT)	Max Moment (K-FT)	Max Shear (K)	WPV-Moment	WPV-Shear
20.0	245.9	52.0	415.5	84.0
30.0	457.9	69.9	720.3	98.9
40.0	704.7	80.1	1043.0	106.3
50.0	949.8	93.4	1380.7	114.0
60.0	1221.8	104.2	1729.9	133.2
70.0	1629.8	115.2	2081.3	149.0
80.0	2185.3	128.5	2586.4	161.4
90.0	2756.1	139.1	3172.1	169.6
100.0	3341.1	146.5	3845.2	178.8
110.0	3936.4	153.7	4506.6	184.8
120.0	4506.1	159.1	5164.3	190.5
130.0	5113.8	163.7	5835.8	195.6
140.0	5706.7	167.5	6492.5	200.3
150.0	6271.0	170.5	7166.9	203.2
160.0	6890.0	175.2	7844.0	205.1
170.0	7445.9	176.4	8464.9	207.3
180.0	8062.3	179.6	9167.9	209.2
190.0	8640.1	180.9	9788.0	211.4
200.0	9243.2	183.8	10467.5	214.3
210.0	9796.6	184.6	11157.8	217.4
220.0	10420.5	186.6	11823.2	217.7
230.0	11018.5	189.3	12519.1	218.7
240.0	11570.1	189.7	13184.3	219.7
250.0	12178.1	191.9	13859.5	220.6

Total Length of Truck	80	FT (from Front axle to back axle)
Total Weight of Truck	221	kips
No. of Axles	10	
FHWA Bridge Formula	122.4	kips (for the entire truck)
Ratio FHWA WT/WT	0.55	

Figure 2. Spreadsheets for determining moment and shear envelopes due to any truck arrangement.

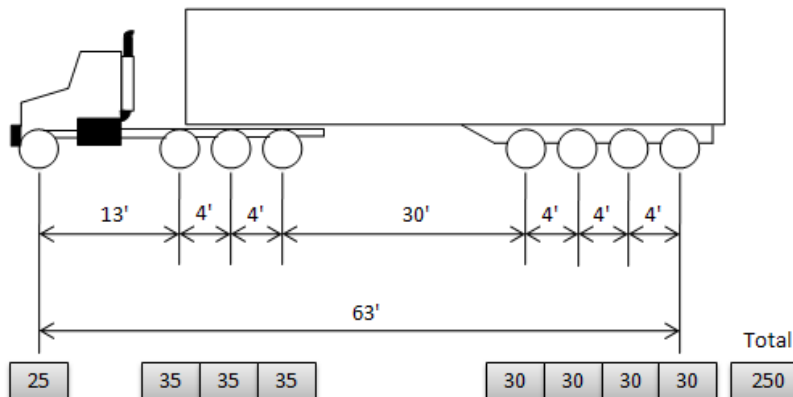

Figure 3. The 250-kip Wisconsin Permit Vehicle

Each simulation consisted of 10,000 runs using the determined distributions and empirical copulas. The results were then presented by Crystal Ball. The total computer run time for each simulation (for each class) was on the order of 80 minutes. Summary of results for Class 9 trucks are shown in Tables 11 and 12. Representative sheets from simulation report are shown in Figure 4. Summaries and reports for different class-axle configurations are shown in Appendix E.

Table 11. Summary of Moments - Monte Carlo Simulation results for H5P Class 9 Trucks.

Max Moment	Forecast Percentile (K-FT)										
	Span (FT)	0	10	20	30	40	50	60	70	80	90
20	133.3	193.6	207.2	217.5	226.8	235.2	244.0	253.8	264.7	279.9	371.2
30	252.8	334.6	352.8	368.4	381.4	395.4	409.8	424.3	441.4	465.6	610.7
40	372.3	473.2	498.5	520.0	539.8	558.9	578.2	599.6	623.4	657.0	960.5
50	525.7	633.6	665.5	694.5	721.8	748.3	774.1	803.1	834.7	882.8	1318.5
60	685.0	799.1	839.3	876.6	910.7	944.5	977.4	1013.5	1054.9	1115.3	1847.5
70	848.0	977.1	1026.1	1074.8	1115.8	1156.0	1196.5	1241.2	1293.9	1364.4	2430.2
80	1003.9	1203.8	1268.0	1324.5	1374.3	1425.7	1477.4	1530.9	1600.7	1692.4	2999.0
90	1220.3	1481.8	1557.0	1623.4	1684.0	1749.7	1812.7	1880.9	1964.3	2076.5	3562.1
100	1471.8	1769.5	1854.1	1931.6	2003.7	2079.4	2156.5	2236.9	2336.6	2465.3	4164.7
110	1748.2	2057.7	2154.3	2241.0	2324.4	2413.1	2503.9	2597.2	2710.2	2857.8	4709.7
120	2026.3	2346.4	2451.7	2549.5	2643.6	2745.8	2849.8	2954.0	3084.0	3255.2	5277.5
130	2300.9	2637.2	2749.7	2857.7	2965.7	3081.0	3195.0	3316.3	3459.2	3650.7	5894.9
140	2587.6	2924.3	3047.4	3163.0	3284.2	3413.1	3540.8	3673.3	3832.4	4044.3	6478.3
150	2869.0	3214.5	3345.1	3473.5	3605.0	3744.6	3889.8	4036.1	4205.9	4444.0	7046.3
160	3139.5	3502.3	3643.5	3784.3	3925.7	4080.3	4238.7	4394.7	4580.0	4841.7	7588.5
170	3409.9	3790.8	3942.1	4089.6	4249.1	4413.0	4585.8	4756.7	4954.0	5239.6	8182.1
180	3695.7	4081.0	4239.6	4397.6	4568.9	4746.7	4932.4	5116.1	5333.0	5634.1	8746.4
190	3960.7	4368.5	4538.5	4710.8	4888.5	5084.0	5283.2	5478.9	5707.2	6030.8	9321.1
200	4244.5	4655.1	4835.5	5012.2	5215.2	5413.3	5627.3	5837.9	6083.8	6422.8	9904.0
210	4534.0	4940.7	5133.7	5320.8	5531.4	5744.9	5972.3	6194.0	6456.5	6816.8	10494.2
220	4806.4	5231.6	5432.3	5631.3	5853.9	6080.0	6319.6	6559.6	6828.6	7218.8	11046.7
230	5081.8	5518.7	5732.0	5938.3	6175.7	6414.2	6669.6	6919.8	7203.6	7615.4	11655.0
240	5333.9	5807.5	6029.6	6246.3	6496.6	6747.1	7013.7	7275.5	7576.8	8004.6	12161.8
250	5618.0	6093.8	6330.0	6556.4	6817.6	7083.4	7363.7	7639.3	7955.4	8403.0	12781.6

Table 12. Summary of Shears - Monte Carlo Simulation results for H5P Class 9 Trucks.

Max Shear	Forecast Percentile (Kips)										
	0%	10%	20%	30%	40%	50%	60%	70%	80%	90%	100%
20	27.8	41.4	43.7	45.6	47.4	49.1	50.9	52.8	54.9	58.0	78.3
30	39.4	47.1	49.6	51.8	53.9	55.8	57.8	60.0	62.3	65.9	95.6
40	43.5	50.9	53.6	56.0	58.1	60.3	62.4	64.8	67.5	71.2	105.8
50	48.2	55.2	57.9	60.1	62.3	64.6	66.7	69.3	72.0	75.9	124.8
60	51.9	60.2	62.9	65.3	67.6	70.2	72.6	75.3	78.5	83.1	138.9
70	55.0	66.0	68.7	71.4	74.0	76.8	79.7	82.7	86.3	91.3	151.1
80	60.3	71.2	73.9	76.7	79.5	82.6	85.8	89.2	92.9	98.2	158.2
90	64.7	75.3	78.1	81.0	84.0	87.3	90.7	94.2	98.3	103.7	164.3
100	69.0	78.5	81.4	84.5	87.6	91.1	94.7	98.2	102.4	108.1	169.6
110	72.0	81.2	84.1	87.2	90.6	94.2	97.9	101.7	106.0	111.7	174.0
120	74.6	83.4	86.4	89.6	93.0	96.7	100.6	104.4	108.8	114.7	176.6
130	76.8	85.3	88.3	91.6	95.1	98.9	102.9	106.8	111.2	117.4	180.1
140	78.5	86.9	90.0	93.3	96.9	100.7	104.8	108.8	113.3	119.5	183.6
150	80.1	88.3	91.4	94.8	98.5	102.3	106.5	110.6	115.1	121.5	185.4
160	82.0	89.5	92.7	96.1	99.8	103.8	108.0	112.1	116.7	123.2	186.7
170	82.7	90.5	93.8	97.2	101.0	105.0	109.3	113.5	118.2	124.7	188.4
180	83.7	91.5	94.8	98.2	102.1	106.1	110.4	114.7	119.4	126.1	189.3
190	84.8	92.4	95.6	99.2	103.1	107.2	111.5	115.8	120.5	127.3	191.9
200	85.9	93.1	96.4	100.0	103.9	108.0	112.3	116.7	121.6	128.3	192.8
210	86.8	93.8	97.1	100.7	104.7	108.9	113.2	117.5	122.4	129.3	194.1
220	87.4	94.4	97.8	101.4	105.4	109.5	114.0	118.4	123.3	130.2	195.0
230	87.9	95.0	98.3	102.0	106.1	110.3	114.7	119.1	124.0	131.0	195.9
240	89.0	95.5	98.9	102.6	106.7	110.8	115.3	119.8	124.6	131.8	195.9
250	89.6	96.0	99.4	103.1	107.2	111.4	115.9	120.4	125.3	132.4	197.2

Moments and shear effects of WPV loads are compared with H5P simulation results in Tables 13 and 14. The WPV percentiles (with respect to H5P) were determined by comparing moments and shear due to WPV with the tabular percentile values for each class. However, to improve accuracy between 90 and 100 percentiles, analyses were run between 90 and 100 percentiles at 1 percentile increments. Therefore, interpolations were made within 1-percentile increments. Tables 13 and 14 include percentiles of H5P and “total” data. The term “total” refers to all trucks within that class. Since H5P data have the heaviest overall weights in that class, it is reasonable to assume that the effects due to H5P vehicles will result in higher moments and shears compared to the remaining 95% of trucks in that class. Therefore, the “total” percentile is estimated through the following relationship:

$$\text{Total percentile} = 95 + (\text{H5P percentile}) \times 0.05$$

Figures 5 and 6 show plots of WPV results versus span length (in percentiles of H5P simulations). For moments, the WPV results fall below 100 percentile of class 9 H5P results for span lengths 40 through 140 ft. The WPV shear results also fall below 100 percentile for spans 40 through 60 ft. However, in both cases, the H5P percentiles never reach below 99.7. Tables 15 and 16 (as well as Figures 7 and 8) compare results for all classes. For moments and shears, the lowest percentiles belong to classes 07-05, 13-07, 10-06 and 11-05. However, the lowest H5P percentiles do not go below 96 percentile.

Forecast: Max Moment (Span 100)

Entire range is from 1387.9 to 4139.1
 Base case is 1771.5
 After 10,000 trials, the std. error of the mean
 is 2.7

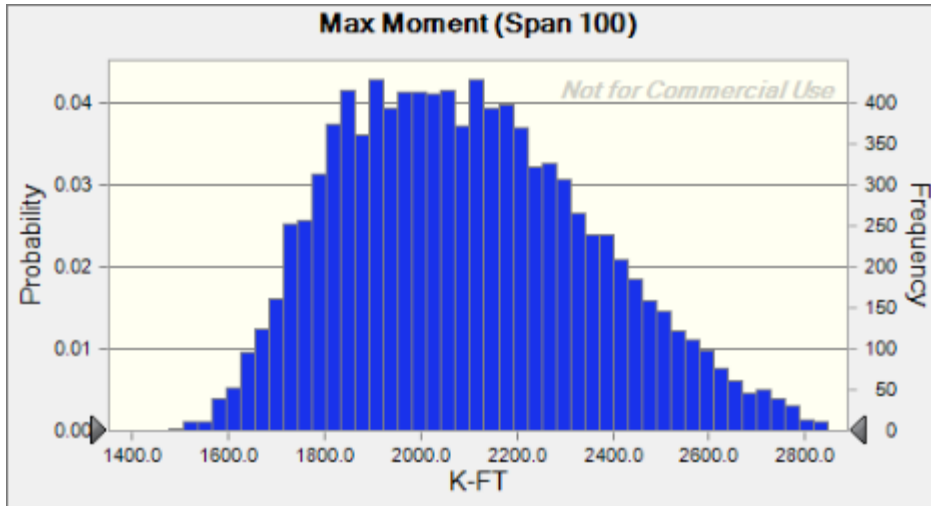

	Forecast values
Trials	10,000
Mean	2101.1
Median	2077.9
Mode	---
Standard Deviation	266.5
Variance	71038.2
Skewness	0.4926
Kurtosis	3.18
Coeff. of Variability	0.1269
Minimum	1387.9
Maximum	4139.1
Range Width	2751.2
Mean Std. Error	2.7

Forecast: Max Moment (Span 100) (cont'd)

Percentiles:	Forecast values
0%	1387.9
10%	1774.9
20%	1857.6
30%	1932.9
40%	2004.3
50%	2077.9
60%	2153.0
70%	2231.8
80%	2327.4
90%	2462.6
100%	4139.1

Figure 4. Selections from Simulation Report for H5P Class 9 Truck.

Table 13. Summary of Moments – WPV Data Compared With Monte Carlo Simulation Results for H5P Class 9 Trucks.

Max Moment	WPV		
Span (FT)	Moment (k-ft)	Percentile of H5P	Percentile of Total
20	415.5	100.00%	100.00%
30	720.3	100.00%	100.00%
40	1043.0	100.00%	100.00%
50	1380.7	100.00%	100.00%
60	1729.9	99.80%	99.99%
70	2081.3	99.61%	99.98%
80	2586.4	99.62%	99.98%
90	3172.1	99.68%	99.98%
100	3845.2	99.77%	99.99%
110	4506.6	99.86%	99.99%
120	5164.3	99.93%	100.00%
130	5835.8	99.97%	100.00%
140	6492.5	100.00%	100.00%
150	7166.9	100.00%	100.00%
160	7844.0	100.00%	100.00%
170	8464.9	100.00%	100.00%
180	9167.9	100.00%	100.00%
190	9788.0	100.00%	100.00%
200	10467.5	100.00%	100.00%
210	11157.8	100.00%	100.00%
220	11823.2	100.00%	100.00%
230	12519.1	100.00%	100.00%
240	13184.3	100.00%	100.00%
250	13859.5	100.00%	100.00%

Table 14. Summary of Shears – WPV Data Compared With Monte Carlo Simulation Results for Class 9 Trucks.

Max Shear	WPV		
Span	Shear (kips)	Percentile of H5P	Percentile of Total
20	84.0	100.00%	100.00%
30	98.9	100.00%	100.00%
40	106.3	100.00%	100.00%
50	114.0	99.73%	99.99%
60	133.2	99.87%	99.99%
70	149.0	99.96%	100.00%
80	161.4	100.00%	100.00%
90	169.6	100.00%	100.00%
100	178.8	100.00%	100.00%
110	184.8	100.00%	100.00%
120	190.5	100.00%	100.00%
130	195.6	100.00%	100.00%
140	200.3	100.00%	100.00%
150	203.2	100.00%	100.00%
160	205.1	100.00%	100.00%
170	207.3	100.00%	100.00%
180	209.2	100.00%	100.00%
190	211.4	100.00%	100.00%
200	214.3	100.00%	100.00%
210	217.4	100.00%	100.00%
220	217.7	100.00%	100.00%
230	218.7	100.00%	100.00%
240	219.7	100.00%	100.00%
250	220.6	100.00%	100.00%

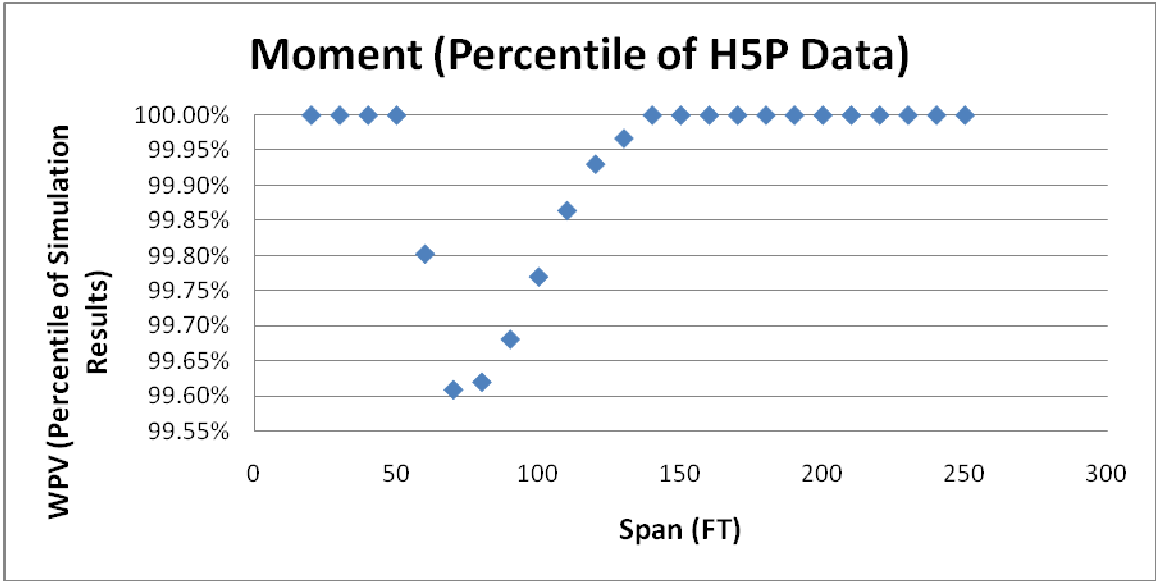

Figure 5. Wisconsin Permit Vehicle Moment Results Compared to H5P Class 9 Truck Simulations

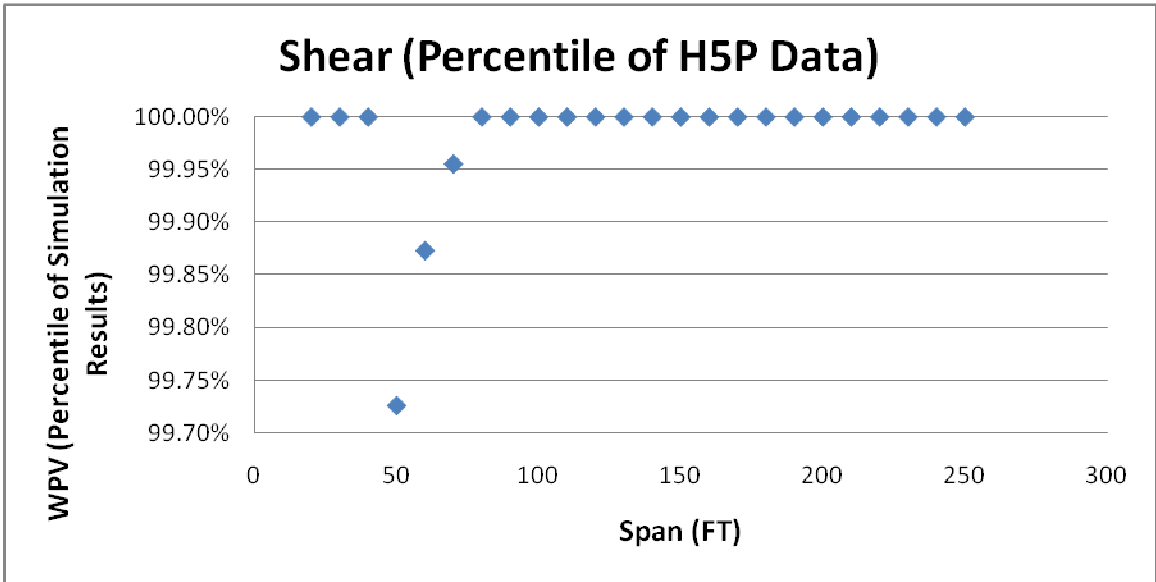

Figure 6. Wisconsin Permit Vehicle Shear Results Compared to H5P Class 9 Truck Simulations

Table 15. Moments (as Percentile of H5P Data) on Simply Supported Bridge Due to WPV Loading

Span (ft)	Class 05-06	Class 06-03	Class 07-04	Class 07-05	Class 08-03	Class 08-04	Class 09-05	Class 10-06	Class 11-05	Class 12-06	Class 13-07	Class 15-03	Class 15-04	Class 15-05	Class 15-06
20	100.0	99.4	99.2	99.0	100.0	100.0	100.0	99.3	100.0	100.0	99.2	100.0	100.0	100.0	100.0
30	100.0	99.6	99.3	98.5	100.0	100.0	100.0	99.5	100.0	100.0	99.1	100.0	100.0	100.0	100.0
40	100.0	99.7	99.3	98.0	100.0	100.0	100.0	99.5	100.0	100.0	99.0	100.0	100.0	100.0	100.0
50	100.0	99.8	99.2	97.1	100.0	100.0	100.0	99.2	100.0	100.0	98.4	100.0	100.0	100.0	100.0
60	100.0	99.8	99.2	96.6	100.0	100.0	99.8	99.0	100.0	100.0	97.3	100.0	100.0	100.0	100.0
70	100.0	99.9	99.2	96.0	100.0	100.0	99.6	97.9	100.0	100.0	96.3	100.0	100.0	100.0	100.0
80	100.0	100.0	99.3	98.4	100.0	100.0	99.6	98.4	100.0	100.0	96.6	100.0	100.0	100.0	100.0
90	100.0	100.0	99.5	99.3	100.0	100.0	99.7	99.0	100.0	100.0	97.1	100.0	100.0	100.0	100.0
100	100.0	100.0	99.7	99.8	100.0	100.0	99.8	99.2	100.0	100.0	97.6	100.0	100.0	100.0	100.0
110	100.0	100.0	99.8	100.0	100.0	100.0	99.9	99.3	100.0	100.0	98.0	100.0	100.0	100.0	100.0
120	100.0	100.0	99.9	100.0	100.0	100.0	99.9	99.4	100.0	100.0	98.2	100.0	100.0	100.0	100.0
130	100.0	100.0	100.0	100.0	100.0	100.0	100.0	99.5	100.0	100.0	98.4	100.0	100.0	100.0	100.0
140	100.0	100.0	100.0	100.0	100.0	100.0	100.0	99.5	100.0	100.0	98.5	100.0	100.0	100.0	100.0
150	100.0	100.0	100.0	100.0	100.0	100.0	100.0	99.6	100.0	100.0	98.8	100.0	100.0	100.0	100.0
160	100.0	100.0	100.0	100.0	100.0	100.0	100.0	99.7	100.0	100.0	98.9	100.0	100.0	100.0	100.0
170	100.0	100.0	100.0	100.0	100.0	100.0	100.0	99.7	100.0	100.0	98.9	100.0	100.0	100.0	100.0
180	100.0	100.0	100.0	100.0	100.0	100.0	100.0	99.7	100.0	100.0	99.0	100.0	100.0	100.0	100.0
190	100.0	100.0	100.0	100.0	100.0	100.0	100.0	99.7	100.0	100.0	99.0	100.0	100.0	100.0	100.0
200	100.0	100.0	100.0	100.0	100.0	100.0	100.0	99.7	100.0	100.0	99.0	100.0	100.0	100.0	100.0
210	100.0	100.0	100.0	100.0	100.0	100.0	100.0	99.8	100.0	100.0	99.1	100.0	100.0	100.0	100.0
220	100.0	100.0	100.0	100.0	100.0	100.0	100.0	99.8	100.0	100.0	99.1	100.0	100.0	100.0	100.0
230	100.0	100.0	100.0	100.0	100.0	100.0	100.0	99.8	100.0	100.0	99.1	100.0	100.0	100.0	100.0
240	100.0	100.0	100.0	100.0	100.0	100.0	100.0	99.8	100.0	100.0	99.1	100.0	100.0	100.0	100.0
250	100.0	100.0	100.0	100.0	100.0	100.0	100.0	99.8	100.0	100.0	99.1	100.0	100.0	100.0	100.0

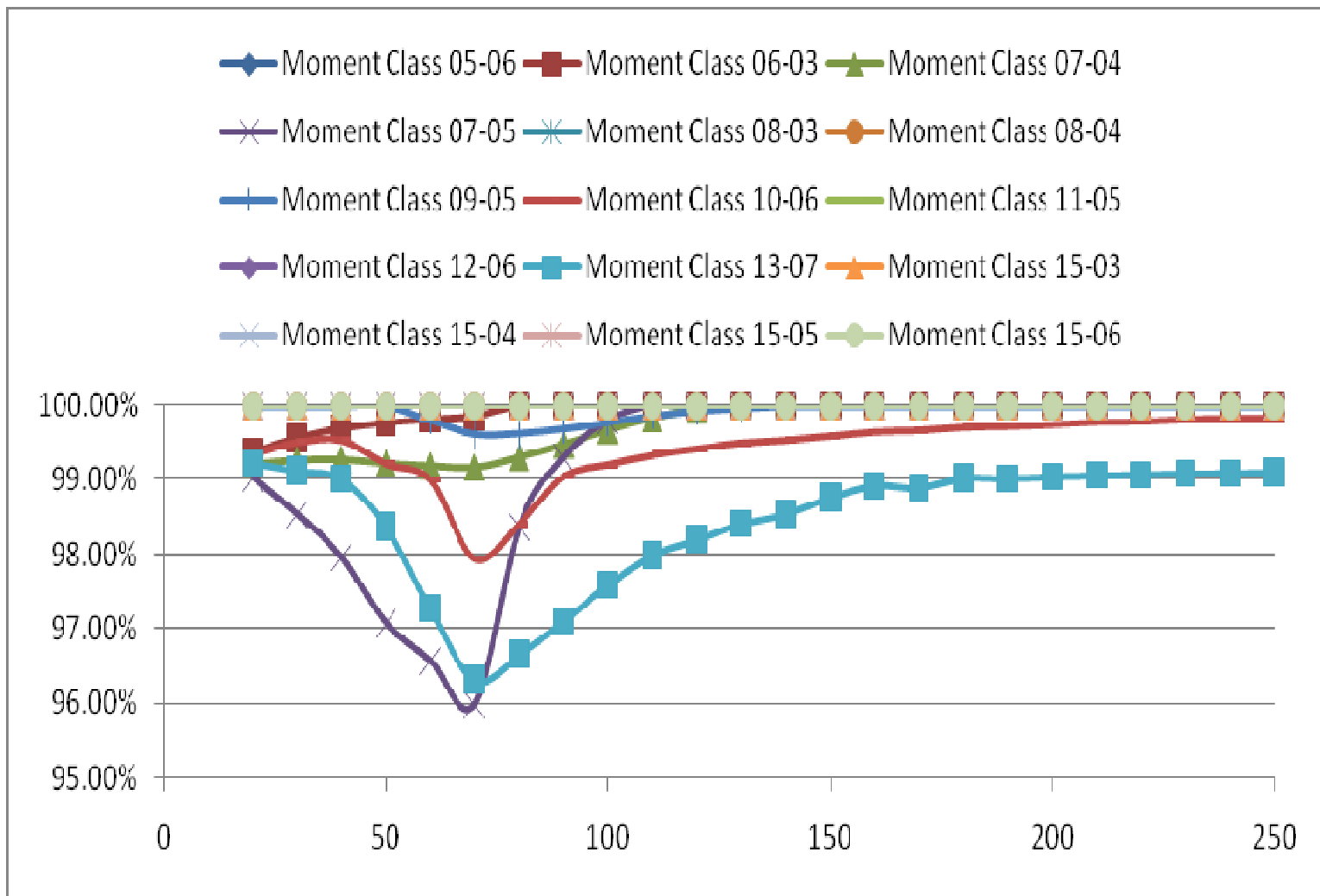

Figure 7. Plot of WPV moments as percentile of H5P data versus span length (ft) in each truck class.

Table 16. Shears (as Percentile of H5P Data) on Simply Supported Bridge Due to WPV Loading

Span (ft)	Class 05-06	Class 06-03	Class 07-04	Class 07-05	Class 08-03	Class 08-04	Class 09-05	Class 10-06	Class 11-05	Class 12-06	Class 13-07	Class 15-03	Class 15-04	Class 15-05	Class 15-06
20	100.0	99.4	99.1	98.0	100.0	100.0	100.0	99.3	100.0	100.0	99.0	100.0	100.0	100.0	100.0
30	100.0	99.7	99.2	97.8	100.0	100.0	100.0	99.3	100.0	100.0	99.0	100.0	100.0	100.0	100.0
40	100.0	99.8	99.2	96.6	100.0	100.0	100.0	98.7	100.0	100.0	98.1	100.0	100.0	100.0	100.0
50	100.0	100.0	99.2	97.2	100.0	100.0	99.7	97.8	100.0	100.0	97.2	100.0	100.0	100.0	100.0
60	100.0	100.0	99.5	99.5	100.0	100.0	99.9	99.1	100.0	100.0	98.4	100.0	100.0	100.0	100.0
70	100.0	100.0	99.8	100.0	100.0	100.0	100.0	99.3	100.0	100.0	99.0	100.0	100.0	100.0	100.0
80	100.0	100.0	99.9	100.0	100.0	100.0	100.0	99.4	100.0	100.0	99.1	100.0	100.0	100.0	100.0
90	100.0	100.0	100.0	100.0	100.0	100.0	100.0	99.5	100.0	100.0	99.1	100.0	100.0	100.0	100.0
100	100.0	100.0	100.0	100.0	100.0	100.0	100.0	99.6	100.0	100.0	99.2	100.0	100.0	100.0	100.0
110	100.0	100.0	100.0	100.0	100.0	100.0	100.0	99.7	100.0	100.0	99.2	100.0	100.0	100.0	100.0
120	100.0	100.0	100.0	100.0	100.0	100.0	100.0	99.7	100.0	100.0	99.2	100.0	100.0	100.0	100.0
130	100.0	100.0	100.0	100.0	100.0	100.0	100.0	99.8	100.0	100.0	99.2	100.0	100.0	100.0	100.0
140	100.0	100.0	100.0	100.0	100.0	100.0	100.0	99.8	100.0	100.0	99.3	100.0	100.0	100.0	100.0
150	100.0	100.0	100.0	100.0	100.0	100.0	100.0	99.8	100.0	100.0	99.3	100.0	100.0	100.0	100.0
160	100.0	100.0	100.0	100.0	100.0	100.0	100.0	99.8	100.0	100.0	99.2	100.0	100.0	100.0	100.0
170	100.0	100.0	100.0	100.0	100.0	100.0	100.0	99.9	100.0	100.0	99.2	100.0	100.0	100.0	100.0
180	100.0	100.0	100.0	100.0	100.0	100.0	100.0	99.9	100.0	100.0	99.2	100.0	100.0	100.0	100.0
190	100.0	100.0	100.0	100.0	100.0	100.0	100.0	99.9	100.0	100.0	99.2	100.0	100.0	100.0	100.0
200	100.0	100.0	100.0	100.0	100.0	100.0	100.0	99.9	100.0	100.0	99.2	100.0	100.0	100.0	100.0
210	100.0	100.0	100.0	100.0	100.0	100.0	100.0	100.0	100.0	100.0	99.3	100.0	100.0	100.0	100.0
220	100.0	100.0	100.0	100.0	100.0	100.0	100.0	100.0	100.0	100.0	99.3	100.0	100.0	100.0	100.0
230	100.0	100.0	100.0	100.0	100.0	100.0	100.0	100.0	100.0	100.0	99.2	100.0	100.0	100.0	100.0
240	100.0	100.0	100.0	100.0	100.0	100.0	100.0	100.0	100.0	100.0	99.2	100.0	100.0	100.0	100.0
250	100.0	100.0	100.0	100.0	100.0	100.0	100.0	100.0	100.0	100.0	99.2	100.0	100.0	100.0	100.0

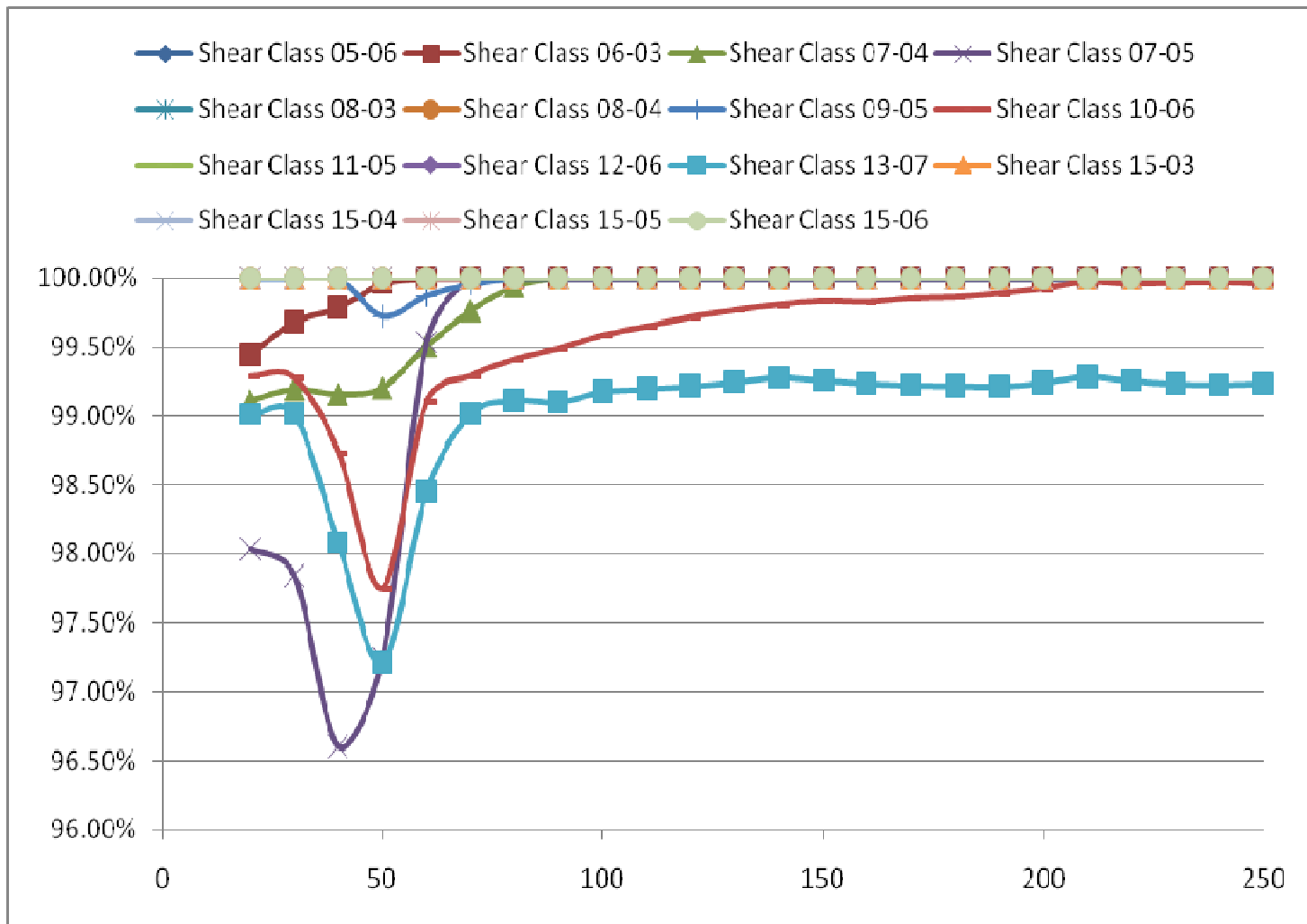

Figure . Plot of WPV shear as percentile of H5P data versus span length (ft) in each truck class.

SUMMARY AND CONCLUSIONS

This study involved statistical evaluation of heavy truck loads that were recorded using Weigh-In-Motion stations located throughout the State of Wisconsin. All records (just under 6 million vehicles) were collected within a one-year period (2007). FHWA trucks Classes 5 through 15 were retained. Vehicle classes 4 (buses) or less represent smaller vehicles and buses, and were thus excluded from analyses.

If a truck class contained multiple numbers of axles, then that class was further sub-divided such that each sub-group would contain only one particular number of axles. For example, Classes 08-03 and 08-04 contained class 08 vehicles with 3- and 4-axles, respectively. Data in each class-axle groupings were sorted based on gross vehicle weight, and the heaviest 5 percent (H5P) of truck records in each group were separated and analyzed. Statistical analyses were performed on the H5P data.

Using the H5P data, best-fit unimodal and/or multimodal distributions (“marginal” distributions) were determined for each axle weight and spacing in each truck class-axle group. Furthermore, copulas were determined to allow multivariate Monte Carlo simulations. Copulas help perform multivariate simulations while maintaining interdependence between various marginal distributions.

Selected Multivariate Analysis of Variance (ANOVA) was performed on a few class-axle groupings based on different WIM station results. ANOVA indicated that the various WIM stations records did not belong to the same distributions. Therefore, data from all stations were combined in various class-axle groupings.

Multivariate Monte Carlo simulations on H5P data in each class-axle group were conducted using Crystal Ball and ModelRisk software programs within Microsoft Excel. A spreadsheet program was written to calculate maximum moments and shears in a simply supported beam with spans ranging from 20 ft to 250 ft. Each simulated vehicle was “marched” across the bridge to find maximum effects. Each simulation analysis consisted of 10,000 runs (i.e. 10,000 trucks automatically generated from marginal distributions and copulas). The maximum moments and shear for each of the spans and each of the 10,000 runs were calculated, and the different percentile values for the simulation results were determined. Maximum moments and shears associated with the 250-kip Wisconsin Permit Vehicle (WPV) were also calculated for each span length, and compared with simulation results.

The following observations are made:

- 1) Truck simulations for each class-axle grouping were performed and successfully tested for validity.
- 2) Some H5P axle loads and axle spacing distributions are multimodal, and multimodal marginal distributions must be used in such cases for proper simulations.

- 3) Empirical copulas provide more accurate simulations when compared to conventional copula functions determined by data fitting. All simulation results reported here are based on empirical copulas determined using the ModelRisk software.
- 4) The percentile results derived can be used to assess the relative impact of any truck arrangement compared to simulation results. Moments and shears due to the Wisconsin Permit Vehicle were, in all cases, above the 96 percentile mark for the H5P simulation data. This is approximately equivalent to the 99.8 percentile for all trucks in each class.
- 5) It is clear that the Wisconsin Permit Vehicle results completely envelope most of the longer span length results (at 100 percentile). However, at shorter spans and for some truck classes, the percentile mark is reduced. This indicates that the probability of exceeding the permit vehicle effects is not uniform across all span lengths in simply supported bridges.
- 6) The marginal distributions and copulas determined here can also be used to statistically assess heavy truck impact on bridges and pavements based any load-dependent metric.

The following recommendations are made for future studies:

- 1) Expand determination of marginal distributions and copulas to the entire dataset of trucks (not just H5P data).
- 2) With data from the item 1 above, detailed fatigue studies can be performed in much greater detail and precision that would otherwise not be feasible without such information.
- 3) Conduct statistical analyses using the existing H5P information developed in this study as well as data from recommendation No. 1 to enhance understanding of degree of reliability and performance in Portland cement concrete and asphalt pavements.

REFERENCES

- 1) Srinivas, S., Menon, D., and Prasad, A.M., “Multivariate Simulation and Multimodal Dependence Modeling of Vehicle Axle Weights and Copulas,” Journal of Transportation Engineering, ASCE, Vol. 132, No. 12, December 2006, pp. 945-955.
- 2) “Crystal Ball”, Software by Oracle, <http://www.oracle.com/crystalball/index.html>
- 3) “ModelRisk”, by Vose Software, <http://www.vosesoftware.com/modelrisk.htm>
- 4) Joe, H., “Multivariate Models and Dependence Concepts,” Chapman and Hall Publishers, London, 1997.
- 5) “Traffic Monitoring Guide,” Federal Highway Administration, available online at <http://www.fhwa.dot.gov/ohim/tmguid/index.htm>
- 6) Lu, Q., Harvey, J., Le, T., Lea, J., Quinley, R., Redo, D., and Avis, J., “Truck Traffic Analysis using Weigh-In-Motion (WIM) Data in California,” Report by Pavement Research Center, University of California, Berkeley, June 2002, available online at <http://www.its.berkeley.edu/pavementresearch/PDF/WIMreport.pdf>
- 7) Sklar, A., “Fonctions de repartition a n dimensions et leurs marges,” Publications de l’Institut de Statistique de l’Universit de Paris, Paris, 8, 1959, pp. 229-231.
- 8) Nelsen, R.B., “Introduction to Copulas”, Springer, 2nd edition, 2007.
- 9) Zhao, J. and Tabatabai, H., “Analysis of Permit Vehicle Loads in Wisconsin,” Wisconsin Highway Research Program, SPR # 0092-08-15, Report No. WHRP 09-03, September 2009, 183 pp.

Page Left Blank Intentionally

APPENDICES

APPENDIX A – SINGLE MODE DISTRIBUTIONS FIT TO H5P DATA

Parameters in tables below are determined using the W-Card units. W-Card load data are given in 100kg's. W-Card spacing data are given in 100 millimeters. The parameters are used to generate the particular distributions, say beta4 or student3.

Class 05-02		
	Distribution	Parameter
Total WT	Pareto	5.072, 112
A axle Wt	ExtValueMax	48.099, 12.648
A-B spacing	Beta4	43.016, 10.930, -44.146, 75.433
B axle Wt	Student3	80.686, 20.576, 4

Class 06-03		
	Distribution	Parameter
Total WT	Pareto	6.319, 242
A axle Wt	Beta4	15.674, 11612.592, -14.191, 74589.890
A-B spacing	Weibull	6.274, 56.650
B axle Wt	Lognormal	93.266, 22.463
B-C spacing	Student3	13.068, 1.010
C axle Wt	Logistic	106.152, 16.550

Class 07-04		
	Distribution	Parameter
Total WT	Pareto	8.876, 362
A axle Wt	Logistic	104.114, 13.917
A-B spacing	Beta4	1.837, 2.601, 21.775, 70.433
B axle Wt	Gamma	5.282, 13.980
B-C spacing	LogGamma	20.535, 0.086, 9.351
C axle Wt	Logistic	113.348, 14.730
C-D spacing	ExtValueMax	13.083, 1.156
D axle Wt	Logistic	116.513, 17.083

Class 07-05		
	Distribution	Parameter
Total WT	Pareto	7.251, 423
A axle Wt	Beta4	8.925, 13.735, -2.502, 257.349
A-B spacing	Beta4	1.751, 3.203, 21.985, 54.277
B axle Wt	LogGamma	442.905, 0.010, -32.554
B-C spacing	ExtValueMax	12.705, 1.290
C axle Wt	Beta4	3.233, 5.304, 4.652, 232.345
C-D spacing	Student3	12.811, 0.832, 4
D axle Wt	Beta4	6.869, 7.690, 33.758, 227.107
D-E spacing	ExtValueMax	13.104, 1.107
E axle Wt	Beta4	8.903, 5.308, -40.405, 214.383

Class 08-03		
	Distribution	Parameter
Total WT	Pareto	3.904, 118
A axle Wt	Student3	42.156, 15.850, 3
A-B spacing	Student3	38.876, 4.714, 3
B axle Wt	ExtValueMax	55.661, 14.745
B-C spacing	ExtValueMax	64.872, 12.147
C axle Wt	ExtValueMax	38.596, 17.280

Class 08-04		
	Distribution	Parameter
Total WT	Pareto	6.375, 310
A axle Wt	Student3	75.075, 22.890, 4
A-B spacing	Student3	48.071, 7.728, 17
B axle Wt	Student3	92.363, 24.775, 4
B-C spacing	LogGamma	4.436, 0.528, 8.997
C axle Wt	ExtValueMax	87.326, 20.121
C-D spacing	ExtValueMin	91.230, 27.389
D axle Wt	Student3	93.330, 26.231, 3

Class 09-05		
	Distribution	Parameter
Total WT	Beta4	1.199, 6.460, 475.618, 1100.592
A axle Wt	Student3	96.110, 18.620, 15
A-B spacing	Student3	51.296, 7.023, 3
B axle Wt	Student3	118.086, 18.667, 302
B-C spacing	Student3	12.761, 0.658,5
C axle Wt	Student3	122.246, 19.266, 43
C-D spacing	Student3	100.460, 8.277, 6
D axle Wt	Student3	116.664, 18.978, 50
D-E spacing	Student3	12.008, 0.444, 3
E axle Wt	Student3	121.745, 19.450, 34

Class 10-06		
	Distribution	Parameter
Total WT	Pareto	6.540, 520
A axle Wt	Beta4	2.511, 4.840, 18.336, 189.973
A-B spacing	Student3	49.005, 9.908, 3
B axle Wt	Student3	106.728, 22.628, 9
B-C spacing	Student3	12.983, 0.579, 3
C axle Wt	Beta4	36.727, 851351.816, -26.316, 3414020.839
C-D spacing	ExtValueMin	91.972, 21.783
D axle Wt	Student3	83.462, 29.762, 24
D-E spacing	LogGamma	11.351, 0.163, 8.909
E axle Wt	Beta4	27.237, 873508.989, -21.011, 4238992.494
E-F spacing	Student3	13.036, 2.177, 3
F axle Wt	Student3	110.417, 28.874, 12

Class 10-07		
	Distribution	Parameter
Total WT	Pareto	7.373, 651
A axle Wt	LogGamma	65.098, 0.057, 24.552
A-B spacing	Logistic	43.890, 3.716
B axle Wt	Logistic	120.267, 10.376
B-C spacing	Logistic	12.955, 0.202
C axle Wt	Normal	129.623, 19.872
C-D spacing	Student3	81.542, 17.420, 3
D axle Wt	Beta4	2.161, 2.592, 39.634, 168.233
D-E spacing	Student3	17.944, 1.762, 3
E axle Wt	ExtValueMax	99.727, 20.590
E-F spacing	LogGamma	15.105, 0.057, 10.805
F axle Wt	Gamma	29.352, 3.764
F-G spacing	Weibull	1.581, 1.732, , Shift(10.95404)
G axle Wt	Normal	110.660, 21.374

Class 11-05		
	Distribution	Parameter
Total WT	Beta4	1.117, 5.053, 529.866, 835.361
A axle Wt	Logistic	95.951, 6.792
A-B spacing	Student3	37.940, 1.242, 7
B axle Wt	Gamma	86.695, 1.642
B-C spacing	Student3	64.068, 1.587, 4
C axle Wt	Lognormal	123.767, 15.600
C-D spacing	Student3	28.351, 1.027, 4
D axle Wt	Normal	118.306, 17.334
D-E spacing	Student3	66.706, 1.497, 3
E axle Wt	Beta4	108.507, 1141.899, -70.148, 1947.008

Class 12-06		
	Distribution	Parameter
Total WT	Pareto	11.052, 589
A axle Wt	Gamma	50.764, 1.982
A-B spacing	ExtValueMin	52.388, 5.481
B axle Wt	Logistic	95.867, 6.561
B-C spacing	Student3	12.688, 0.633, 7
C axle Wt	LogGamma	646.304, 0.007, 26.640
C-D spacing	Student3	62.452, 3.071, 3
D axle Wt	Gamma	80.493, 1.521
D-E spacing	ExtValueMax	26.566, 1.258
E axle Wt	Logistic	119.455, 8.115
E-F spacing	Student3	68.158, 1.971, 3
F axle Wt	Normal	112.065, 15.459

Class 13-07		
	Distribution	Parameter
Total WT	Beta4	0.661, 3.683, 584.000, 1491.003
A axle Wt	ExtValueMax	63.620, 19.769
A-B spacing	Logistic	43.650, 6.186
B axle Wt	Weibull	3.206, 94.958
B-C spacing	LogGamma	8.807, 0.167, 10.661
C axle Wt	Lognormal	119.225, 28.623
C-D spacing	LogGamma	3.065, 0.560, 10.982
D axle Wt	Gamma	16.486, 6.896
D-E spacing	ExtValueMin	102.909, 31.480
E axle Wt	Student3	97.655, 24.065, 4
E-F spacing	LogGamma	3.937, 0.396, 10.902
F axle Wt	ExtValueMax	97.654, 20.300
F-G spacing	LogGamma	5.075, 0.297, 10.825
G axle Wt	Student3	103.654, 30.899, 3

Class 13-08		
	Distribution	Parameter
Total WT	Pareto	9.657, 554
A axle Wt	Lognormal	51.593, 9.669
A-B spacing	Weibull	6.860, 45.874
B axle Wt	ExtValueMin	86.008, 17.015
B-C spacing	Student3	13.537, 1.142, 3
C axle Wt	Lognormal	90.285, 12.274
C-D spacing	Student3	13.849, 1.095, 3
D axle Wt	ExtValueMin	92.466, 15.024
D-E spacing	ExtValueMin	98.951, 28.225
E axle Wt	Logistic	74.373, 13.372
E-F spacing	Beta4	0.206, 0.493, 12.000, 126.156
F axle Wt	Lognormal	86.916, 14.491
F-G spacing	Student3	14.034, 2.151, 3
G axle Wt	Weibull	6.285, 83.725
G-H spacing	ExtValueMax	12.954, 1.756
H axle Wt	ExtValueMin	84.863, 15.126

Class 14-05		
	Distribution	Parameter
Total WT	Beta4	0.563, 1.492, 323.000, 463.040
A axle Wt	Beta4	0.980, 1.395, 46.000, 99.215
A-B spacing	ExtValueMin	63.048, 4.984
B axle Wt	ExtValueMax	75.486, 9.521
B-C spacing	ExtValueMax	13.409, 0.676
C axle Wt	Logistic	78.371, 6.969
C-D spacing	Normal	44.448, 9.211
D axle Wt	Logistic	62.965, 9.771
D-E spacing	LogGamma	36.307, 0.076, 32.094
E axle Wt	Normal	67.224, 16.137

Class 15-02		
	Distribution	Parameter
Total WT	Pareto	9.614, 157
A axle Wt	Normal	84.242, 14.122
A-B spacing	LogGamma	24.010, 0.069, 8.542
B axle Wt	Lognormal	90.646, 12.735

Class 15-03		
	Distribution	Parameter
Total WT	Pareto	5.404, 122
A axle Wt	ExtValueMax	40.927, 12.029
A-B spacing	LogGamma	11.435, 0.234, 5.355
B axle Wt	Beta4	1.295, 2.269, 4.824, 120.098
B-C spacing	Lognormal	39.389, 25.753
C axle Wt	Beta4	1.091, 1.475, 3.985, 116.223

Class 15-04		
	Distribution	Parameter
Total WT	Pareto	11.223, 259
A axle Wt	Beta4	3.633, 5.178, 27.235, 117.983
A-B spacing	LogGamma	17.147, 0.168, 5.293
B axle Wt	LogGamma	501.290, 0.009, -35.268
B-C spacing	LogGamma	49.970, 0.068, 1.513
C axle Wt	Gamma	35.025, 2.434
C-D spacing	Student3	13.645, 1.738, 3
D axle Wt	Logistic	88.467, 9.205

Class 15-05		
	Distribution	Parameter
Total WT	Pareto	12.986, 335
A axle Wt	Weibull	6.201, 80.240
A-B spacing	ExtValueMax	29.884, 10.039
B axle Wt	ExtValueMax	39.015, 10.856
B-C spacing	Student3	13.450, 2.914, 3
C axle Wt	Beta4	2.483, 2.747, 9.523, 124.589
C-D spacing	LogGamma	10.312, 0.220, 6.802
D axle Wt	Logistic	90.055, 9.208
D-E spacing	LogGamma	11.264, 0.186, 8.660
E axle Wt	ExtValueMin	98.567, 19.005

Class 15-06		
	Distribution	Parameter
Total WT	Pareto	20.726, 422
A axle Wt	Student3	51.397, 8.225, 4
A-B spacing	LogGamma	16.841, 0.184, 4.297
B axle Wt	Beta4	2.640, 4.557, 7.474, 131.302
B-C spacing	Beta4	1.284, 1.771, 5.969, 55.249
C axle Wt	Student3	77.323, 10.156, 5
C-D spacing	Student3	13.336, 2.431, 3
D axle Wt	Beta4	4.098, 3.065, -17.600, 131.861
D-E spacing	ExtValueMin	99.354, 12.872
E axle Wt	Student3	95.027, 13.588, 18
E-F spacing	LogGamma	11.535, 0.180, 7.870
F axle Wt	Logistic	97.774, 8.264

Class 15-07		
	Distribution	Parameter
Total WT	Pareto	17.4288, 454
A axle Wt	Logistic	51.453, 4.183
A-B spacing	LogGamma	25.235, 0.100, 3.961
B axle Wt	Student3	39.478, 12.886, 3
B-C spacing	Weibull	1.756, 28.886
C axle Wt	Beta4	1.758, 1.363, 12.128, 99.321
C-D spacing	LogGamma	37.958, 0.075, 0.989
D axle Wt	Logistic	83.963, 8.807
D-E spacing	LogGamma	7.692, 0.349, 5.389
E axle Wt	Beta4	0.903, 1.072, 7.000, 131.149
E-F spacing	ExtValueMin	90.466, 23.416
F axle Wt	ExtValueMin	97.525, 16.404
F-G spacing	Student3	12.751, 2.861, 3
G axle Wt	ExtValueMin	98.956, 18.609

Class 15-08		
	Distribution	Parameter
Total WT	Beta4	0.764, 2.546, 738.000, 1209.647
A axle Wt	Lognormal	77.625, 25.510
A-B spacing	ExtValueMax	39.597, 8.083
B axle Wt	Normal	94.314, 25.386
B-C spacing	Student3	13.547, 1.373, 3
C axle Wt	ExtValueMax	115.870, 21.220
C-D spacing	LogGamma	3.458, 0.452, 10.961
D axle Wt	Lognormal	127.651, 22.945
D-E spacing	ExtValueMin	104.976, 31.249
E axle Wt	Logistic	103.713, 9.740
E-F spacing	LogGamma	2.222, 0.764, 10.953
F axle Wt	Lognormal	109.536, 19.711
F-G spacing	LogGamma	3.632, 0.394, 10.927
G axle Wt	Logistic	108.665, 11.736
G-H spacing	LogGamma	4.969, 0.317, 10.847
H axle Wt	Student3	101.710, 23.056, 4

Class 15-09		
	Distribution	Parameter
Total WT	Pareto	6.736, 827
A axle Wt	ExtValueMax	66.075, 18.484
A-B spacing	Logistic	52.446, 6.638
B axle Wt	Gamma	12.378, 7.360
B-C spacing	LogGamma	7.509, 0.188, 11.414
C axle Wt	ExtValueMax	104.792, 22.057
C-D spacing	LogGamma	3.604, 0.608, 10.743
D axle Wt	ExtValueMax	106.020, 19.840
D-E spacing	Beta4	0.483, 1.486, 12.000, 126.042
E axle Wt	Lognormal	113.249, 22.949
E-F spacing	LogGamma	2.326, 1.122, 11.868
F axle Wt	Normal	112.828, 22.103
F-G spacing	Pareto	0.829, 12
G axle Wt	Student3	106.886, 24.434, 3
G-H spacing	LogGamma	5.922, 0.343, 10.551
H axle Wt	Student3	117.179, 29.608, 3
H-I spacing	LogGamma	0.861, 1.639, 13.000
I axle Wt	Student3	114.681, 31.167, 3

Class 15-10		
	Distribution	Parameter
Total WT	Beta4	0.715, 3.786, 917.000, 1933.536
A axle Wt	Logistic	80.212, 9.209
A-B spacing	Beta4	0.743, 1.612, 33.000, 93.235
B axle Wt	Lognormal	94.783, 25.992
B-C spacing	ExtValueMax	14.099, 1.728
C axle Wt	Student3	118.724, 34.632, 3
C-D spacing	LogGamma	2.013, 0.878, 11.865
D axle Wt	ExtValueMax	109.816, 21.801
D-E spacing	Beta4	0.472, 1.321, 12.000, 126.792
E axle Wt	Weibull	6.136, 120.739
E-F spacing	LogGamma	2.221, 0.960, 11.787
F axle Wt	ExtValueMax	100.852, 21.640
F-G spacing	Pareto	1.186, 12
G axle Wt	Logistic	106.837, 13.224
G-H spacing	Pareto	0.863, 12
H axle Wt	ExtValueMax	98.033, 21.769
H-I spacing	LogGamma	6.134, 0.316, 11.415
I axle Wt	ExtValueMax	100.608, 23.113
I-J spacing	Pareto	1.891, 12
J axle Wt	Gamma	17.142, 6.279

Class 15-11		
	Distribution	Parameter
Total WT	Beta4	0.630, 1.146, 758.000, 1103.671
A axle Wt	Logistic	51.571, 7.803
A-B spacing	ExtValueMax	42.485, 4.955
B axle Wt	Normal	62, 15.234
B-C spacing	Student3	13.844, 1.076, 3
C axle Wt	ExtValueMax	73.229, 15.870
C-D spacing	Pareto	6.013, 13
D axle Wt	Pareto	4.029, 66
D-E spacing	Student3	44.335, 12.907, 3
E axle Wt	Logistic	79.884, 10.425
E-F spacing	Pareto	9.587, 12
F axle Wt	Gamma	12.494, 7.194
F-G spacing	ExtValueMin	101.233, 24.295
G axle Wt	Student3	81.996, 14.224, 3
G-H spacing	Pareto	1.509, 12
H axle Wt	Logistic	82.370, 9.353
H-I spacing	LogGamma	3.723, 0.306, 11.730
I axle Wt	ExtValueMax	73.598, 17.832
I-J spacing	ExtValueMin	39.473, 8.163
J axle Wt	LogGamma	33.236, 0.100, 56.768
J-K spacing	Pareto	3.378, 12
K axle Wt	ExtValueMax	77.724, 21.445

Class 15-12		
	Distribution	Parameter
Total WT	Pareto	2.275, 419
A axle Wt	Lognormal	66.069, 27.562
A-B spacing	ExtValueMin	56.836, 4.764
B axle Wt	ExtValueMax	38.123, 19.391
B-C spacing	ExtValueMax	13.488, 0.970
C axle Wt	Pareto	1.436, 30
C-D spacing	Weibull	1.962, 47.812
D axle Wt	Weibull	2.073, 55.699
D-E spacing	LogGamma	0.669, 1.673, 13.000
E axle Wt	Pareto	1.877, 33
E-F spacing	LogGamma	3.968, 0.362, 11.712
F axle Wt	Pareto	1.950, 34
F-G spacing	ExtValueMin	47.439, 10.020
G axle Wt	Pareto	1.518, 21
G-H spacing	Pareto	1.282, 13
H axle Wt	Pareto	1.292, 22
H-I spacing	Pareto	5.497, 13
I axle Wt	Beta4	0.569, 2.181, 17.000, 159.586
I-J spacing	ExtValueMin	40.155, 9.755
J axle Wt	Pareto	2.162, 35
J-K spacing	Pareto	1.517, 11
K axle Wt	Pareto	2.200, 35
K-L spacing	Weibull	15.738, 14.794
L axle Wt	Pareto	2.308, 39

Class 15-13		
	Distribution	Parameter
Total WT	Pareto	2.107, 278
A axle Wt	Beta4	0.794, 1.329, 6.000, 187.291
A-B spacing	Weibull	2.348, 36.774
B axle Wt	Weibull	1.459, 64.382
B-C spacing	Pareto	2.828, 10
C axle Wt	Expon	46.944
C-D spacing	LogGamma	10.411, 0.191, 7.667
D axle Wt	Expon	40
D-E spacing	Weibull	1.837, 33.868
E axle Wt	Expon	30.944
E-F spacing	Pareto	2.140, 11
F axle Wt	Expon	34.833
F-G spacing	Gamma	25.399, 0.606
G axle Wt	Expon	32.611
G-H spacing	Pareto	1.155, 14
H axle Wt	Expon	33.5
H-I spacing	Student3	14.482, 2.452, 3
I axle Wt	Expon	34.222
I-J spacing	Student3	14.634, 2.406, 3
J axle Wt	Expon	36.611
J-K spacing	Pareto	1.209, 12
K axle Wt	Expon	36.667
K-L spacing	Student3	14.321, 2.140, 3
L axle Wt	Expon	32.5
L-M spacing	Student3	14.735, 3.581, 3
M axle Wt	Expon	33.722

Class 15-14		
	Distribution	Parameter
Total WT	Pareto	3.675, 240
A axle Wt	Expon	25.533
A-B spacing	Pareto	1.825, 10
B axle Wt	Expon	24.8
B-C spacing	Pareto	3.237, 12
C axle Wt	Expon	33.6
C-D spacing	Student3	14.619, 3.435, 3
D axle Wt	Expon	24.467
D-E spacing	Pareto	6.689, 13
E axle Wt	Expon	19.467
E-F spacing	ExtValueMax	13.508, 2.511
F axle Wt	Expon	16.733
F-G spacing	ExtValueMax	12.854, 3.458
G axle Wt	Weibull	1.690, 30.570
G-H spacing	ExtValueMax	14.260, 1.713
H axle Wt	Expon	19.733
H-I spacing	ExtValueMax	13.393, 3.174
I axle Wt	Weibull	1.591, 26.299
I-J spacing	Lognormal	14.736, 3.290
J axle Wt	Weibull	1.602, 26.846
J-K spacing	Student3	14.538, 1.598, 3
K axle Wt	Expon	18.067
K-L spacing	ExtValueMin	14.222, 1.147
L axle Wt	Expon	16.533
L-M spacing	Pareto	1.722, 10
M axle Wt	Lognormal	29.205, 22.034
M-N spacing	Pareto	3.243, 12
N axle Wt	Lognormal	27.484, 25.595

APPENDIX B – MULTI-MODAL DISTRIBUTIONS FIT TO H5P DATA

Parameters in tables below are determined using the W-Card units. W-Card load data are given in 100kg's. W-Card spacing data are given in 100 millimeters. The parameters are used to generate the particular distributions, say beta4 or student3.

Class 06-03 C axle Wt			
Distribution	Parameters	Weight	% of Total
Lognormal	14.177, 12.566	291	2.29%
ExtValueMax	96.553, 22.391	12439	97.71%

Class 07-04 AB spacing			
Distribution	Parameters	Weight	% of Total
LogGamma	702.611, 0.004, 6.432	329	25.06%
LogGamma	69.337, 0.043, 26.272	984	74.94%

Class 07-04 BC spacing			
Distribution	Parameters	Weight	% of Total
LogGamma	143.650, 0.014, 7.216	1064	81.04%
LogGamma	14.6129, 0.122, 15.386	249	18.96%

Class 07-05 AB spacing			
Distribution	Parameters	Weight	% of Total
Lognormal	28.005, 2.093	13696	93.07%
Lognormal	40.454, 2.894	1020	6.93%

Class 07-05 BC spacing			
Distribution	Parameters	Weight	% of Total
Gamma	294.816, 0.042	1546	64.79%
LogGamma	19.179, 0.063, 12.952	840	35.21%

Class 08-03 AB spacing			
Distribution	Parameters	Weight	% of Total
ExtValueMin	28.607, 1.694	1464	4.57%
Student3	38.658, 2.671, 4	27558	85.95%
ExtValueMax	48.298, 1.595	3039	9.48%

Class 08-03 BC spacing			
Distribution	Parameters	Weight	% of Total
Beta4	2.408, 2.876, 33.666, 129.705	18094	56.44%
Beta4	9.663, 14.697, 56.677, 77.441	13967	43.56%

Class 08-04 AB spacing			
Distribution	Parameters	Weight	% of Total
LogGamma	34.146, 0.050, 8.458	50	0.46%
Student3	38.254, 3.051, 4	2750	25.38%
Lognormal	51.493, 4.918	8036	74.16%

Class 08-04 BC spacing			
Distribution	Parameters	Weight	% of Total
Student3	13.112, 1.060, 4	8150	75.21%
Student3	104.894, 19.851, 3	2686	24.79%

Class 08-04 CD spacing			
Distribution	Parameters	Weight	% of Total
Student3	12.067, 0.790, 3	2605	24.04%
Student3	29.394, 3.057, 3	573	5.29%
Student3	98.363, 12.000, 5	7658	70.67%

Class 09-05 AB spacing

Distribution	Parameters	Weight	% of Total
Student3	36.560, 2.952, 10	13483	7.58%
Logistic	50.746, 1.740	137860	77.51%
Student3	59.601, 2.069, 4	26514	14.91%

Class 09-05 DE spacing

Distribution	Parameters	Weight	% of Total
Gamma	362.838, 0.033	153114	86.09%
Student3	30.143, 0.943, 3	24743	13.91%

Class 10-06 AB spacing

Distribution	Parameters	Weight	% of Total
ExtValueMax	12.797, 2.195	111	3.03%
ExtValueMin	37.427, 2.079	421	11.50%
LogGamma	359.674, 0.010, 20.535	3130	85.47%

Class 10-06 CD spacing

Distribution	Parameters	Weight	% of Total
ExtValueMax	13.285, 1.426	256	6.99%
Normal	59.531, 11.721	1349	36.84%
LogGamma	37.352, 0.074, 83.512	2057	56.17%

Class 10-06 DE spacing

Distribution	Parameters	Weight	% of Total
ExtValueMax	12.733, 1.193	3339	91.18%
ExtValueMax	27.161, 1.201	89	2.43%
LogGamma	9.193, 0.330, 32.217	234	6.39%

Class 10-06 EF spacing			
Distribution	Parameters	Weight	% of Total
ExtValueMax	12.643, 1.094	3449	94.18%
ExtValueMax	28.024, 3.610	117	3.19%
ValueMax	65.228, 17.759	96	2.62%

Class 12-06 AB spacing			
Distribution	Parameters	Weight	% of Total
Beta4	2.353, 3.614, 30.658, 38.592	180	11.71%
ExtValueMin	46.291, 1.174	316	20.56%
Logistic	51.654, 0.869	841	54.72%
LogGamma	24.650, 0.051, 56.163	200	13.01%

Class 12-06 CD spacing			
Distribution	Parameters	Weight	% of Total
Pareto	30.901, 13	29	1.89%
Logistic	62.415, 1.249	1508	98.11%

Class 13-07 AB spacing			
Distribution	Parameters	Weight	% of Total
ExtValueMin	40.644, 4.693	321	65.64%
LogGamma	13.143, 0.172, 45.796	168	34.36%

Class 13-07 BC spacing			
Distribution	Parameters	Weight	% of Total
ExtValueMax	13.121, 1.046	450	92.02%
Beta4	0.436, 0.551, 20.000, 58.311	39	7.98%

Class 13-07 DE spacing			
Distribution	Parameters	Weight	% of Total
LogGamma	17.308, 0.100, 9.932	75	15.34%
Weibull	4.313, 57.217	66	13.50%
Student3	106.678, 13.431, 3	348	71.17%

Class 15-03 AB spacing			
Distribution	Parameters	Weight	% of Total
Student3	13.243, 2.728, 3	494	72.43%
Normal	35.065, 3.463	62	9.09%
Student3	62.306, 23.141, 3	126	18.48%

Class 15-03 B axle Wt			
Distribution	Parameters	Weight	% of Total
Gamma	7.274, 1.976	136	19.94%
Lognormal	35.777, 6.650	285	41.79%
Lognormal	75.286, 14.723	261	38.27%

Class 15-03 BC spacing			
Distribution	Parameters	Weight	% of Total
Gamma	7.355, 3.038	360	52.79%
Student3	51.730, 13.706, 3	322	47.21%

Class 15-03 C axle Wt			
Distribution	Parameters	Weight	% of Total
Gamma	8.228, 1.617	202	29.62%
Logistic	35.322, 2.470	16	2.35%
ExtValueMax	65.305, 11.707	464	68.04%

Class 15-04 A axle Wt			
Distribution	Parameters	Weight	% of Total
Normal	52.485, 5.871	264	52.07%
Beta4	2.263, 5.039, 61.385, 114.047	243	47.93%

Class 15-04 AB spacing			
Distribution	Parameters	Weight	% of Total
Logistic	13.657, 1.444	227	44.77%
Student3	29.145, 2.936, 3	193	38.07%
LogGamma	7.604, 0.350, 36.294	87	17.16%

Class 15-04 B axle Wt			
Distribution	Parameters	Weight	% of Total
Weibull	2.939, 59.826	260	51.28%
Weibull	9.700, 40.001	247	48.72%

Class 15-04 BC spacing			
Distribution	Parameters	Weight	% of Total
Student3	20.145, 3.264, 3	220	43.39%
LogGamma	24.823, 0.124, 19.676	287	56.61%

Class 15-04 CD spacing			
Distribution	Parameters	Weight	% of Total
Student3	13.641, 1.010, 4	453	89.35%
Student3	59.419, 4.091, 4	54	10.65%

Class 15-05 A axle Wt			
Distribution	Parameters	Weight	% of Total
Normal	52.635, 6.318	96	20.65%
Lognormal	80.214, 9.294	369	79.35%

Class 15-05 AB spacing			
Distribution	Parameters	Weight	% of Total
Gamma	48.958, 0.279	23	4.95%
Student3	28.897, 3.060, 3	273	58.71%
Logistic	45.533, 1.723	139	29.89%
ExtValueMax	63.918, 4.014	30	6.45%

Class 15-05 B axle Wt			
Distribution	Parameters	Weight	% of Total
Gamma	20.785, 1.948	391	84.09%
Lognormal	71.824, 6.469	74	15.91%

Class 15-05 BD spacing			
Distribution	Parameters	Weight	% of Total
Logistic	13.389, 0.884	416	89.46%
LogGamma	17.320, 0.153, 19.241	49	10.54%

Class 15-05 C axle Wt			
Distribution	Parameters	Weight	% of Total
ExtValueMin	42.009, 6.008	163	35.05%
Beta4	1.582, 2.164, 46.221, 120.423	302	64.95%

Class 15-05 CD spacing			
Distribution	Parameters	Weight	% of Total
Logistic	13.123, 0.782	409	87.96%
ExtValueMin	56.663, 4.644	15	3.23%
Student3	100.305, 15.607, 3	41	8.82%

Class 15-05 DE spacing			
Distribution	Parameters	Weight	% of Total
Student3	14.024, 1.640, 4	402	86.45%
LogGamma	34.800, 0.100, 15.986	63	13.55%

Class 15-06 AB spacing			
Distribution	Parameters	Weight	% of Total
ExtValueMax	14.396, 3.840	578	58.56%
Weibull	9.185, 56.054	409	41.44%

Class 15-06 B axle Wt			
Distribution	Parameters	Weight	% of Total
Logistic	37.794, 4.220	611	61.90%
Logistic	77.493, 5.177	376	38.10%

Class 15-06 BC spacing			
Distribution	Parameters	Weight	% of Total
Student3	13.392, 1.646, 3	438	44.38%
Normal	36.745, 7.427	549	55.62%

Class 15-06 CD spacing			
Distribution	Parameters	Weight	% of Total
Student3	13.239, 1.689, 3	890	90.17%
LogGamma	15.571, 0.152, 16.332	97	9.83%

Class 15-06 D axle Wt			
Distribution	Parameters	Weight	% of Total
Weibull	3.427, 16.915	64	6.48%
Weibull	7.119, 47.009	318	32.22%
Lognormal	86.314, 12.394	605	61.30%

Class 15-06 DE spacing			
Distribution	Parameters	Weight	% of Total
ExtValueMax	12.575, 2.171	27	2.74%
ExtValueMax	46.317, 3.764	22	2.23%
Weibull	9.084, 100.131	938	95.04%

Class 15-06 EF spacing			
Distribution	Parameters	Weight	% of Total
Student3	12.515, 0.871, 6	759	76.90%
Student3	31.101, 1.759, 3	228	23.10%

APPENDIX C – COPULA RESULTS

The calculated best-fit copulas are presented here. But, the empirical copulas were used instead because they proved to be more accurate in simulations.

Class 05-02 Student-T Copula			
Correlation Matrix	1.000	-0.022	0.025
	-0.022	1.000	0.006
	0.025	0.006	1.000
Parameter	12		

Class 06-03 Student-T Copula					
Correlation Matrix	1.000	0.157	0.298	-0.058	-0.328
	0.157	1.000	0.026	-0.207	-0.082
	0.298	0.026	1.000	0.064	0.034
	-0.058	-0.207	0.064	1.000	0.146
	-0.328	-0.082	0.034	0.146	1.000
Parameter	9				

Class 07-04 Student-T Copula							
Correlation Matrix	1.000	-0.112	-0.051	0.133	-0.141	0.060	0.007
	-0.112	1.000	0.387	-0.126	0.108	0.391	-0.363
	-0.051	0.387	1.000	-0.190	-0.075	0.246	-0.501
	0.133	-0.126	-0.190	1.000	0.194	0.120	0.105
	-0.141	0.108	-0.075	0.194	1.000	0.027	0.072
	0.060	0.391	0.246	0.120	0.027	1.000	-0.087
	0.007	-0.363	-0.501	0.105	0.072	-0.087	1.000
Parameter	12						

Class 07-05 Student-T Copula									
Correlation Matrix	1.000	0.027	0.267	0.008	-0.125	0.070	0.111	0.027	0.056
	0.027	1.000	0.011	0.686	0.586	0.339	-0.037	0.536	-0.337
	0.267	0.011	1.000	0.010	0.118	0.030	-0.092	0.000	0.020
	0.008	0.686	0.010	1.000	0.586	0.353	-0.013	0.634	-0.266
	-0.125	0.586	0.118	0.586	1.000	0.223	0.058	0.407	-0.428
	0.070	0.339	0.030	0.353	0.223	1.000	0.115	0.269	-0.007
	0.111	-0.037	-0.092	-0.013	0.058	0.115	1.000	-0.068	0.226
	0.027	0.536	0.000	0.634	0.407	0.269	-0.068	1.000	-0.159
	0.056	-0.337	0.020	-0.266	-0.428	-0.007	0.226	-0.159	1.000
Parameter	17								

Class 08-03 Student-T Copula					
Correlation Matrix	1.000	-0.001	0.164	-0.039	0.048
	-0.001	1.000	0.170	0.110	-0.058
	0.164	0.170	1.000	0.112	0.301
	-0.039	0.110	0.112	1.000	0.344
	0.048	-0.058	0.301	0.344	1.000
Parameter	5				

Class 08-04 Student-T Copula							
Correlation Matrix	1.000	-0.032	0.133	0.223	0.112	-0.125	0.089
	-0.032	1.000	-0.216	-0.287	0.128	0.513	-0.018
	0.133	-0.216	1.000	0.334	0.163	-0.348	0.273
	0.223	-0.287	0.334	1.000	-0.058	-0.456	0.047
	0.112	0.128	0.163	-0.058	1.000	0.125	0.330
	-0.125	0.513	-0.348	-0.456	0.125	1.000	-0.030
	0.089	-0.018	0.273	0.047	0.330	-0.030	1.000
Parameter	8						

Class 09-05 Student-T Copula									
Correlation Matrix	1.000	0.075	0.456	0.155	0.283	0.111	0.321	0.161	0.183
	0.075	1.000	0.073	0.193	0.054	-0.042	0.080	0.399	0.026
	0.456	0.073	1.000	0.139	0.697	0.072	0.596	0.167	0.472
	0.155	0.193	0.139	1.000	0.240	0.177	0.163	0.448	0.194
	0.283	0.054	0.697	0.240	1.000	0.059	0.491	0.176	0.546
	0.111	-0.042	0.072	0.177	0.059	1.000	-0.047	-0.037	-0.052
	0.321	0.080	0.596	0.163	0.491	-0.047	1.000	0.251	0.770
	0.161	0.399	0.167	0.448	0.176	-0.037	0.251	1.000	0.252
	0.183	0.026	0.472	0.194	0.546	-0.052	0.770	0.252	1.000
Parameter	9								

Class 10-06 Student-T Copula											
Correlation Matrix	1.000	0.287	0.507	0.204	-0.013	0.040	0.393	0.373	-0.146	0.366	-0.225
	0.287	1.000	0.288	0.077	0.040	0.371	0.129	0.157	-0.141	0.260	-0.186
	0.507	0.288	1.000	0.075	0.291	0.194	0.271	0.140	0.032	0.163	-0.029
	0.204	0.077	0.075	1.000	0.102	0.042	0.253	0.281	0.131	0.275	0.132
	-0.013	0.040	0.291	0.102	1.000	0.132	0.027	-0.081	0.156	-0.040	0.221
	0.040	0.371	0.194	0.042	0.132	1.000	0.157	-0.236	-0.242	0.041	-0.307
	0.393	0.129	0.271	0.253	0.027	0.157	1.000	0.127	-0.048	0.210	-0.186
	0.373	0.157	0.140	0.281	-0.081	-0.236	0.127	1.000	-0.036	0.663	-0.025
	-0.146	-0.141	0.032	0.131	0.156	-0.242	-0.048	-0.036	1.000	-0.136	0.520
	0.366	0.260	0.163	0.275	-0.040	0.041	0.210	0.663	-0.136	1.000	-0.110
	-0.225	-0.186	-0.029	0.132	0.221	-0.307	-0.186	-0.025	0.520	-0.110	1.000
	Parameter	9									

Class 11-05 Student-T Copula									
Correlation Matrix	1.000	-0.042	0.166	-0.016	0.036	0.007	-0.013	0.054	-0.023
	-0.042	1.000	0.059	0.165	-0.025	0.356	0.254	0.156	0.092
	0.166	0.059	1.000	0.040	0.232	0.010	0.156	-0.007	0.000
	-0.016	0.165	0.040	1.000	0.164	0.381	0.042	0.608	0.123
	0.036	-0.025	0.232	0.164	1.000	0.064	0.047	0.097	0.186
	0.007	0.356	0.010	0.381	0.064	1.000	0.233	0.228	0.130
	-0.013	0.254	0.156	0.042	0.047	0.233	1.000	0.004	0.330
	0.054	0.156	-0.007	0.608	0.097	0.228	0.004	1.000	0.205
	-0.023	0.092	0.000	0.123	0.186	0.130	0.330	0.205	1.000
Parameter	14								

Class 12-06 Student-T Copula											
Correlation Matrix	1.000	0.224	0.116	0.161	0.110	0.025	-0.029	-0.064	-0.012	0.156	0.022
	0.224	1.000	-0.020	0.083	0.003	0.468	-0.071	-0.277	0.071	0.383	0.185
	0.116	-0.020	1.000	0.093	0.701	-0.001	0.320	0.155	0.195	-0.078	-0.056
	0.161	0.083	0.093	1.000	0.212	0.144	0.153	0.269	0.095	0.214	0.120
	0.110	0.003	0.701	0.212	1.000	-0.072	0.340	0.208	0.161	-0.122	-0.017
	0.025	0.468	-0.001	0.144	-0.072	1.000	0.028	-0.427	0.146	0.654	0.258
	-0.029	-0.071	0.320	0.153	0.340	0.028	1.000	0.090	0.244	0.030	0.213
	-0.064	-0.277	0.155	0.269	0.208	-0.427	0.090	1.000	0.021	-0.470	-0.239
	-0.012	0.071	0.195	0.095	0.161	0.146	0.244	0.021	1.000	0.095	0.432
	0.156	0.383	-0.078	0.214	-0.122	0.654	0.030	-0.470	0.095	1.000	0.288
	0.022	0.185	-0.056	0.120	-0.017	0.258	0.213	-0.239	0.432	0.288	1.000
Parameter	9										

Class 13-07 Student-T Copula													
Correlation Matrix	1.000	0.097	0.532	0.191	0.204	0.296	0.050	-0.154	0.211	0.251	0.111	0.293	0.119
	0.097	1.000	0.327	-0.090	0.059	0.372	-0.183	-0.134	0.136	0.429	-0.004	0.353	-0.018
	0.532	0.327	1.000	0.094	0.229	0.434	-0.047	-0.217	0.289	0.262	0.141	0.252	0.068
	0.191	-0.090	0.094	1.000	0.078	0.362	0.060	-0.051	-0.086	0.303	-0.003	0.291	-0.039
	0.204	0.059	0.229	0.078	1.000	0.139	0.507	0.014	0.325	0.038	0.359	0.063	0.262
	0.296	0.372	0.434	0.362	0.139	1.000	-0.209	-0.308	-0.030	0.544	-0.113	0.496	-0.068
	0.050	-0.183	-0.047	0.060	0.507	-0.209	1.000	0.240	0.322	-0.118	0.419	-0.065	0.364
	-0.154	-0.134	-0.217	-0.051	0.014	-0.308	0.240	1.000	0.086	-0.233	0.063	-0.040	0.035
	0.211	0.136	0.289	-0.086	0.325	-0.030	0.322	0.086	1.000	0.115	0.595	0.047	0.515
	0.251	0.429	0.262	0.303	0.038	0.544	-0.118	-0.233	0.115	1.000	0.101	0.637	0.101
	0.111	-0.004	0.141	-0.003	0.359	-0.113	0.419	0.063	0.595	0.101	1.000	0.064	0.680
	0.293	0.353	0.252	0.291	0.063	0.496	-0.065	-0.040	0.047	0.637	0.064	1.000	0.047
	0.119	-0.018	0.068	-0.039	0.262	-0.068	0.364	0.035	0.515	0.101	0.680	0.047	1.000
Parameter	8												

Class 15-03 Student-T Copula					
Correlation Matrix	1.000	0.034	0.289	-0.397	-0.372
	0.034	1.000	0.266	-0.067	-0.213
	0.289	0.266	1.000	-0.426	-0.695
	-0.397	-0.067	-0.426	1.000	0.432
	-0.372	-0.213	-0.695	0.432	1.000
Parameter	18				

Class 15-04 Student-T Copula							
Correlation Matrix	1.000	0.225	-0.036	-0.478	-0.102	0.121	-0.160
	0.225	1.000	0.361	-0.350	-0.384	0.478	-0.261
	-0.036	0.361	1.000	0.145	-0.404	0.353	-0.428
	-0.478	-0.350	0.145	1.000	0.036	0.094	0.034
	-0.102	-0.384	-0.404	0.036	1.000	-0.174	0.352
	0.121	0.478	0.353	0.094	-0.174	1.000	-0.139
	-0.160	-0.261	-0.428	0.034	0.352	-0.139	1.000
Parameter	8						

Class 15-05 Student-T Copula									
Correlation Matrix	1.000	-0.313	-0.356	-0.293	-0.410	-0.462	0.284	-0.329	0.201
	-0.313	1.000	0.173	0.182	0.396	0.535	-0.360	0.344	-0.242
	-0.356	0.173	1.000	0.150	0.123	0.283	-0.294	0.107	-0.118
	-0.293	0.182	0.150	1.000	0.297	0.332	-0.235	0.470	-0.210
	-0.410	0.396	0.123	0.297	1.000	0.403	-0.302	0.415	-0.637
	-0.462	0.535	0.283	0.332	0.403	1.000	-0.356	0.311	-0.190
	0.284	-0.360	-0.294	-0.235	-0.302	-0.356	1.000	-0.219	0.199
	-0.329	0.344	0.107	0.470	0.415	0.311	-0.219	1.000	-0.232
	0.201	-0.242	-0.118	-0.210	-0.637	-0.190	0.199	-0.232	1.000
Parameter	12								

Class 15-06 Student-T Copula											
Correlation Matrix	1.000	-0.017	0.039	-0.078	0.094	0.065	-0.037	-0.096	-0.130	-0.070	-0.115
	-0.017	1.000	0.725	-0.834	-0.030	0.227	-0.675	-0.533	0.007	0.118	0.054
	0.039	0.725	1.000	-0.662	0.138	0.241	-0.675	-0.467	-0.101	-0.040	-0.068
	-0.078	-0.834	-0.662	1.000	0.103	-0.150	0.650	0.601	-0.025	0.043	-0.073
	0.094	-0.030	0.138	0.103	1.000	0.051	0.098	0.088	-0.204	0.035	-0.271
	0.065	0.227	0.241	-0.150	0.051	1.000	-0.099	-0.247	-0.115	0.074	0.015
	-0.037	-0.675	-0.675	0.650	0.098	-0.099	1.000	0.483	-0.151	0.071	-0.237
	-0.096	-0.533	-0.467	0.601	0.088	-0.247	0.483	1.000	-0.053	-0.239	-0.063
	-0.130	0.007	-0.101	-0.025	-0.204	-0.115	-0.151	-0.053	1.000	0.156	0.144
	-0.070	0.118	-0.040	0.043	0.035	0.074	0.071	-0.239	0.156	1.000	-0.006
	-0.115	0.054	-0.068	-0.073	-0.271	0.015	-0.237	-0.063	0.144	-0.006	1.000
Parameter	17										

APPENDIX D – SIMULATION RESULTS

Class 05-02	Forecast Percentile										
	0%	10%	20%	30%	40%	50%	60%	70%	80%	90%	100%
Total Length of Truck	7.74	14.03	14.97	15.62	16.31	16.94	17.55	17.93	18.73	19.24	22.42
Total Weight of Truck	21.11	24.51	25.36	26.25	27.26	28.44	29.88	31.53	33.81	37.42	71.87
FHWA Bridge Formula	37.74	44.03	44.97	45.62	46.31	46.94	47.55	47.93	48.73	49.24	52.42
Ratio FHWA WT/WT	0.61	1.24	1.38	1.48	1.57	1.64	1.71	1.77	1.85	1.94	2.36

Class 05-02

Max Moment Span (FT)	Forecast Percentile (K-FT)										
	0%	10%	20%	30%	40%	50%	60%	70%	80%	90%	100%
20	64.2	77.5	83.4	89.7	94.1	98.4	103.2	108.8	115.4	125.3	254.4
30	96.3	116.8	127.4	135.3	143.2	149.5	157.5	165.2	175.0	191.1	406.2
40	131.4	173.1	187.0	198.2	208.3	218.8	229.4	241.0	256.0	280.5	601.6
50	179.2	241.1	257.9	271.7	283.8	296.7	310.9	326.4	347.9	380.3	799.6
60	245.5	308.8	328.5	344.6	358.6	374.2	392.0	413.0	439.5	481.7	1000.5
70	308.9	376.1	399.0	417.2	433.8	451.5	473.5	499.1	531.1	584.0	1195.8
80	370.7	443.8	469.1	489.6	508.6	529.3	555.0	585.7	623.6	685.7	1388.4
90	429.3	511.8	539.4	562.0	583.9	607.6	636.6	672.0	716.4	788.6	1586.5
100	486.1	579.8	609.7	634.2	658.6	685.6	718.9	758.3	809.3	890.6	1790.1
110	544.7	646.9	679.4	705.8	733.0	763.9	799.9	844.7	901.6	992.5	1984.1
120	605.1	714.6	748.9	777.9	807.8	841.8	880.9	931.3	994.1	1094.9	2180.8
130	667.4	782.0	818.7	849.7	882.9	920.3	963.4	1017.4	1086.6	1198.8	2380.2
140	725.1	849.4	888.5	921.5	957.4	997.7	1045.1	1104.0	1179.4	1301.6	2582.4
150	783.7	917.1	959.1	994.5	1033.1	1076.5	1127.1	1190.8	1272.6	1405.2	2766.9
160	843.2	984.6	1028.3	1066.3	1108.1	1154.8	1209.7	1277.2	1365.4	1507.6	2973.1
170	903.6	1052.2	1098.7	1138.0	1182.9	1231.3	1291.8	1363.5	1457.4	1611.9	3158.9
180	956.7	1119.4	1167.4	1210.4	1257.8	1309.8	1372.8	1449.9	1549.9	1713.8	3369.3
190	1018.5	1186.8	1237.6	1281.5	1332.9	1388.3	1455.6	1535.6	1642.3	1814.6	3556.5
200	1072.1	1254.0	1306.9	1354.0	1407.5	1466.2	1537.0	1623.0	1734.8	1919.3	3770.9
210	1129.1	1321.5	1376.9	1425.8	1483.1	1543.2	1620.2	1709.7	1828.2	2019.1	3959.4
220	1189.3	1388.7	1446.5	1498.1	1558.3	1623.9	1701.4	1795.6	1919.2	2124.9	4148.0
230	1245.0	1455.9	1515.3	1570.6	1632.0	1700.1	1783.1	1881.8	2014.0	2226.7	4367.9
240	1299.1	1522.8	1585.4	1641.9	1707.1	1777.2	1865.2	1968.8	2105.4	2326.7	4557.8
250	1362.4	1589.9	1654.8	1713.5	1782.7	1857.5	1947.6	2054.4	2196.8	2428.1	4747.7

Class 05-02

Max Shear	Forecast Percentile (Kips)										
	Span	0%	10%	20%	30%	40%	50%	60%	70%	80%	90%
20	11.8	15.6	16.8	17.8	18.7	19.6	20.6	21.6	23.0	25.2	54.1
30	15.3	18.7	19.8	20.7	21.6	22.5	23.6	24.8	26.4	29.0	60.0
40	17.3	20.2	21.2	22.2	23.0	24.0	25.1	26.5	28.2	31.0	62.9
50	18.2	21.0	22.1	23.0	23.8	24.8	26.0	27.4	29.3	32.2	64.7
60	18.9	21.6	22.6	23.5	24.4	25.4	26.6	28.1	30.0	33.1	66.0
70	19.3	22.1	23.0	23.9	24.8	25.8	27.1	28.6	30.6	33.7	66.7
80	19.7	22.4	23.3	24.2	25.1	26.2	27.4	28.9	30.9	34.2	67.2
90	19.9	22.6	23.6	24.4	25.4	26.4	27.7	29.2	31.2	34.5	67.8
100	20.1	22.8	23.7	24.6	25.6	26.6	27.9	29.4	31.5	34.8	68.3
110	20.1	22.9	23.9	24.7	25.7	26.8	28.1	29.6	31.7	35.0	68.5
120	20.2	23.1	24.0	24.9	25.8	26.9	28.2	29.8	31.8	35.2	68.8
130	20.3	23.2	24.1	25.0	25.9	27.0	28.3	29.9	32.0	35.4	69.0
140	20.3	23.3	24.2	25.0	26.0	27.1	28.4	30.0	32.1	35.5	69.3
150	20.4	23.3	24.3	25.1	26.1	27.2	28.5	30.1	32.2	35.6	69.3
160	20.5	23.4	24.3	25.2	26.2	27.3	28.6	30.2	32.3	35.7	69.6
170	20.5	23.5	24.4	25.3	26.2	27.3	28.7	30.3	32.4	35.8	69.6
180	20.5	23.5	24.4	25.3	26.3	27.4	28.7	30.3	32.5	35.9	69.8
190	20.6	23.6	24.5	25.3	26.3	27.5	28.8	30.4	32.5	36.0	69.8
200	20.6	23.6	24.5	25.4	26.4	27.5	28.9	30.4	32.6	36.0	70.1
210	20.6	23.7	24.6	25.4	26.4	27.5	28.9	30.5	32.7	36.1	70.1
220	20.7	23.7	24.6	25.5	26.5	27.6	28.9	30.5	32.7	36.2	70.1
230	20.7	23.7	24.6	25.5	26.5	27.6	29.0	30.6	32.7	36.2	70.3
240	20.7	23.8	24.7	25.5	26.5	27.6	29.0	30.6	32.8	36.3	70.3
250	20.7	23.8	24.7	25.6	26.5	27.7	29.1	30.6	32.8	36.3	70.3

Class 05-02

Max Moment	WPV		
	Span (FT)	Moment	Percentile of H5P
20	415.5	100.00%	100.00%
30	720.3	100.00%	100.00%
40	1043.0	100.00%	100.00%
50	1380.7	100.00%	100.00%
60	1729.9	100.00%	100.00%
70	2081.3	100.00%	100.00%
80	2586.4	100.00%	100.00%
90	3172.1	100.00%	100.00%
100	3845.2	100.00%	100.00%
110	4506.6	100.00%	100.00%
120	5164.3	100.00%	100.00%
130	5835.8	100.00%	100.00%
140	6492.5	100.00%	100.00%
150	7166.9	100.00%	100.00%
160	7844.0	100.00%	100.00%
170	8464.9	100.00%	100.00%
180	9167.9	100.00%	100.00%
190	9788.0	100.00%	100.00%
200	10467.5	100.00%	100.00%
210	11157.8	100.00%	100.00%
220	11823.2	100.00%	100.00%
230	12519.1	100.00%	100.00%
240	13184.3	100.00%	100.00%
250	13859.5	100.00%	100.00%

Class 05-02

Max Shear	WPV		
Span	Shear	Percentile of H5P	Percentile of Total
20	84.0	100.00%	100.00%
30	98.9	100.00%	100.00%
40	106.3	100.00%	100.00%
50	114.0	100.00%	100.00%
60	133.2	100.00%	100.00%
70	149.0	100.00%	100.00%
80	161.4	100.00%	100.00%
90	169.6	100.00%	100.00%
100	178.8	100.00%	100.00%
110	184.8	100.00%	100.00%
120	190.5	100.00%	100.00%
130	195.6	100.00%	100.00%
140	200.3	100.00%	100.00%
150	203.2	100.00%	100.00%
160	205.1	100.00%	100.00%
170	207.3	100.00%	100.00%
180	209.2	100.00%	100.00%
190	211.4	100.00%	100.00%
200	214.3	100.00%	100.00%
210	217.4	100.00%	100.00%
220	217.7	100.00%	100.00%
230	218.7	100.00%	100.00%
240	219.7	100.00%	100.00%
250	220.6	100.00%	100.00%

Class 05-02

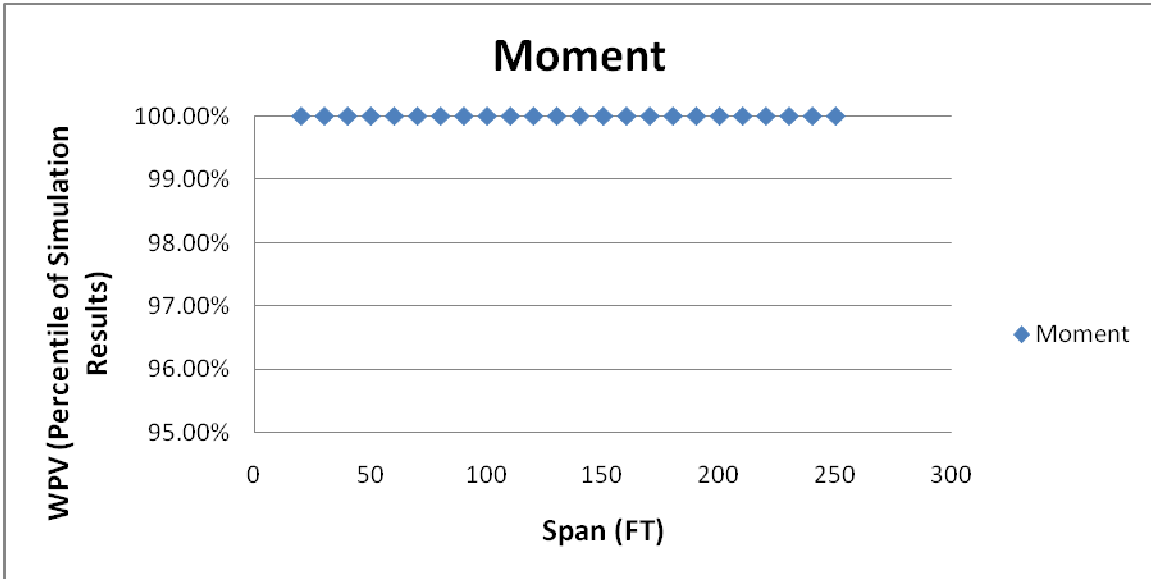

Class 05-02

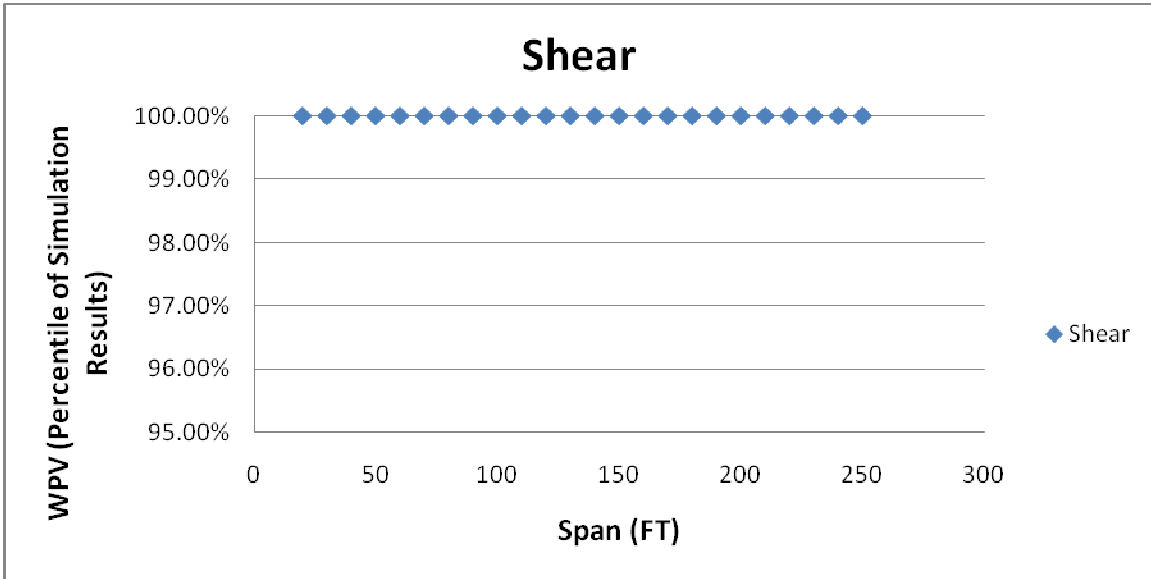

Class 06-03

	Forecast Percentile										
	0%	10%	20%	30%	40%	50%	60%	70%	80%	90%	100%
Total Length of Truck	9.34	17.23	18.96	20.11	20.96	21.87	22.60	23.41	24.30	25.50	35.27
Total Weight of Truck	52.07	54.07	55.25	56.69	58.33	60.15	62.38	65.58	69.86	77.79	127.49
FHWA Bridge Formula	43.00	48.92	50.22	51.08	51.72	52.40	52.95	53.56	54.22	55.13	62.45
Ratio FHWA WT/WT	0.38	0.68	0.74	0.79	0.83	0.86	0.89	0.92	0.95	0.98	1.13

Class 06-03

Max Moment Span (FT)	Forecast Percentile (K-FT)										
	0%	10%	20%	30%	40%	50%	60%	70%	80%	90%	100%
20	103.3	156.8	168.2	176.8	184.8	193.0	202.5	213.0	227.4	251.1	569.3
30	200.0	255.5	274.6	288.7	300.9	314.4	328.3	345.5	367.7	404.4	871.6
40	279.3	367.2	392.9	411.7	429.3	447.5	467.0	490.6	521.2	573.7	1177.8
50	395.3	504.9	534.5	559.0	578.9	602.6	627.1	658.2	699.8	770.2	1500.1
60	529.3	654.7	686.9	713.0	737.0	764.0	793.2	832.5	885.1	975.8	1841.0
70	673.2	804.1	839.0	867.6	895.2	925.3	962.2	1009.0	1070.5	1182.7	2175.8
80	815.9	953.2	990.7	1022.1	1053.6	1088.1	1131.3	1186.3	1258.5	1389.2	2506.1
90	963.3	1101.9	1141.6	1175.8	1210.7	1252.1	1301.6	1363.9	1447.9	1599.0	2844.5
100	1106.2	1251.2	1293.8	1330.9	1369.9	1416.1	1470.6	1542.6	1637.7	1810.9	3188.5
110	1248.8	1399.4	1446.3	1485.4	1529.2	1579.7	1641.1	1719.1	1825.6	2022.6	3520.6
120	1397.2	1549.8	1596.5	1640.0	1687.6	1743.5	1810.5	1896.1	2015.8	2231.5	3867.0
130	1541.4	1697.7	1750.2	1795.6	1847.6	1909.3	1982.4	2076.0	2205.2	2448.0	4197.1
140	1680.3	1848.3	1901.6	1949.6	2007.2	2072.7	2153.2	2253.7	2396.3	2655.2	4528.4
150	1822.2	1997.9	2052.2	2105.9	2165.0	2236.8	2323.7	2434.8	2588.5	2867.1	4863.0
160	1966.9	2148.0	2204.5	2261.6	2325.9	2401.7	2495.4	2612.7	2780.5	3079.3	5255.4
170	2114.5	2297.3	2357.8	2418.4	2487.2	2567.7	2668.2	2794.5	2973.5	3299.7	5541.9
180	2265.0	2445.2	2507.2	2571.8	2643.4	2729.4	2837.4	2972.3	3164.6	3509.2	5944.7
190	2393.5	2594.3	2659.1	2726.9	2804.1	2895.4	3009.7	3153.7	3359.2	3721.3	6228.1
200	2545.2	2744.6	2812.8	2884.2	2963.8	3062.3	3180.3	3330.2	3550.9	3936.4	6641.1
210	2687.5	2891.4	2961.9	3037.9	3123.2	3225.1	3350.4	3510.9	3741.8	4145.7	6973.2
220	2828.0	3042.9	3113.6	3195.4	3282.8	3389.9	3522.4	3690.3	3936.0	4362.0	7305.3
230	2976.8	3190.5	3264.9	3352.5	3445.5	3557.0	3694.1	3871.9	4128.0	4571.9	7678.7
240	3128.5	3339.5	3417.2	3505.3	3602.1	3720.0	3860.7	4050.3	4316.9	4784.4	8012.5
250	3272.0	3488.6	3568.6	3661.0	3761.6	3886.6	4038.5	4231.6	4506.3	4994.6	8346.4

Class 06-03

Max Shear	Forecast Percentile (Kips)										
	Span	0%	10%	20%	30%	40%	50%	60%	70%	80%	90%
20	25.3	32.2	34.5	36.3	37.8	39.6	41.4	43.6	46.3	51.0	106.9
30	30.1	37.9	40.1	41.8	43.4	45.1	46.9	49.3	52.3	57.5	110.7
40	34.5	42.3	44.2	45.7	47.1	48.7	50.6	53.2	56.4	62.2	113.6
50	38.4	44.9	46.5	47.9	49.3	51.0	53.0	55.5	59.0	65.2	115.2
60	40.9	46.5	48.0	49.3	50.8	52.5	54.5	57.1	60.6	67.2	116.5
70	42.9	47.7	49.1	50.4	51.8	53.6	55.6	58.2	61.9	68.6	117.3
80	44.3	48.6	49.9	51.2	52.6	54.4	56.4	59.1	62.9	69.6	118.4
90	45.4	49.2	50.5	51.8	53.2	54.9	57.1	59.8	63.7	70.5	119.1
100	46.4	49.7	51.0	52.3	53.7	55.5	57.6	60.3	64.3	71.3	120.2
110	46.9	50.1	51.3	52.7	54.1	55.9	58.0	60.8	64.8	71.8	120.5
120	47.3	50.4	51.6	53.0	54.4	56.2	58.3	61.2	65.2	72.3	120.9
130	47.8	50.7	51.9	53.2	54.7	56.5	58.7	61.5	65.5	72.7	121.2
140	48.0	50.9	52.1	53.5	55.0	56.8	58.9	61.8	65.8	73.0	122.0
150	48.4	51.2	52.3	53.7	55.2	57.0	59.1	62.0	66.1	73.3	122.4
160	48.7	51.3	52.5	53.9	55.4	57.2	59.3	62.3	66.3	73.5	123.2
170	49.0	51.5	52.7	54.0	55.6	57.4	59.5	62.4	66.6	73.8	122.7
180	49.2	51.6	52.8	54.1	55.7	57.5	59.7	62.6	66.7	74.0	123.5
190	49.0	51.8	52.9	54.3	55.8	57.6	59.8	62.8	66.9	74.2	123.0
200	49.3	51.9	53.1	54.4	56.0	57.8	59.9	62.9	67.0	74.3	123.8
210	49.5	52.0	53.2	54.5	56.1	57.9	60.0	63.0	67.2	74.5	123.8
220	49.5	52.1	53.3	54.6	56.2	57.9	60.1	63.1	67.3	74.6	123.8
230	49.7	52.1	53.3	54.7	56.3	58.0	60.2	63.2	67.4	74.8	124.2
240	49.7	52.2	53.4	54.7	56.3	58.1	60.3	63.3	67.5	74.9	124.2
250	49.9	52.3	53.5	54.8	56.4	58.2	60.4	63.4	67.6	75.0	124.2

Class 06-03

Max Moment	WPV		
Span (FT)	Moment	Percentile of H5P	Percentile of Total
20	415.5	99.37%	99.97%
30	720.3	99.57%	99.98%
40	1043.0	99.69%	99.98%
50	1380.7	99.77%	99.99%
60	1729.9	99.82%	99.99%
70	2081.3	99.86%	99.99%
80	2586.4	100.00%	100.00%
90	3172.1	100.00%	100.00%
100	3845.2	100.00%	100.00%
110	4506.6	100.00%	100.00%
120	5164.3	100.00%	100.00%
130	5835.8	100.00%	100.00%
140	6492.5	100.00%	100.00%
150	7166.9	100.00%	100.00%
160	7844.0	100.00%	100.00%
170	8464.9	100.00%	100.00%
180	9167.9	100.00%	100.00%
190	9788.0	100.00%	100.00%
200	10467.5	100.00%	100.00%
210	11157.8	100.00%	100.00%
220	11823.2	100.00%	100.00%
230	12519.1	100.00%	100.00%
240	13184.3	100.00%	100.00%
250	13859.5	100.00%	100.00%

Class 06-03

Max Shear	WPV		
Span	Shear	Percentile of H5P	Percentile of Total
20	84.0	99.45%	99.97%
30	98.9	99.68%	99.98%
40	106.3	99.79%	99.99%
50	114.0	99.96%	100.00%
60	133.2	100.00%	100.00%
70	149.0	100.00%	100.00%
80	161.4	100.00%	100.00%
90	169.6	100.00%	100.00%
100	178.8	100.00%	100.00%
110	184.8	100.00%	100.00%
120	190.5	100.00%	100.00%
130	195.6	100.00%	100.00%
140	200.3	100.00%	100.00%
150	203.2	100.00%	100.00%
160	205.1	100.00%	100.00%
170	207.3	100.00%	100.00%
180	209.2	100.00%	100.00%
190	211.4	100.00%	100.00%
200	214.3	100.00%	100.00%
210	217.4	100.00%	100.00%
220	217.7	100.00%	100.00%
230	218.7	100.00%	100.00%
240	219.7	100.00%	100.00%
250	220.6	100.00%	100.00%

Class 06-03

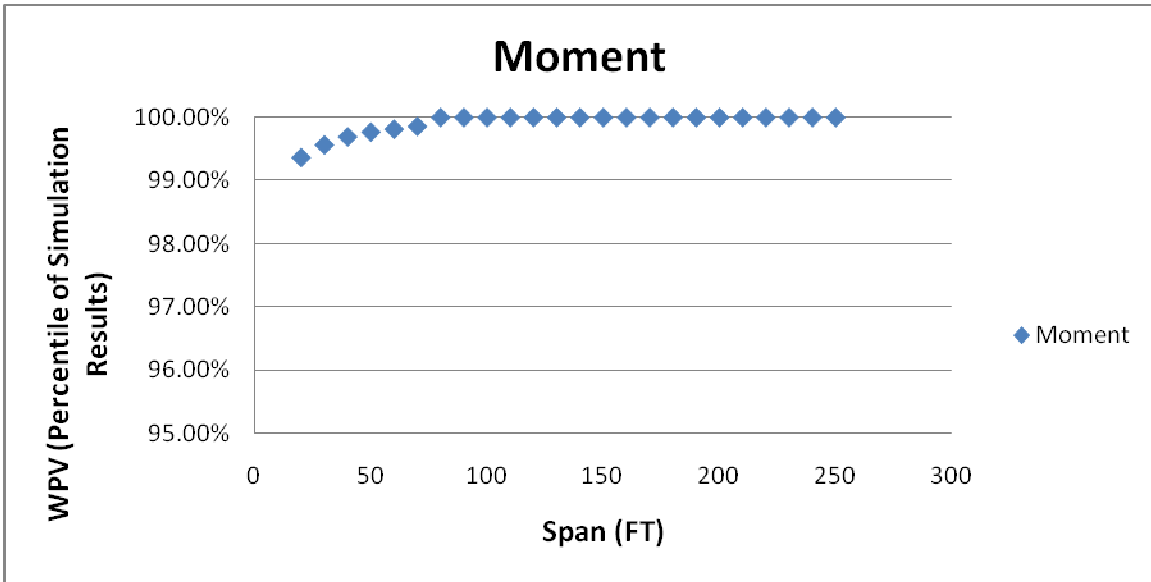

Class 06-03

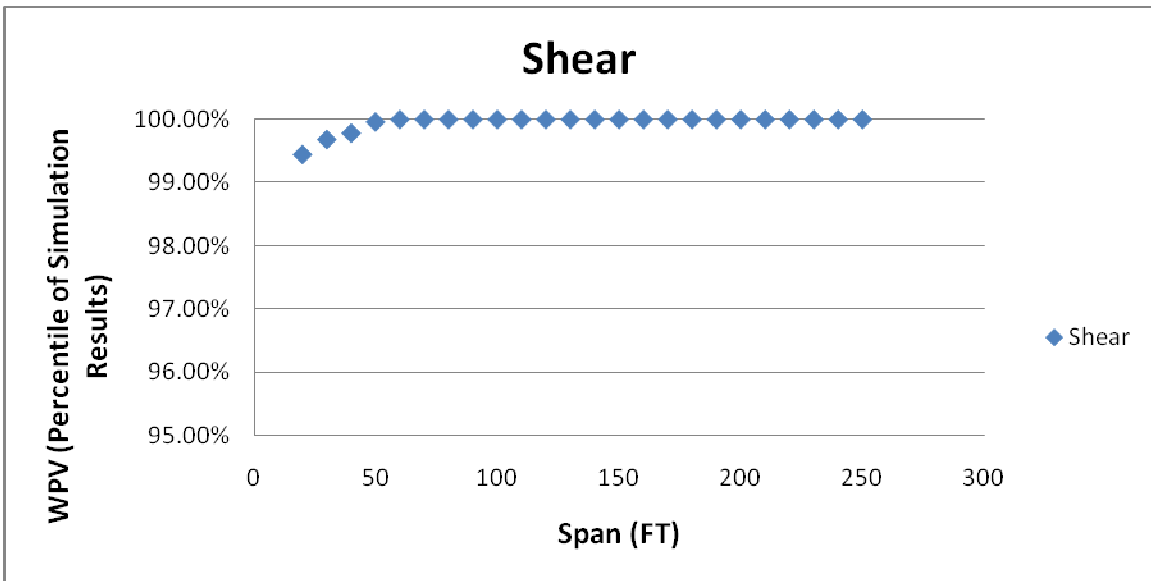

Class 07-04

	Forecast Percentile										
	0%	10%	20%	30%	40%	50%	60%	70%	80%	90%	100%
Total Length of Truck	15.77	18.73	19.90	21.11	22.19	22.94	23.72	24.73	26.01	27.40	47.11
Total Weight of Truck	75.85	80.86	82.02	83.42	85.04	87.04	89.02	91.60	95.61	103.17	183.63
FHWA Bridge Formula	52.51	54.49	55.26	56.08	56.80	57.29	57.81	58.48	59.34	60.27	73.41
Ratio FHWA WT/WT	0.32	0.55	0.60	0.62	0.64	0.66	0.67	0.68	0.70	0.72	0.83

Class 07-04

Max Moment	Forecast Percentile (K-FT)										
	0%	10%	20%	30%	40%	50%	60%	70%	80%	90%	100%
Span (FT)											
20	175.7	215.7	227.5	236.8	246.3	254.8	263.9	275.5	289.2	309.2	555.2
30	319.8	373.1	391.2	405.5	419.4	432.6	448.7	466.7	486.1	519.8	938.7
40	454.2	555.2	580.7	600.1	617.9	635.9	653.9	679.7	708.5	760.8	1332.5
50	603.7	765.7	796.0	819.0	842.6	865.1	887.5	916.9	955.9	1025.1	1810.5
60	822.1	987.4	1019.6	1044.3	1072.5	1097.4	1125.8	1160.6	1209.4	1300.0	2316.2
70	1037.4	1206.5	1242.3	1270.7	1301.7	1330.8	1363.7	1405.2	1465.6	1579.7	2807.6
80	1262.6	1428.1	1464.5	1496.7	1530.1	1565.5	1603.1	1651.1	1721.9	1857.1	3305.1
90	1471.8	1646.7	1688.4	1722.8	1760.7	1800.0	1842.3	1896.3	1978.9	2132.2	3790.2
100	1693.8	1867.3	1909.5	1948.5	1991.7	2033.9	2080.7	2141.2	2236.0	2411.6	4291.3
110	1904.7	2087.4	2131.9	2174.4	2223.3	2268.9	2322.5	2390.6	2496.6	2688.3	4765.6
120	2127.2	2305.2	2355.7	2399.9	2453.8	2505.0	2563.3	2637.7	2756.2	2969.0	5258.8
130	2345.4	2525.9	2577.6	2625.9	2685.1	2740.2	2804.0	2883.7	3011.3	3250.1	5765.1
140	2541.8	2745.9	2801.3	2853.7	2916.2	2977.9	3045.8	3132.5	3273.5	3531.7	6247.2
150	2762.7	2966.0	3024.9	3079.8	3147.7	3216.4	3288.2	3381.7	3536.7	3808.6	6724.2
160	2978.9	3185.3	3249.4	3307.1	3379.9	3451.0	3531.6	3631.5	3796.3	4088.5	7332.0
170	3184.5	3408.5	3472.3	3533.2	3612.7	3688.1	3772.3	3879.6	4054.7	4374.0	7709.8
180	3392.7	3631.0	3700.2	3762.2	3843.3	3929.6	4015.6	4134.2	4319.3	4654.3	8233.3
190	3611.0	3848.6	3918.9	3989.9	4077.4	4165.1	4256.2	4378.7	4578.9	4935.7	8729.7
200	3809.3	4071.9	4145.8	4215.2	4309.1	4403.8	4501.8	4631.2	4837.5	5215.5	9324.9
210	4041.9	4291.3	4370.4	4446.2	4540.6	4642.8	4742.6	4882.4	5104.0	5499.3	9691.7
220	4244.0	4517.9	4594.2	4673.7	4775.7	4878.8	4985.4	5129.7	5363.0	5777.1	10302.6
230	4453.0	4735.7	4819.3	4900.4	5006.6	5114.8	5229.4	5383.3	5625.1	6062.0	10770.9
240	4677.3	4958.8	5043.3	5128.0	5240.3	5356.0	5473.1	5632.9	5889.5	6347.5	11288.5
250	4890.4	5181.0	5269.8	5363.4	5474.2	5594.8	5716.7	5881.8	6148.1	6628.6	11758.9

Class 07-04

Max Shear	Forecast Percentile (Kips)										
	0%	10%	20%	30%	40%	50%	60%	70%	80%	90%	100%
20	39.3	46.6	48.7	50.2	51.9	53.5	55.3	57.5	60.5	64.5	116.4
30	43.9	54.8	57.2	59.1	60.6	62.3	64.0	66.2	69.1	74.3	130.8
40	50.6	61.5	63.7	65.2	66.7	68.3	70.1	72.2	75.3	80.9	144.8
50	56.2	65.6	67.5	68.9	70.4	72.0	73.8	75.9	79.2	85.4	151.4
60	60.3	68.2	70.0	71.3	72.8	74.5	76.2	78.4	81.8	88.2	157.4
70	62.9	70.1	71.7	73.0	74.5	76.2	78.0	80.2	83.7	90.4	161.0
80	65.1	71.5	73.0	74.3	75.9	77.5	79.3	81.5	85.2	92.0	164.7
90	66.7	72.6	74.0	75.3	76.9	78.6	80.4	82.6	86.3	93.1	166.2
100	67.8	73.4	74.8	76.1	77.7	79.4	81.2	83.4	87.3	94.1	167.7
110	69.0	74.1	75.4	76.7	78.4	80.1	81.9	84.2	88.0	94.9	168.5
120	69.9	74.7	76.0	77.2	78.9	80.7	82.5	84.8	88.7	95.6	170.1
130	70.4	75.2	76.4	77.7	79.4	81.2	82.9	85.3	89.2	96.1	171.8
140	71.2	75.6	76.8	78.1	79.8	81.6	83.4	85.8	89.6	96.7	171.7
150	71.7	76.0	77.1	78.5	80.1	81.9	83.7	86.1	89.9	97.1	172.0
160	72.2	76.2	77.4	78.8	80.4	82.2	84.0	86.5	90.3	97.4	174.6
170	72.4	76.5	77.7	79.0	80.7	82.5	84.3	86.8	90.6	97.7	173.7
180	72.6	76.8	78.0	79.2	81.0	82.7	84.6	87.1	90.9	98.1	174.4
190	73.1	77.0	78.1	79.5	81.2	82.9	84.8	87.3	91.1	98.3	174.8
200	73.6	77.2	78.3	79.6	81.4	83.2	85.0	87.5	91.3	98.5	176.1
210	73.4	77.3	78.5	79.8	81.5	83.3	85.2	87.7	91.5	98.8	175.2
220	73.6	77.5	78.7	80.0	81.7	83.5	85.3	87.8	91.7	98.9	176.5
230	73.8	77.6	78.8	80.1	81.8	83.6	85.5	88.1	91.9	99.1	176.5
240	74.0	77.8	78.9	80.2	81.9	83.8	85.6	88.2	92.0	99.2	176.9
250	74.0	77.9	79.0	80.4	82.1	83.9	85.8	88.3	92.2	99.5	176.9

Class 07-04

Max Moment	WPV		
	Span (FT)	Moment	Percentile of H5P
20	415.5	99.21%	99.96%
30	720.3	99.26%	99.96%
40	1043.0	99.27%	99.96%
50	1380.7	99.22%	99.96%
60	1729.9	99.19%	99.96%
70	2081.3	99.17%	99.96%
80	2586.4	99.30%	99.97%
90	3172.1	99.47%	99.97%
100	3845.2	99.67%	99.98%
110	4506.6	99.82%	99.99%
120	5164.3	99.94%	100.00%
130	5835.8	100.00%	100.00%
140	6492.5	100.00%	100.00%
150	7166.9	100.00%	100.00%
160	7844.0	100.00%	100.00%
170	8464.9	100.00%	100.00%
180	9167.9	100.00%	100.00%
190	9788.0	100.00%	100.00%
200	10467.5	100.00%	100.00%
210	11157.8	100.00%	100.00%
220	11823.2	100.00%	100.00%
230	12519.1	100.00%	100.00%
240	13184.3	100.00%	100.00%
250	13859.5	100.00%	100.00%

Class 07-04

Max Shear	WPV		
Span	Shear	Percentile of H5P	Percentile of Total
20	84.0	99.12%	99.96%
30	98.9	99.20%	99.96%
40	106.3	99.16%	99.96%
50	114.0	99.21%	99.96%
60	133.2	99.51%	99.98%
70	149.0	99.76%	99.99%
80	161.4	99.94%	100.00%
90	169.6	100.00%	100.00%
100	178.8	100.00%	100.00%
110	184.8	100.00%	100.00%
120	190.5	100.00%	100.00%
130	195.6	100.00%	100.00%
140	200.3	100.00%	100.00%
150	203.2	100.00%	100.00%
160	205.1	100.00%	100.00%
170	207.3	100.00%	100.00%
180	209.2	100.00%	100.00%
190	211.4	100.00%	100.00%
200	214.3	100.00%	100.00%
210	217.4	100.00%	100.00%
220	217.7	100.00%	100.00%
230	218.7	100.00%	100.00%
240	219.7	100.00%	100.00%
250	220.6	100.00%	100.00%

Class 07-04

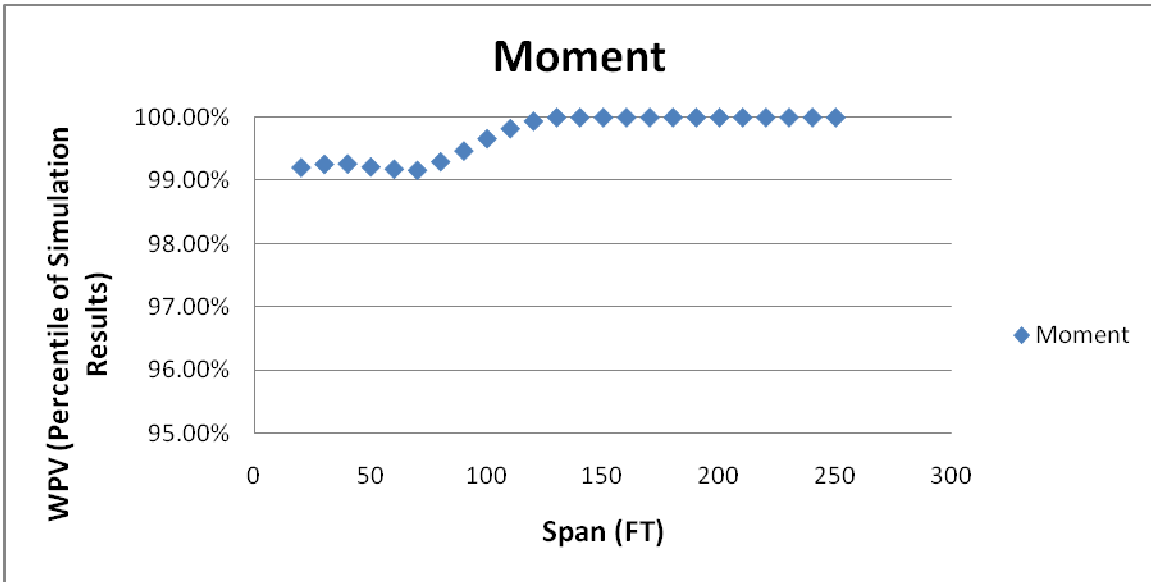

Class 07-04

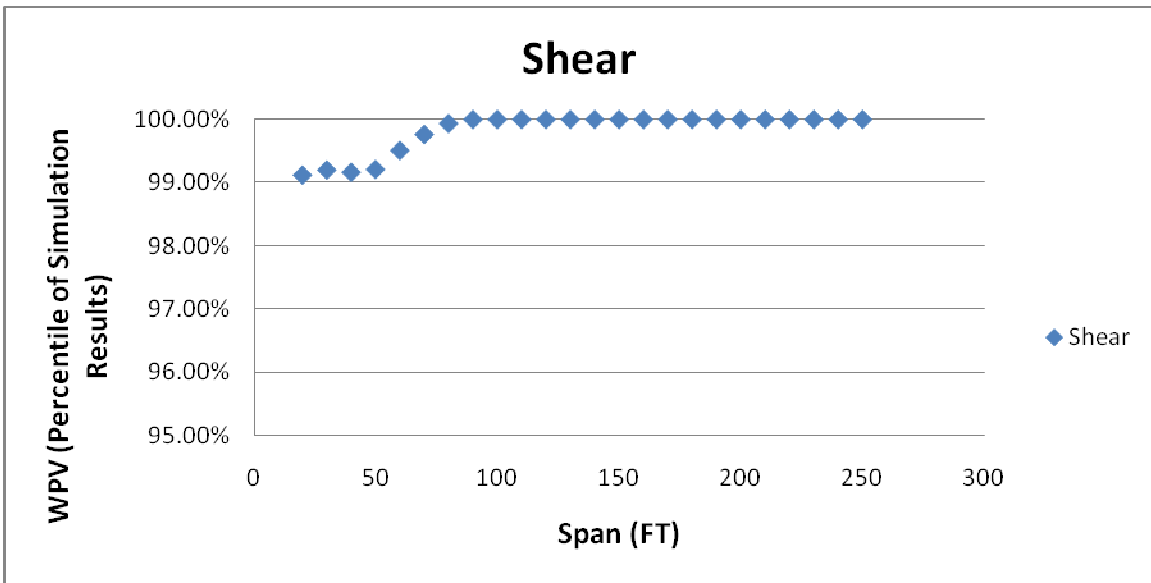

Class 07-05

	Forecast Percentile										
	0%	10%	20%	30%	40%	50%	60%	70%	80%	90%	100%
Total Length of Truck	19.12	20.82	21.35	21.68	22.04	22.61	25.66	26.62	27.19	27.97	34.27
Total Weight of Truck	91.77	94.62	96.08	98.03	100.46	103.36	106.72	112.21	119.21	127.88	173.40
FHWA Bridge Formula	59.95	61.01	61.34	61.55	61.77	62.13	64.04	64.64	65.00	65.48	69.42
Ratio FHWA WT/WT	0.37	0.49	0.53	0.57	0.59	0.61	0.62	0.64	0.65	0.66	0.72

Class 07-05

Max Moment Span (FT)	Forecast Percentile (K-FT)										
	0%	10%	20%	30%	40%	50%	60%	70%	80%	90%	100%
20	188.9	250.6	262.8	274.0	283.7	295.0	306.7	320.4	336.6	358.3	477.1
30	371.7	448.9	467.8	484.5	501.9	518.7	537.7	561.8	593.0	630.0	846.5
40	559.6	671.4	698.7	722.1	743.9	764.6	791.2	826.8	869.7	932.6	1215.9
50	780.2	925.2	955.7	983.1	1008.2	1037.6	1070.4	1117.8	1177.7	1265.7	1619.2
60	1028.9	1182.7	1216.5	1247.4	1277.6	1313.0	1356.6	1419.9	1499.0	1606.1	2064.2
70	1280.1	1439.2	1477.9	1512.8	1547.8	1589.6	1644.7	1720.4	1823.0	1950.7	2536.3
80	1533.7	1696.2	1739.4	1777.5	1818.4	1866.9	1932.3	2022.8	2144.6	2292.9	3012.3
90	1784.8	1953.7	1999.0	2041.6	2088.1	2144.8	2218.8	2323.6	2465.4	2637.5	3469.8
100	2032.4	2210.4	2258.9	2305.3	2358.1	2423.0	2506.8	2623.3	2789.1	2980.6	3948.4
110	2276.7	2466.8	2520.4	2571.9	2630.3	2702.4	2796.0	2925.2	3109.9	3328.0	4400.4
120	2528.5	2724.5	2779.4	2838.8	2900.2	2980.1	3082.9	3230.1	3432.6	3670.2	4908.7
130	2778.7	2981.3	3040.6	3104.0	3174.3	3261.2	3373.1	3530.4	3754.4	4013.3	5344.3
140	3028.0	3237.0	3300.3	3369.1	3447.3	3538.7	3658.8	3835.4	4076.4	4354.2	5828.1
150	3291.7	3494.6	3561.0	3635.8	3718.3	3815.5	3951.1	4141.2	4402.3	4698.5	6306.3
160	3539.6	3751.9	3825.1	3903.4	3993.4	4098.6	4243.5	4448.5	4728.2	5050.8	6805.0
170	3801.5	4008.2	4085.6	4169.7	4268.8	4380.5	4533.1	4745.9	5045.7	5392.9	7265.1
180	4054.5	4267.5	4346.5	4438.1	4537.6	4661.6	4825.2	5051.7	5368.2	5741.9	7686.6
190	4277.0	4525.4	4606.8	4703.0	4812.4	4944.2	5110.0	5362.5	5696.3	6083.1	8158.7
200	4542.3	4781.0	4869.0	4973.0	5083.0	5222.4	5403.7	5655.5	6020.3	6439.4	8651.1
210	4792.7	5041.1	5127.6	5239.8	5360.6	5503.9	5697.3	5973.4	6345.8	6778.3	9097.2
220	5032.5	5300.3	5397.3	5508.1	5635.3	5788.1	5981.2	6266.2	6672.8	7135.4	9561.2
230	5298.4	5552.5	5652.7	5772.8	5905.5	6068.5	6275.8	6580.2	6988.2	7472.7	10036.0
240	5530.4	5815.2	5922.4	6043.8	6184.3	6353.3	6571.2	6884.5	7322.3	7830.9	10597.7
250	5794.3	6077.6	6184.1	6311.2	6456.2	6631.0	6856.7	7190.6	7650.2	8181.0	10959.8

Class 07-05

Max Shear	Forecast Percentile (Kips)										
	Span	0%	10%	20%	30%	40%	50%	60%	70%	80%	90%
20	41.2	53.5	56.0	58.2	60.1	62.2	64.6	67.2	70.7	75.6	97.2
30	53.4	63.9	67.0	69.0	71.1	73.1	75.4	78.4	82.9	89.1	110.6
40	62.2	71.9	74.5	76.4	78.3	80.5	82.8	86.5	91.8	98.7	125.8
50	68.2	76.8	78.9	80.7	82.8	84.8	87.6	91.5	97.3	104.3	135.2
60	72.3	79.9	81.9	83.6	85.6	87.7	90.9	94.7	101.0	107.9	140.9
70	75.6	82.1	83.9	85.6	87.6	89.8	93.1	97.1	103.5	110.8	145.9
80	77.9	83.7	85.5	87.3	89.2	91.5	94.8	99.0	105.5	112.9	149.2
90	79.9	84.9	86.6	88.4	90.4	92.8	96.1	100.4	107.0	114.3	151.9
100	81.1	85.9	87.6	89.4	91.4	93.9	97.1	101.7	108.3	115.7	153.7
110	81.8	86.7	88.3	90.1	92.2	94.6	98.0	102.6	109.3	116.8	155.1
120	82.7	87.3	89.0	90.8	92.9	95.4	98.7	103.4	110.0	117.8	157.4
130	83.8	87.9	89.6	91.3	93.4	95.9	99.2	104.0	110.8	118.4	158.2
140	84.6	88.4	90.0	91.8	93.9	96.4	99.8	104.6	111.3	119.0	158.8
150	85.2	88.8	90.4	92.2	94.4	96.9	100.2	105.1	111.8	119.6	159.9
160	85.4	89.2	90.8	92.6	94.7	97.3	100.6	105.5	112.3	120.2	161.6
170	85.8	89.5	91.1	92.9	95.1	97.7	101.0	105.9	112.6	120.6	162.0
180	86.1	89.8	91.3	93.2	95.4	98.0	101.4	106.2	112.9	121.1	163.0
190	86.7	90.0	91.6	93.4	95.7	98.3	101.5	106.6	113.3	121.2	162.5
200	86.7	90.2	91.8	93.6	95.8	98.5	101.8	106.7	113.5	121.7	162.9
210	87.0	90.5	92.0	93.9	96.1	98.7	102.1	107.1	113.7	121.9	164.1
220	87.1	90.7	92.2	94.1	96.3	99.0	102.2	107.2	114.1	122.3	163.5
230	87.2	90.8	92.3	94.2	96.5	99.1	102.4	107.5	114.2	122.5	164.7
240	87.4	91.0	92.5	94.3	96.6	99.3	102.6	107.6	114.5	122.8	165.7
250	87.7	91.1	92.6	94.5	96.8	99.5	102.8	107.9	114.6	123.0	165.1

Class 07-05

Max Moment	WPV		
Span (FT)	Moment	Percentile of H5P	Percentile of Total
20	415.5	99.03%	99.95%
30	720.3	98.53%	99.93%
40	1043.0	97.95%	99.90%
50	1380.7	97.07%	99.85%
60	1729.9	96.56%	99.83%
70	2081.3	95.98%	99.80%
80	2586.4	98.37%	99.92%
90	3172.1	99.30%	99.97%
100	3845.2	99.79%	99.99%
110	4506.6	100.00%	100.00%
120	5164.3	100.00%	100.00%
130	5835.8	100.00%	100.00%
140	6492.5	100.00%	100.00%
150	7166.9	100.00%	100.00%
160	7844.0	100.00%	100.00%
170	8464.9	100.00%	100.00%
180	9167.9	100.00%	100.00%
190	9788.0	100.00%	100.00%
200	10467.5	100.00%	100.00%
210	11157.8	100.00%	100.00%
220	11823.2	100.00%	100.00%
230	12519.1	100.00%	100.00%
240	13184.3	100.00%	100.00%
250	13859.5	100.00%	100.00%

Class 07-05

Max Shear	WPV		
Span	Shear	Percentile of H5P	Percentile of Total
20	84.0	98.03%	99.90%
30	98.9	97.84%	99.89%
40	106.3	96.60%	99.83%
50	114.0	97.24%	99.86%
60	133.2	99.53%	99.98%
70	149.0	100.00%	100.00%
80	161.4	100.00%	100.00%
90	169.6	100.00%	100.00%
100	178.8	100.00%	100.00%
110	184.8	100.00%	100.00%
120	190.5	100.00%	100.00%
130	195.6	100.00%	100.00%
140	200.3	100.00%	100.00%
150	203.2	100.00%	100.00%
160	205.1	100.00%	100.00%
170	207.3	100.00%	100.00%
180	209.2	100.00%	100.00%
190	211.4	100.00%	100.00%
200	214.3	100.00%	100.00%
210	217.4	100.00%	100.00%
220	217.7	100.00%	100.00%
230	218.7	100.00%	100.00%
240	219.7	100.00%	100.00%
250	220.6	100.00%	100.00%

Class 07-05

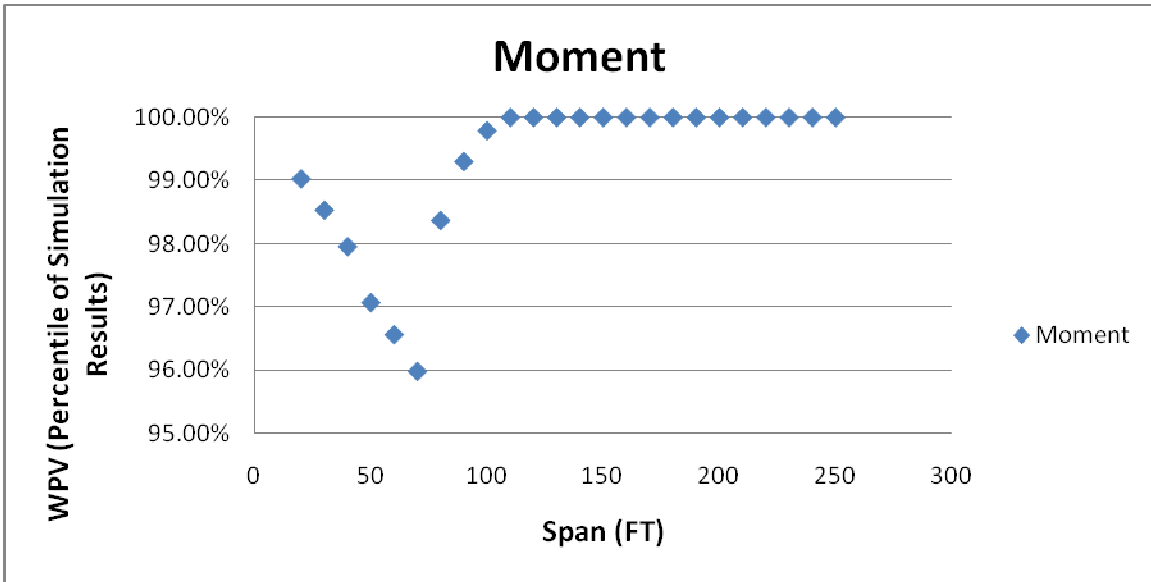

Class 07-05

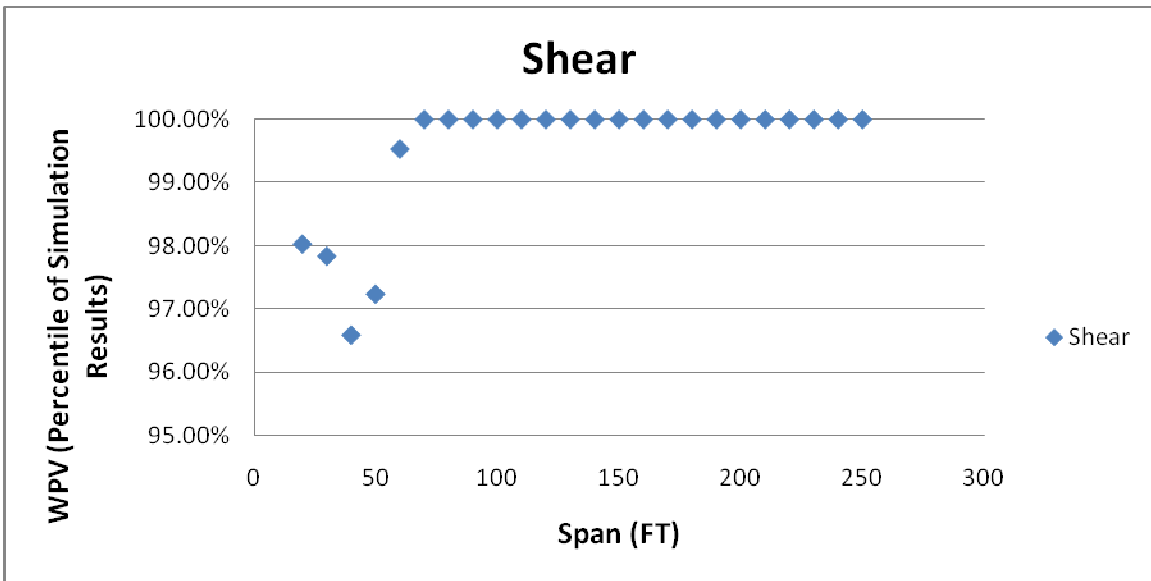

Class 08-03

	Forecast Percentile										
	0%	10%	20%	30%	40%	50%	60%	70%	80%	90%	100%
Total Length of Truck	19.12	31.30	32.86	33.45	33.86	34.39	35.32	37.63	40.50	44.50	57.73
Total Weight of Truck	23.59	26.22	27.46	28.71	30.06	31.65	33.61	35.95	39.38	45.22	99.28
FHWA Bridge Formula	50.34	59.47	60.65	61.08	61.40	61.80	62.49	64.23	66.38	69.37	79.30
Ratio FHWA WT/WT	0.61	1.42	1.61	1.75	1.87	1.98	2.08	2.17	2.27	2.40	3.08

Class 08-03

Max Moment Span (FT)	Forecast Percentile (K-FT)										
	0%	10%	20%	30%	40%	50%	60%	70%	80%	90%	100%
20	46.9	58.0	63.0	67.3	72.3	76.7	82.1	88.6	97.0	110.4	252.8
30	75.0	97.0	105.0	112.0	119.1	126.3	134.9	144.2	157.1	177.9	379.1
40	115.7	146.3	157.9	168.0	177.5	187.4	199.2	212.0	229.9	259.0	548.5
50	147.3	204.4	219.9	232.5	245.4	258.6	273.0	291.2	315.1	352.0	736.1
60	185.5	270.3	289.0	305.7	321.7	338.5	357.0	379.8	409.3	458.3	1003.5
70	231.8	339.9	361.8	381.4	401.0	421.0	444.9	471.5	508.4	569.7	1259.3
80	293.6	410.8	436.7	459.0	482.0	505.7	533.5	567.6	612.9	685.0	1527.0
90	346.3	483.6	512.2	537.7	563.1	590.2	623.1	663.8	717.7	803.4	1782.8
100	425.0	554.8	586.9	615.9	645.4	674.6	713.5	760.3	822.7	921.4	2053.7
110	497.6	626.0	661.3	693.9	725.7	758.6	803.2	856.0	927.3	1043.2	2319.0
120	564.3	697.3	735.6	771.2	808.0	843.9	893.7	952.3	1031.8	1166.0	2574.0
130	634.6	768.2	810.1	848.7	889.3	929.1	984.1	1049.2	1136.0	1289.3	2835.4
140	701.6	838.7	884.4	926.0	970.0	1014.4	1074.5	1145.7	1241.0	1412.0	3103.9
150	763.7	909.5	958.4	1003.8	1051.4	1100.7	1163.9	1242.5	1346.6	1533.5	3353.3
160	830.5	980.7	1033.0	1081.1	1131.5	1185.9	1255.0	1339.0	1453.0	1657.5	3635.8
170	896.0	1051.9	1107.0	1158.6	1212.5	1271.0	1343.7	1435.1	1556.8	1778.1	3893.0
180	963.1	1122.6	1181.6	1236.1	1293.2	1356.2	1435.5	1530.7	1662.8	1901.5	4155.1
190	1035.5	1193.2	1256.2	1313.5	1373.7	1441.7	1525.8	1628.1	1766.7	2021.4	4420.9
200	1099.9	1264.0	1329.7	1391.3	1454.7	1526.4	1616.0	1725.4	1871.5	2141.8	4688.9
210	1161.2	1335.1	1404.1	1467.8	1535.9	1610.9	1707.5	1820.8	1977.4	2258.9	4923.3
220	1227.5	1405.6	1477.4	1545.5	1616.1	1695.0	1794.9	1916.0	2081.3	2383.6	5198.3
230	1290.2	1475.5	1552.4	1622.9	1698.0	1782.1	1887.0	2014.2	2188.4	2504.6	5476.9
240	1358.2	1547.0	1626.7	1700.0	1779.4	1867.7	1978.6	2110.9	2295.3	2625.7	5715.1
250	1427.2	1618.4	1700.8	1777.8	1859.7	1951.1	2067.2	2206.4	2398.1	2749.8	5997.3

Class 08-03

Max Shear	Forecast Percentile (Kips)										
	0%	10%	20%	30%	40%	50%	60%	70%	80%	90%	100%
20	10.5	13.2	14.2	15.1	15.9	16.8	17.8	19.0	20.6	23.3	49.4
30	11.2	15.0	16.1	17.0	17.8	18.8	19.9	21.1	22.9	25.7	54.6
40	12.5	16.6	17.6	18.5	19.3	20.3	21.3	22.7	24.6	27.6	63.3
50	13.7	18.2	19.3	20.1	21.1	22.1	23.2	24.7	26.6	29.9	70.0
60	14.0	19.5	20.6	21.5	22.5	23.5	24.8	26.4	28.4	32.1	74.7
70	15.5	20.5	21.6	22.5	23.5	24.6	26.0	27.7	29.9	33.9	78.1
80	16.6	21.2	22.3	23.3	24.3	25.4	26.9	28.7	31.1	35.3	80.5
90	17.5	21.8	22.9	23.9	25.0	26.1	27.7	29.4	31.9	36.4	82.4
100	18.2	22.2	23.3	24.4	25.5	26.7	28.2	30.0	32.6	37.3	84.1
110	18.8	22.6	23.7	24.7	25.9	27.1	28.7	30.6	33.2	38.0	85.5
120	19.3	22.9	24.0	25.1	26.2	27.5	29.1	31.0	33.7	38.6	86.2
130	19.8	23.1	24.3	25.3	26.5	27.8	29.4	31.3	34.1	39.2	87.2
140	20.2	23.3	24.5	25.6	26.8	28.1	29.7	31.7	34.5	39.6	88.2
150	20.5	23.5	24.7	25.8	26.9	28.3	30.0	32.0	34.8	40.0	88.5
160	20.7	23.7	24.9	25.9	27.1	28.5	30.2	32.2	35.1	40.3	89.2
170	20.9	23.8	25.0	26.1	27.3	28.7	30.4	32.4	35.3	40.6	89.9
180	21.2	24.0	25.2	26.3	27.5	28.9	30.6	32.6	35.5	40.9	90.2
190	21.4	24.1	25.3	26.4	27.6	29.0	30.7	32.8	35.7	41.1	90.6
200	21.6	24.2	25.4	26.5	27.7	29.1	30.8	33.0	35.9	41.3	91.2
210	21.7	24.3	25.5	26.6	27.8	29.3	31.0	33.1	36.1	41.5	91.2
220	21.8	24.4	25.5	26.7	27.9	29.3	31.1	33.2	36.2	41.6	91.6
230	21.8	24.5	25.6	26.8	28.0	29.4	31.2	33.3	36.3	41.8	91.9
240	22.0	24.5	25.7	26.8	28.1	29.5	31.3	33.5	36.5	42.0	91.9
250	22.1	24.6	25.8	26.9	28.2	29.6	31.4	33.5	36.6	42.1	92.6

Class 08-03

Max Moment	WPV		
Span (FT)	Moment	Percentile of H5P	Percentile of Total
20	415.5	100.00%	100.00%
30	720.3	100.00%	100.00%
40	1043.0	100.00%	100.00%
50	1380.7	100.00%	100.00%
60	1729.9	100.00%	100.00%
70	2081.3	100.00%	100.00%
80	2586.4	100.00%	100.00%
90	3172.1	100.00%	100.00%
100	3845.2	100.00%	100.00%
110	4506.6	100.00%	100.00%
120	5164.3	100.00%	100.00%
130	5835.8	100.00%	100.00%
140	6492.5	100.00%	100.00%
150	7166.9	100.00%	100.00%
160	7844.0	100.00%	100.00%
170	8464.9	100.00%	100.00%
180	9167.9	100.00%	100.00%
190	9788.0	100.00%	100.00%
200	10467.5	100.00%	100.00%
210	11157.8	100.00%	100.00%
220	11823.2	100.00%	100.00%
230	12519.1	100.00%	100.00%
240	13184.3	100.00%	100.00%
250	13859.5	100.00%	100.00%

Class 08-03

Max Shear	WPV		
Span	Shear	Percentile of H5P	Percentile of Total
20	84.0	100.00%	100.00%
30	98.9	100.00%	100.00%
40	106.3	100.00%	100.00%
50	114.0	100.00%	100.00%
60	133.2	100.00%	100.00%
70	149.0	100.00%	100.00%
80	161.4	100.00%	100.00%
90	169.6	100.00%	100.00%
100	178.8	100.00%	100.00%
110	184.8	100.00%	100.00%
120	190.5	100.00%	100.00%
130	195.6	100.00%	100.00%
140	200.3	100.00%	100.00%
150	203.2	100.00%	100.00%
160	205.1	100.00%	100.00%
170	207.3	100.00%	100.00%
180	209.2	100.00%	100.00%
190	211.4	100.00%	100.00%
200	214.3	100.00%	100.00%
210	217.4	100.00%	100.00%
220	217.7	100.00%	100.00%
230	218.7	100.00%	100.00%
240	219.7	100.00%	100.00%
250	220.6	100.00%	100.00%

Class 08-03

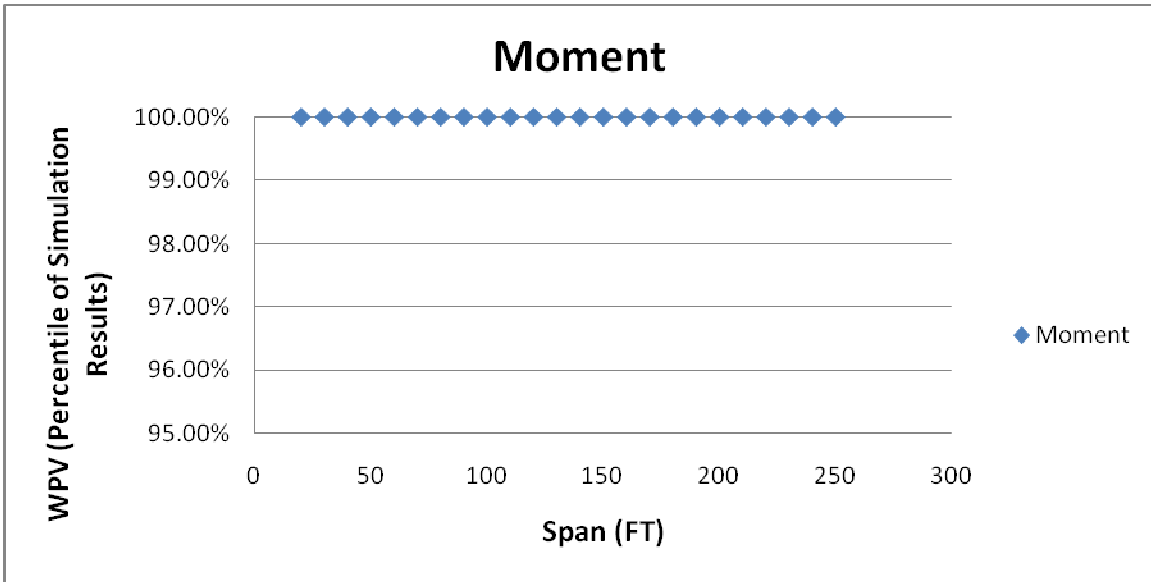

Class 08-03

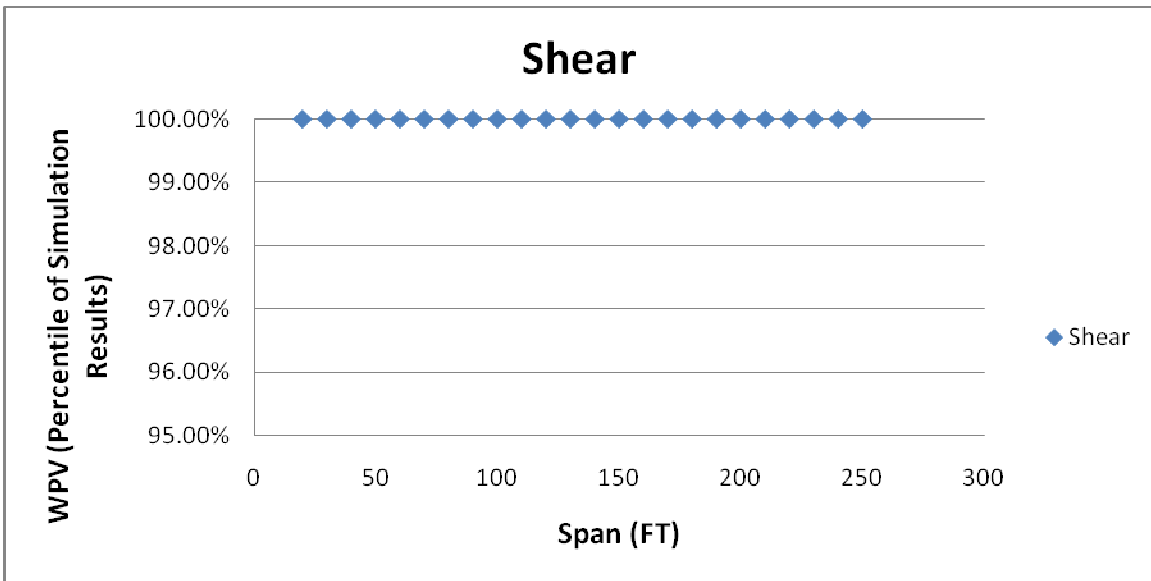

Class 08-04

	Forecast Percentile										
	0%	10%	20%	30%	40%	50%	60%	70%	80%	90%	100%
Total Length of Truck	12.70	44.81	47.92	49.68	51.23	52.59	53.92	55.20	56.84	59.18	129.01
Total Weight of Truck	61.46	68.06	69.74	71.47	73.40	75.50	78.35	81.89	86.94	95.98	154.15
FHWA Bridge Formula	50.46	71.87	73.94	75.12	76.15	77.06	77.95	78.80	79.89	81.45	128.01
Ratio FHWA WT/WT	0.48	0.78	0.87	0.93	0.97	1.01	1.04	1.07	1.11	1.14	1.37

Class 08-04

Max Moment Span (FT)	Forecast Percentile (K-FT)										
	0%	10%	20%	30%	40%	50%	60%	70%	80%	90%	100%
20	61.6	137.5	149.3	158.2	166.3	174.5	183.1	193.4	206.2	225.7	405.3
30	162.5	236.7	253.0	267.6	280.1	292.3	306.4	322.6	344.3	376.9	647.2
40	254.4	342.0	363.7	383.3	401.1	418.9	437.5	460.7	490.8	536.2	900.8
50	364.6	461.3	493.7	516.6	539.0	560.8	584.9	615.5	654.3	715.5	1219.5
60	441.2	584.3	622.8	653.0	680.5	708.9	739.6	775.4	824.7	903.7	1540.1
70	542.0	713.7	766.2	803.0	836.9	872.1	909.7	953.1	1010.6	1115.9	1892.0
80	631.9	866.8	934.2	981.1	1019.2	1062.1	1105.4	1156.1	1222.1	1350.6	2319.1
90	745.0	1042.7	1119.2	1169.6	1212.8	1259.0	1308.6	1367.5	1442.0	1595.7	2738.5
100	862.3	1228.8	1308.1	1362.0	1408.8	1459.9	1516.2	1580.6	1668.6	1841.0	3146.9
110	1026.8	1416.2	1498.5	1554.8	1604.1	1662.7	1724.9	1795.9	1897.4	2086.5	3581.8
120	1200.0	1603.7	1686.4	1748.5	1803.1	1863.9	1935.6	2012.4	2125.1	2335.5	3990.6
130	1367.5	1794.2	1878.1	1943.3	2000.7	2069.2	2145.6	2233.3	2355.0	2585.2	4390.8
140	1531.9	1981.3	2066.4	2136.2	2199.2	2272.2	2356.3	2455.4	2586.8	2833.9	4801.4
150	1672.4	2170.3	2256.8	2327.8	2395.7	2476.3	2564.7	2676.2	2822.5	3088.5	5230.2
160	1783.9	2356.3	2447.0	2520.2	2596.2	2681.1	2777.1	2898.4	3058.6	3334.8	5662.2
170	1937.9	2542.9	2635.8	2712.7	2793.2	2883.8	2988.1	3119.8	3291.2	3591.7	6045.4
180	2140.3	2726.0	2825.1	2903.6	2991.9	3087.0	3197.0	3342.0	3528.7	3843.9	6504.0
190	2330.3	2915.1	3014.6	3096.4	3188.5	3290.2	3405.7	3557.7	3765.3	4106.5	6888.6
200	2502.8	3100.0	3205.4	3290.4	3389.1	3496.4	3619.4	3781.2	4003.9	4363.4	7330.8
210	2665.3	3284.4	3393.1	3481.8	3585.6	3699.5	3829.6	3999.3	4232.9	4625.8	7686.4
220	2862.5	3467.8	3584.7	3675.1	3784.3	3903.0	4042.5	4220.7	4475.1	4881.7	8178.4
230	3074.1	3652.5	3773.0	3866.1	3983.7	4107.0	4253.3	4438.9	4711.7	5141.2	8590.1
240	3236.3	3840.0	3960.6	4059.3	4181.8	4310.7	4461.4	4661.8	4949.8	5399.4	9005.0
250	3415.4	4024.3	4149.6	4252.5	4379.0	4514.6	4674.7	4881.2	5183.3	5661.5	9380.2

Class 08-04

Max Shear	Forecast Percentile (Kips)										
	0%	10%	20%	30%	40%	50%	60%	70%	80%	90%	100%
20	11.7	29.8	31.8	33.4	35.0	36.5	38.2	40.1	42.6	46.5	79.4
30	26.6	34.5	36.7	38.5	40.2	41.8	43.6	45.7	48.4	52.7	91.8
40	28.8	37.3	39.8	41.6	43.3	45.0	46.9	49.1	51.8	56.9	99.4
50	30.5	40.0	42.2	44.0	45.6	47.4	49.3	51.6	54.7	60.1	103.5
60	33.1	42.5	44.6	46.2	47.8	49.6	51.6	54.1	57.4	63.1	106.2
70	34.6	45.1	46.9	48.4	50.0	51.8	53.9	56.4	60.2	65.9	108.2
80	38.3	47.6	49.3	50.8	52.3	54.1	56.3	58.7	62.8	69.2	111.1
90	41.5	49.9	51.5	52.9	54.4	56.2	58.5	61.0	65.3	72.0	115.6
100	43.9	51.7	53.2	54.7	56.3	58.1	60.3	62.9	67.5	74.3	119.3
110	45.8	53.2	54.7	56.2	57.7	59.6	61.8	64.5	69.1	76.2	122.3
120	47.5	54.5	56.0	57.5	59.0	60.9	63.1	65.8	70.7	77.8	125.4
130	48.5	55.5	57.0	58.6	60.1	62.0	64.2	67.1	71.9	79.1	127.3
140	49.5	56.4	57.9	59.5	61.0	62.9	65.2	68.0	73.0	80.3	129.2
150	50.2	57.2	58.7	60.2	61.8	63.7	66.0	68.9	73.9	81.3	130.3
160	51.0	57.9	59.4	60.9	62.5	64.5	66.8	69.6	74.6	82.2	132.2
170	51.7	58.5	60.0	61.5	63.2	65.1	67.4	70.3	75.4	83.0	133.4
180	52.0	59.0	60.6	62.1	63.7	65.6	68.0	70.9	76.0	83.7	134.5
190	52.5	59.5	61.1	62.6	64.2	66.2	68.5	71.4	76.5	84.3	135.6
200	53.0	59.9	61.5	63.0	64.6	66.6	69.0	72.0	77.1	84.9	136.4
210	53.5	60.3	61.9	63.4	65.1	67.1	69.4	72.4	77.5	85.4	137.1
220	53.7	60.6	62.2	63.8	65.4	67.5	69.8	72.8	78.0	85.8	138.2
230	54.2	61.0	62.5	64.1	65.8	67.8	70.2	73.2	78.4	86.3	138.6
240	54.5	61.2	62.8	64.4	66.1	68.1	70.5	73.5	78.7	86.7	139.8
250	54.7	61.5	63.1	64.7	66.4	68.4	70.8	73.9	79.0	87.0	139.8

Class 08-04

Max Moment	WPV		
	Span (FT)	Moment	Percentile of H5P
20	415.5	100.00%	100.00%
30	720.3	100.00%	100.00%
40	1043.0	100.00%	100.00%
50	1380.7	100.00%	100.00%
60	1729.9	100.00%	100.00%
70	2081.3	100.00%	100.00%
80	2586.4	100.00%	100.00%
90	3172.1	100.00%	100.00%
100	3845.2	100.00%	100.00%
110	4506.6	100.00%	100.00%
120	5164.3	100.00%	100.00%
130	5835.8	100.00%	100.00%
140	6492.5	100.00%	100.00%
150	7166.9	100.00%	100.00%
160	7844.0	100.00%	100.00%
170	8464.9	100.00%	100.00%
180	9167.9	100.00%	100.00%
190	9788.0	100.00%	100.00%
200	10467.5	100.00%	100.00%
210	11157.8	100.00%	100.00%
220	11823.2	100.00%	100.00%
230	12519.1	100.00%	100.00%
240	13184.3	100.00%	100.00%
250	13859.5	100.00%	100.00%

Class 08-04

Max Shear	WPV		
Span	Shear	Percentile of H5P	Percentile of Total
20	84.0	100.00%	100.00%
30	98.9	100.00%	100.00%
40	106.3	100.00%	100.00%
50	114.0	100.00%	100.00%
60	133.2	100.00%	100.00%
70	149.0	100.00%	100.00%
80	161.4	100.00%	100.00%
90	169.6	100.00%	100.00%
100	178.8	100.00%	100.00%
110	184.8	100.00%	100.00%
120	190.5	100.00%	100.00%
130	195.6	100.00%	100.00%
140	200.3	100.00%	100.00%
150	203.2	100.00%	100.00%
160	205.1	100.00%	100.00%
170	207.3	100.00%	100.00%
180	209.2	100.00%	100.00%
190	211.4	100.00%	100.00%
200	214.3	100.00%	100.00%
210	217.4	100.00%	100.00%
220	217.7	100.00%	100.00%
230	218.7	100.00%	100.00%
240	219.7	100.00%	100.00%
250	220.6	100.00%	100.00%

Class 08-04

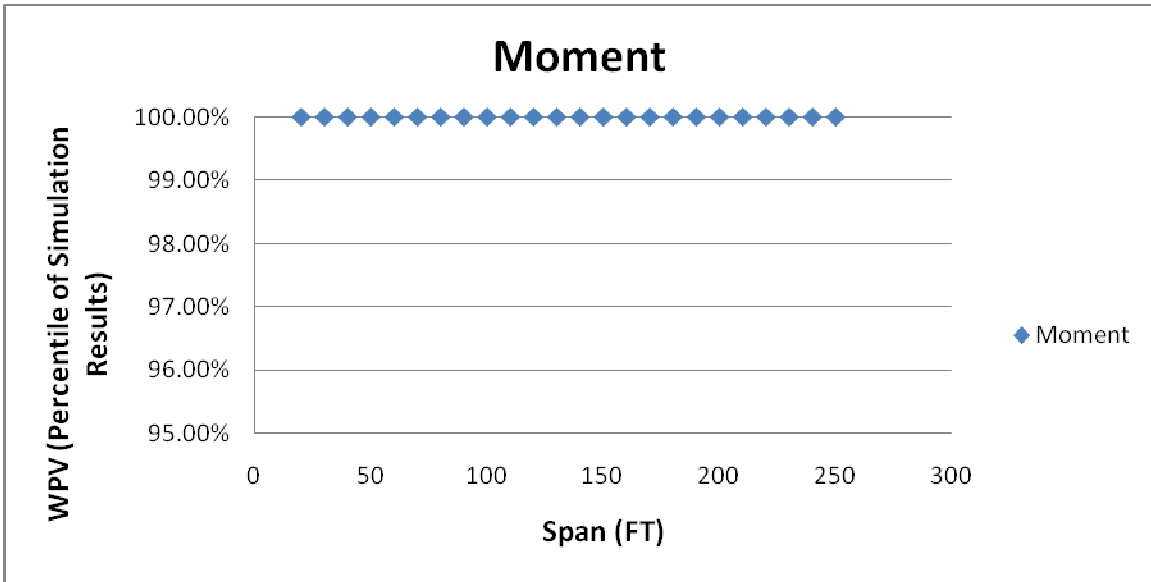

Class 08-04

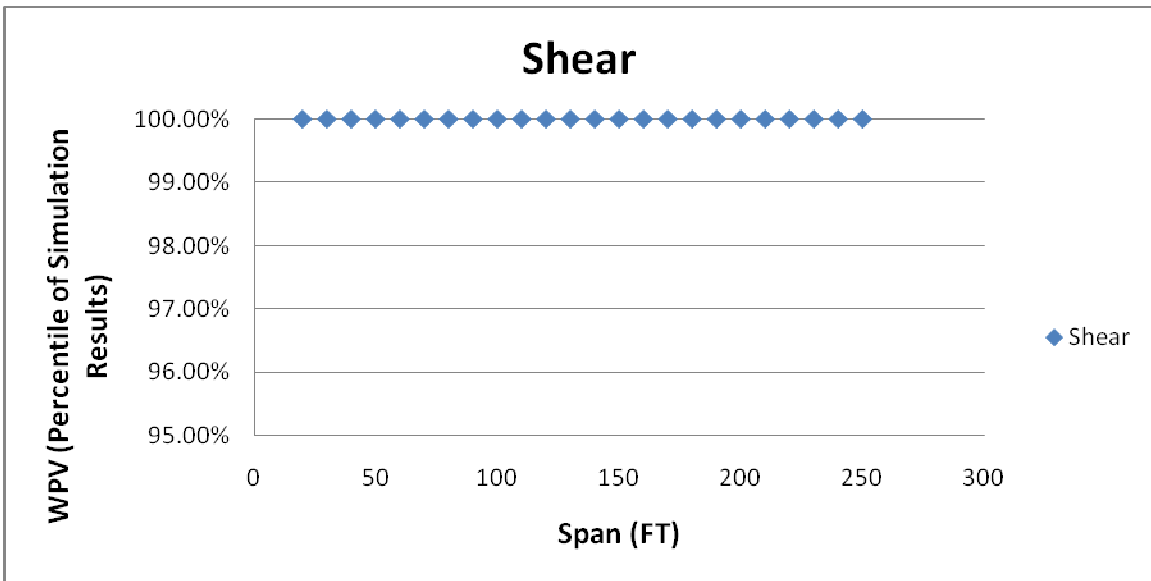

Class 09-05

	Forecast Percentile										
	0%	10%	20%	30%	40%	50%	60%	70%	80%	90%	100%
Total Length of Truck	36.71	54.21	56.28	57.23	57.95	58.64	59.43	60.30	61.47	63.10	83.46
Total Weight of Truck	102.18	107.40	111.56	115.71	120.49	125.20	130.19	135.32	140.89	148.83	215.63
FHWA Bridge Formula	70.95	81.88	83.18	83.77	84.22	84.65	85.14	85.69	86.42	87.44	100.16
Ratio FHWA WT/WT	0.35	0.57	0.60	0.63	0.65	0.68	0.70	0.73	0.76	0.79	0.88

Class 09-05

Max Moment Span (FT)	Forecast Percentile (K-FT)										
	0%	10%	20%	30%	40%	50%	60%	70%	80%	90%	100%
20	133.3	193.6	207.2	217.5	226.8	235.2	244.0	253.8	264.7	279.9	371.2
30	252.8	334.6	352.8	368.4	381.4	395.4	409.8	424.3	441.4	465.6	610.7
40	372.3	473.2	498.5	520.0	539.8	558.9	578.2	599.6	623.4	657.0	960.5
50	525.7	633.6	665.5	694.5	721.8	748.3	774.1	803.1	834.7	882.8	1318.5
60	685.0	799.1	839.3	876.6	910.7	944.5	977.4	1013.5	1054.9	1115.3	1847.5
70	848.0	977.1	1026.1	1074.8	1115.8	1156.0	1196.5	1241.2	1293.9	1364.4	2430.2
80	1003.9	1203.8	1268.0	1324.5	1374.3	1425.7	1477.4	1530.9	1600.7	1692.4	2999.0
90	1220.3	1481.8	1557.0	1623.4	1684.0	1749.7	1812.7	1880.9	1964.3	2076.5	3562.1
100	1471.8	1769.5	1854.1	1931.6	2003.7	2079.4	2156.5	2236.9	2336.6	2465.3	4164.7
110	1748.2	2057.7	2154.3	2241.0	2324.4	2413.1	2503.9	2597.2	2710.2	2857.8	4709.7
120	2026.3	2346.4	2451.7	2549.5	2643.6	2745.8	2849.8	2954.0	3084.0	3255.2	5277.5
130	2300.9	2637.2	2749.7	2857.7	2965.7	3081.0	3195.0	3316.3	3459.2	3650.7	5894.9
140	2587.6	2924.3	3047.4	3163.0	3284.2	3413.1	3540.8	3673.3	3832.4	4044.3	6478.3
150	2869.0	3214.5	3345.1	3473.5	3605.0	3744.6	3889.8	4036.1	4205.9	4444.0	7046.3
160	3139.5	3502.3	3643.5	3784.3	3925.7	4080.3	4238.7	4394.7	4580.0	4841.7	7588.5
170	3409.9	3790.8	3942.1	4089.6	4249.1	4413.0	4585.8	4756.7	4954.0	5239.6	8182.1
180	3695.7	4081.0	4239.6	4397.6	4568.9	4746.7	4932.4	5116.1	5333.0	5634.1	8746.4
190	3960.7	4368.5	4538.5	4710.8	4888.5	5084.0	5283.2	5478.9	5707.2	6030.8	9321.1
200	4244.5	4655.1	4835.5	5012.2	5215.2	5413.3	5627.3	5837.9	6083.8	6422.8	9904.0
210	4534.0	4940.7	5133.7	5320.8	5531.4	5744.9	5972.3	6194.0	6456.5	6816.8	10494.2
220	4806.4	5231.6	5432.3	5631.3	5853.9	6080.0	6319.6	6559.6	6828.6	7218.8	11046.7
230	5081.8	5518.7	5732.0	5938.3	6175.7	6414.2	6669.6	6919.8	7203.6	7615.4	11655.0
240	5333.9	5807.5	6029.6	6246.3	6496.6	6747.1	7013.7	7275.5	7576.8	8004.6	12161.8
250	5618.0	6093.8	6330.0	6556.4	6817.6	7083.4	7363.7	7639.3	7955.4	8403.0	12781.6

Class 09-05

Max Shear	Forecast Percentile (Kips)										
	0%	10%	20%	30%	40%	50%	60%	70%	80%	90%	100%
20	27.8	41.4	43.7	45.6	47.4	49.1	50.9	52.8	54.9	58.0	78.3
30	39.4	47.1	49.6	51.8	53.9	55.8	57.8	60.0	62.3	65.9	95.6
40	43.5	50.9	53.6	56.0	58.1	60.3	62.4	64.8	67.5	71.2	105.8
50	48.2	55.2	57.9	60.1	62.3	64.6	66.7	69.3	72.0	75.9	124.8
60	51.9	60.2	62.9	65.3	67.6	70.2	72.6	75.3	78.5	83.1	138.9
70	55.0	66.0	68.7	71.4	74.0	76.8	79.7	82.7	86.3	91.3	151.1
80	60.3	71.2	73.9	76.7	79.5	82.6	85.8	89.2	92.9	98.2	158.2
90	64.7	75.3	78.1	81.0	84.0	87.3	90.7	94.2	98.3	103.7	164.3
100	69.0	78.5	81.4	84.5	87.6	91.1	94.7	98.2	102.4	108.1	169.6
110	72.0	81.2	84.1	87.2	90.6	94.2	97.9	101.7	106.0	111.7	174.0
120	74.6	83.4	86.4	89.6	93.0	96.7	100.6	104.4	108.8	114.7	176.6
130	76.8	85.3	88.3	91.6	95.1	98.9	102.9	106.8	111.2	117.4	180.1
140	78.5	86.9	90.0	93.3	96.9	100.7	104.8	108.8	113.3	119.5	183.6
150	80.1	88.3	91.4	94.8	98.5	102.3	106.5	110.6	115.1	121.5	185.4
160	82.0	89.5	92.7	96.1	99.8	103.8	108.0	112.1	116.7	123.2	186.7
170	82.7	90.5	93.8	97.2	101.0	105.0	109.3	113.5	118.2	124.7	188.4
180	83.7	91.5	94.8	98.2	102.1	106.1	110.4	114.7	119.4	126.1	189.3
190	84.8	92.4	95.6	99.2	103.1	107.2	111.5	115.8	120.5	127.3	191.9
200	85.9	93.1	96.4	100.0	103.9	108.0	112.3	116.7	121.6	128.3	192.8
210	86.8	93.8	97.1	100.7	104.7	108.9	113.2	117.5	122.4	129.3	194.1
220	87.4	94.4	97.8	101.4	105.4	109.5	114.0	118.4	123.3	130.2	195.0
230	87.9	95.0	98.3	102.0	106.1	110.3	114.7	119.1	124.0	131.0	195.9
240	89.0	95.5	98.9	102.6	106.7	110.8	115.3	119.8	124.6	131.8	195.9
250	89.6	96.0	99.4	103.1	107.2	111.4	115.9	120.4	125.3	132.4	197.2

Class 09-05

Max Moment	WPV		
	Span (FT)	Moment	Percentile of H5P
20	415.5	100.00%	100.00%
30	720.3	100.00%	100.00%
40	1043.0	100.00%	100.00%
50	1380.7	100.00%	100.00%
60	1729.9	99.80%	99.99%
70	2081.3	99.61%	99.98%
80	2586.4	99.62%	99.98%
90	3172.1	99.68%	99.98%
100	3845.2	99.77%	99.99%
110	4506.6	99.86%	99.99%
120	5164.3	99.93%	100.00%
130	5835.8	99.97%	100.00%
140	6492.5	100.00%	100.00%
150	7166.9	100.00%	100.00%
160	7844.0	100.00%	100.00%
170	8464.9	100.00%	100.00%
180	9167.9	100.00%	100.00%
190	9788.0	100.00%	100.00%
200	10467.5	100.00%	100.00%
210	11157.8	100.00%	100.00%
220	11823.2	100.00%	100.00%
230	12519.1	100.00%	100.00%
240	13184.3	100.00%	100.00%
250	13859.5	100.00%	100.00%

Class 09-05

Max Shear	WPV		
Span	Shear	Percentile of H5P	Percentile of Total
20	84.0	100.00%	100.00%
30	98.9	100.00%	100.00%
40	106.3	100.00%	100.00%
50	114.0	99.73%	99.99%
60	133.2	99.87%	99.99%
70	149.0	99.96%	100.00%
80	161.4	100.00%	100.00%
90	169.6	100.00%	100.00%
100	178.8	100.00%	100.00%
110	184.8	100.00%	100.00%
120	190.5	100.00%	100.00%
130	195.6	100.00%	100.00%
140	200.3	100.00%	100.00%
150	203.2	100.00%	100.00%
160	205.1	100.00%	100.00%
170	207.3	100.00%	100.00%
180	209.2	100.00%	100.00%
190	211.4	100.00%	100.00%
200	214.3	100.00%	100.00%
210	217.4	100.00%	100.00%
220	217.7	100.00%	100.00%
230	218.7	100.00%	100.00%
240	219.7	100.00%	100.00%
250	220.6	100.00%	100.00%

Class 09-05

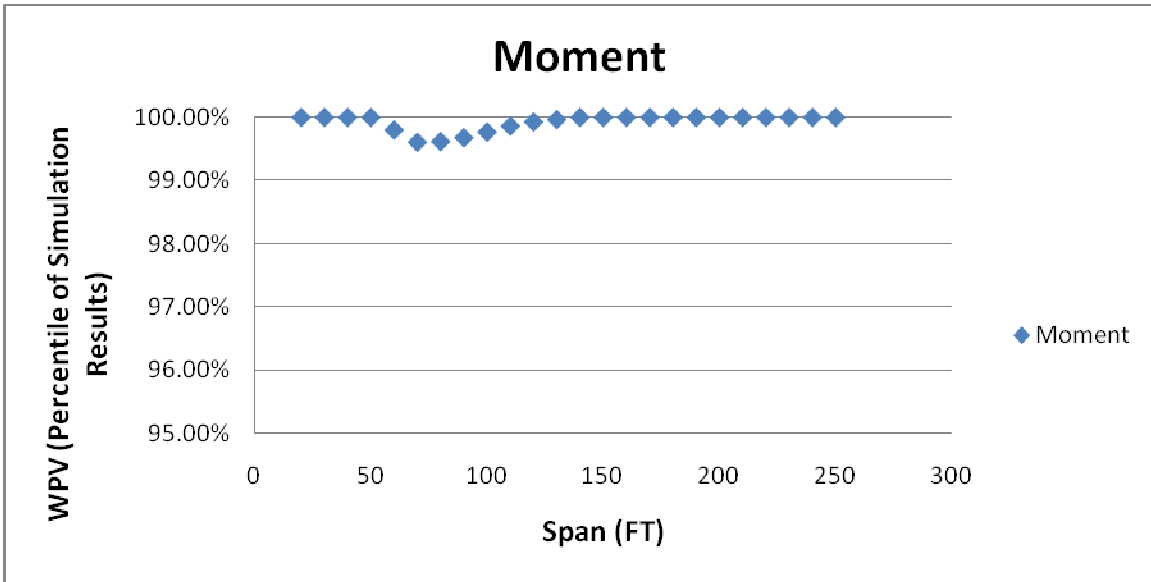

Class 09-05

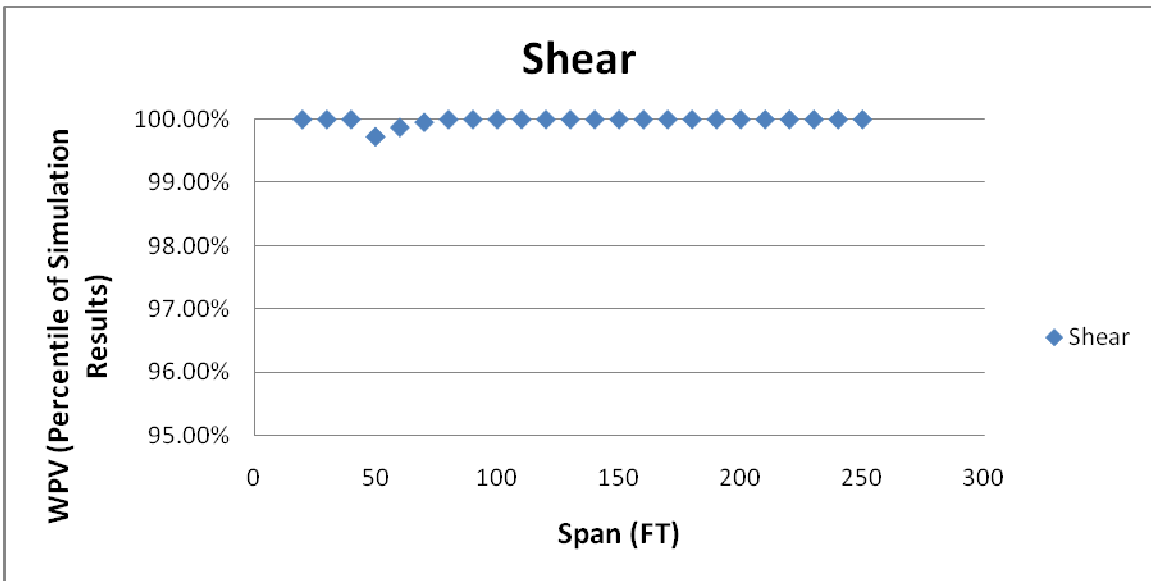

Class 10-06

	Forecast Percentile										
	0%	10%	20%	30%	40%	50%	60%	70%	80%	90%	100%
Total Length of Truck	23.55	39.98	42.22	43.82	44.58	45.37	46.35	47.80	49.40	51.93	460.17
Total Weight of Truck	109.23	116.60	119.41	122.43	125.75	130.19	134.89	141.03	148.48	158.94	237.98
FHWA Bridge Formula	68.13	77.99	79.33	80.29	80.75	81.22	81.81	82.68	83.64	85.16	330.10
Ratio FHWA WT/WT	0.34	0.51	0.55	0.58	0.60	0.63	0.65	0.66	0.68	0.70	1.57

Class 10-06

Max Moment Span (FT)	Forecast Percentile (K-FT)										
	0%	10%	20%	30%	40%	50%	60%	70%	80%	90%	100%
20	143.1	218.6	232.7	243.0	252.6	262.1	272.6	284.1	298.6	321.9	494.3
30	288.6	369.2	391.0	408.0	424.3	439.6	457.4	477.2	501.5	539.7	809.6
40	414.5	534.8	564.8	589.9	612.4	635.7	660.5	687.7	720.9	778.0	1151.8
50	591.6	760.6	808.2	845.4	874.6	909.6	944.2	984.5	1026.9	1102.5	1647.1
60	823.3	1040.6	1097.9	1141.6	1179.0	1222.5	1264.6	1315.1	1374.2	1468.3	2204.9
70	1047.5	1335.9	1403.0	1451.4	1493.9	1548.1	1601.1	1660.3	1740.2	1849.5	2786.0
80	1282.6	1642.5	1717.7	1769.5	1826.4	1886.5	1950.7	2023.6	2123.7	2261.5	3378.1
90	1479.6	1957.3	2038.3	2095.6	2164.7	2233.1	2310.2	2394.6	2514.9	2677.8	4014.8
100	1680.2	2275.6	2359.2	2422.2	2502.1	2580.7	2668.4	2768.5	2906.9	3100.1	4664.3
110	1879.5	2592.2	2680.3	2749.4	2837.2	2930.9	3028.1	3146.4	3302.3	3522.8	5298.9
120	2072.7	2909.4	3000.9	3079.2	3174.8	3278.3	3391.6	3524.5	3699.3	3950.6	5929.4
130	2276.0	3225.9	3320.8	3406.8	3508.9	3625.2	3749.9	3900.1	4094.5	4375.0	6565.3
140	2539.0	3539.8	3643.9	3736.2	3845.2	3975.0	4110.8	4280.0	4495.1	4801.2	7255.4
150	2786.4	3856.6	3962.2	4063.5	4184.5	4322.5	4477.7	4656.0	4893.3	5230.8	7901.3
160	2998.9	4170.9	4286.1	4394.4	4523.7	4670.7	4838.1	5035.0	5294.5	5657.5	8518.4
170	3292.1	4487.5	4606.9	4723.7	4862.5	5023.1	5202.1	5415.1	5684.9	6076.8	9150.8
180	3614.5	4803.2	4929.1	5049.0	5199.4	5373.6	5567.3	5790.0	6090.3	6503.6	9809.0
190	3993.3	5119.2	5250.8	5383.9	5535.9	5721.9	5931.3	6167.1	6491.5	6937.6	10423.4
200	4323.7	5439.3	5572.5	5713.9	5872.6	6070.3	6295.0	6542.7	6889.2	7372.3	11095.3
210	4631.3	5750.8	5899.0	6046.3	6211.5	6419.5	6657.9	6921.0	7291.7	7802.3	11729.7
220	5015.3	6068.6	6219.3	6374.7	6552.4	6767.9	7024.0	7299.2	7687.4	8223.7	12423.6
230	5292.7	6382.8	6544.8	6706.4	6889.4	7126.1	7388.7	7679.9	8095.9	8653.1	13053.5
240	5580.4	6697.0	6864.8	7039.2	7235.4	7478.5	7758.1	8072.9	8494.9	9082.7	13702.1
250	5812.9	7021.0	7190.6	7374.3	7574.3	7825.0	8121.8	8442.8	8892.4	9532.9	14396.7

Class 10-06

Max Shear	Forecast Percentile (Kips)										
	0%	10%	20%	30%	40%	50%	60%	70%	80%	90%	100%
20	35.0	45.2	48.1	50.1	52.2	54.1	56.2	58.8	61.6	66.0	102.0
30	42.8	52.9	56.5	59.0	61.5	63.8	66.4	69.2	72.7	78.3	117.3
40	50.2	63.5	67.9	70.7	73.4	76.0	78.8	82.2	85.9	91.9	142.1
50	55.3	71.5	76.3	79.2	82.0	84.8	87.9	91.6	95.7	102.3	157.8
60	58.3	78.5	83.1	86.2	89.0	92.0	95.2	99.0	103.9	111.0	171.1
70	60.4	84.0	88.4	91.3	94.0	97.2	100.6	104.7	110.0	117.4	180.8
80	61.9	88.4	92.4	95.2	97.9	101.1	104.6	108.9	114.5	122.4	188.8
90	64.9	91.7	95.4	98.1	100.9	104.2	107.9	112.3	118.2	126.3	193.3
100	66.7	94.4	97.9	100.4	103.4	106.6	110.4	114.9	121.0	129.4	198.5
110	70.3	96.5	99.9	102.3	105.3	108.7	112.5	117.1	123.4	132.2	201.4
120	75.0	98.4	101.6	104.0	107.0	110.4	114.4	119.0	125.5	134.2	203.8
130	77.3	99.9	102.9	105.3	108.4	111.8	115.9	120.6	127.2	136.3	206.9
140	80.3	101.1	104.1	106.5	109.6	113.2	117.4	122.1	128.6	138.0	209.7
150	82.3	102.2	105.1	107.5	110.7	114.3	118.6	123.3	130.0	139.4	211.3
160	85.0	103.2	106.1	108.5	111.5	115.2	119.5	124.4	131.1	140.6	213.8
170	86.6	104.0	106.8	109.3	112.3	116.1	120.4	125.4	132.2	141.7	214.4
180	88.4	104.7	107.5	110.0	113.1	116.8	121.3	126.3	133.1	142.6	216.1
190	90.2	105.3	108.1	110.7	113.8	117.5	121.9	127.1	133.7	143.5	216.8
200	91.2	105.9	108.7	111.2	114.4	118.1	122.7	127.6	134.5	144.2	218.0
210	92.5	106.5	109.2	111.7	114.9	118.6	123.3	128.3	135.2	144.9	218.7
220	93.8	106.9	109.6	112.2	115.4	119.1	123.8	128.8	135.9	145.6	219.9
230	94.7	107.3	110.1	112.6	115.9	119.6	124.2	129.4	136.3	146.0	220.4
240	96.0	107.7	110.5	113.0	116.3	120.1	124.6	129.8	136.8	146.6	221.0
250	96.5	108.1	110.9	113.4	116.7	120.5	125.1	130.2	137.5	147.0	222.7

Class 10-06

Max Moment	WPV		
	Span (FT)	Moment	Percentile of H5P
20	415.5	99.35%	99.97%
30	720.3	99.51%	99.98%
40	1043.0	99.54%	99.98%
50	1380.7	99.22%	99.96%
60	1729.9	99.00%	99.95%
70	2081.3	97.94%	99.90%
80	2586.4	98.41%	99.92%
90	3172.1	99.05%	99.95%
100	3845.2	99.21%	99.96%
110	4506.6	99.34%	99.97%
120	5164.3	99.42%	99.97%
130	5835.8	99.50%	99.97%
140	6492.5	99.54%	99.98%
150	7166.9	99.59%	99.98%
160	7844.0	99.65%	99.98%
170	8464.9	99.67%	99.98%
180	9167.9	99.71%	99.99%
190	9788.0	99.73%	99.99%
200	10467.5	99.75%	99.99%
210	11157.8	99.78%	99.99%
220	11823.2	99.79%	99.99%
230	12519.1	99.82%	99.99%
240	13184.3	99.83%	99.99%
250	13859.5	99.83%	99.99%

Class 10-06

Max Shear	WPV		
Span	Shear	Percentile of H5P	Percentile of Total
20	84.0	99.29%	99.96%
30	98.9	99.27%	99.96%
40	106.3	98.74%	99.94%
50	114.0	97.75%	99.89%
60	133.2	99.10%	99.96%
70	149.0	99.29%	99.96%
80	161.4	99.41%	99.97%
90	169.6	99.49%	99.97%
100	178.8	99.59%	99.98%
110	184.8	99.65%	99.98%
120	190.5	99.72%	99.99%
130	195.6	99.77%	99.99%
140	200.3	99.81%	99.99%
150	203.2	99.83%	99.99%
160	205.1	99.83%	99.99%
170	207.3	99.85%	99.99%
180	209.2	99.86%	99.99%
190	211.4	99.89%	99.99%
200	214.3	99.92%	100.00%
210	217.4	99.97%	100.00%
220	217.7	99.96%	100.00%
230	218.7	99.97%	100.00%
240	219.7	99.97%	100.00%
250	220.6	99.96%	100.00%

Class 10-06

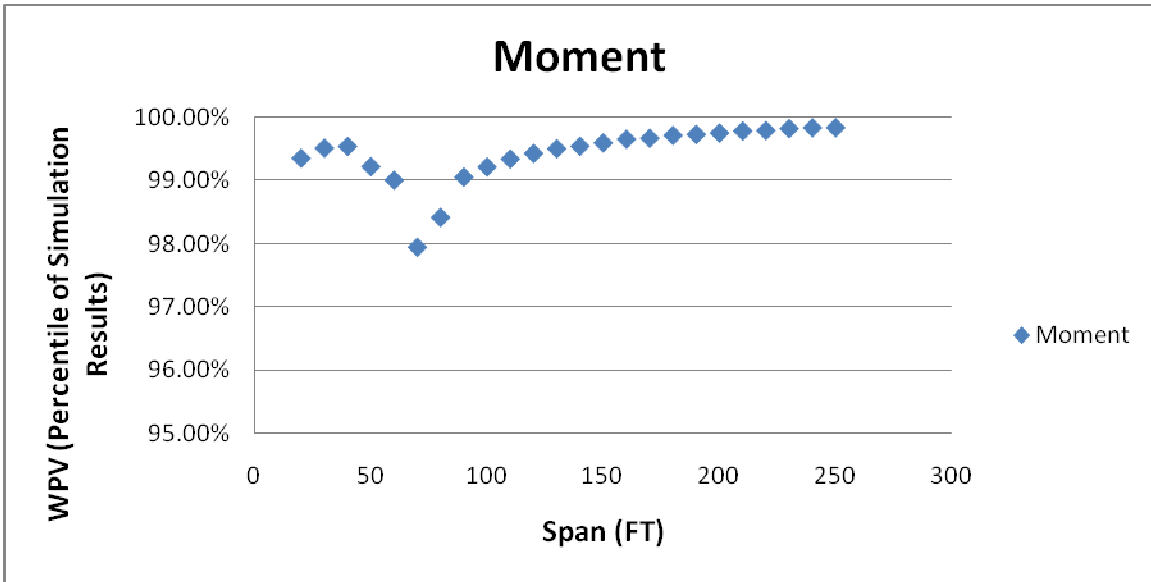

Class 10-06

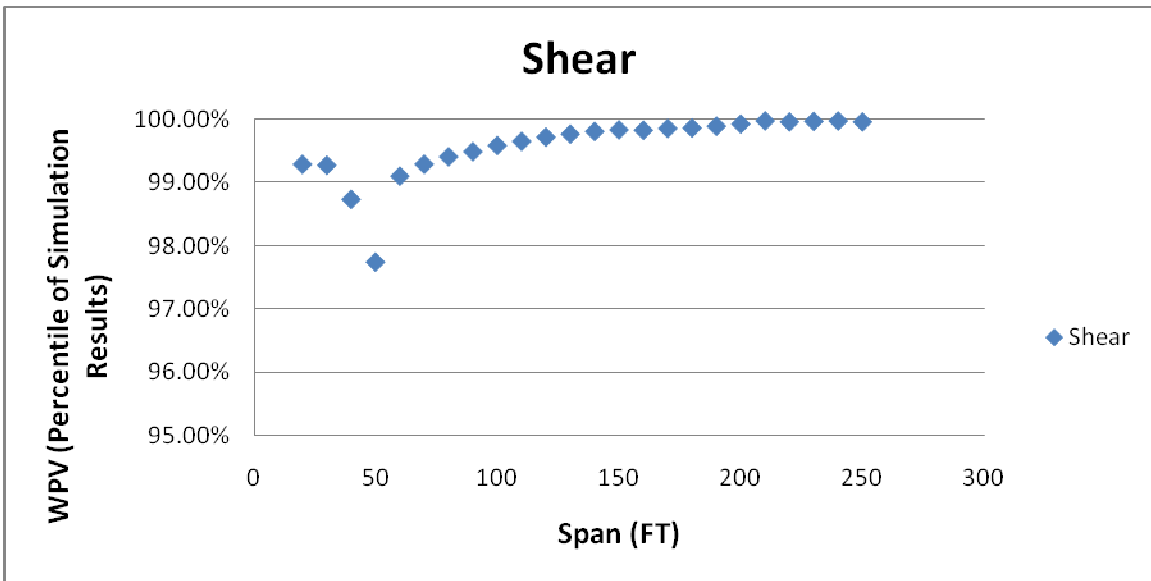

Class 11-05

	Forecast Percentile										
	0%	10%	20%	30%	40%	50%	60%	70%	80%	90%	100%
Total Length of Truck	52.36	63.64	63.99	64.27	64.34	64.57	64.64	64.90	65.36	66.06	72.66
Total Weight of Truck	115.77	118.65	120.67	122.57	124.64	126.84	129.63	132.64	136.29	141.82	171.04
FHWA Bridge Formula	80.72	87.77	87.99	88.17	88.21	88.35	88.40	88.56	88.85	89.29	93.41
Ratio FHWA WT/WT	0.52	0.62	0.65	0.67	0.68	0.70	0.71	0.72	0.73	0.74	0.78

Class 11-05

Max Moment Span (FT)	Forecast Percentile (K-FT)										
	0%	10%	20%	30%	40%	50%	60%	70%	80%	90%	100%
20	133.4	159.2	164.7	169.2	173.4	177.4	181.8	186.3	191.8	199.2	234.4
30	247.4	286.9	296.5	302.8	309.6	315.8	323.0	331.0	341.0	354.5	439.6
40	377.3	424.8	437.1	447.0	456.4	465.3	475.0	487.0	501.2	521.4	648.7
50	532.4	607.6	625.4	639.9	652.5	664.9	679.1	694.3	713.1	743.7	887.8
60	731.0	814.8	837.7	855.2	872.6	890.0	908.9	929.0	955.5	995.1	1195.7
70	958.0	1074.3	1103.9	1126.6	1148.8	1171.5	1195.9	1223.9	1257.4	1311.6	1554.1
80	1237.4	1382.9	1417.4	1445.2	1474.0	1502.0	1532.8	1571.6	1613.7	1680.7	1985.6
90	1485.5	1699.4	1740.7	1771.9	1804.5	1838.1	1877.9	1922.4	1974.7	2056.1	2447.5
100	1768.2	2021.2	2065.8	2101.9	2137.9	2178.7	2227.1	2277.8	2340.5	2437.9	2885.6
110	2063.3	2342.2	2391.1	2430.8	2471.0	2520.0	2574.4	2635.1	2706.2	2816.7	3355.9
120	2361.3	2660.0	2712.6	2757.7	2802.2	2858.5	2918.9	2987.1	3068.4	3194.0	3801.1
130	2706.4	2977.9	3033.0	3085.5	3135.2	3195.4	3262.6	3342.0	3433.1	3569.3	4247.7
140	3005.2	3294.8	3353.5	3410.4	3465.9	3530.9	3607.9	3694.4	3793.2	3943.7	4743.4
150	3314.4	3615.9	3680.2	3741.2	3801.8	3873.5	3958.4	4051.6	4161.6	4327.6	5178.2
160	3628.1	3927.4	3996.4	4062.6	4128.4	4203.5	4296.5	4398.1	4515.9	4696.4	5628.9
170	3927.6	4252.5	4325.4	4399.2	4470.3	4553.6	4654.2	4761.1	4888.8	5084.2	6067.1
180	4247.2	4568.6	4644.0	4721.8	4798.7	4889.3	4996.2	5116.5	5253.3	5462.6	6549.8
190	4538.6	4885.0	4967.0	5050.4	5130.6	5228.5	5342.6	5466.9	5615.6	5837.5	6977.6
200	4862.7	5205.7	5294.8	5383.0	5472.8	5570.0	5691.7	5828.2	5980.6	6226.0	7450.7
210	5166.6	5518.8	5609.4	5704.1	5798.7	5905.7	6030.8	6177.9	6341.5	6594.0	7917.7
220	5476.9	5831.9	5928.9	6032.2	6130.6	6241.2	6373.7	6529.0	6702.8	6970.2	8351.1
230	5772.3	6164.1	6265.6	6373.5	6474.3	6594.8	6735.1	6898.5	7083.1	7362.8	8809.3
240	6092.8	6493.1	6595.3	6712.9	6820.2	6942.8	7098.3	7266.2	7461.3	7761.0	9313.2
250	6453.1	6793.6	6905.5	7021.7	7139.9	7268.3	7425.1	7605.7	7807.0	8115.9	9765.5

Class 11-05

Max Shear	Forecast Percentile (Kips)										
	0%	10%	20%	30%	40%	50%	60%	70%	80%	90%	100%
20	33.9	38.4	39.5	40.4	41.3	42.0	43.0	43.9	45.3	47.1	58.2
30	37.6	42.3	43.5	44.4	45.3	46.2	47.2	48.3	49.7	51.7	63.7
40	43.5	49.2	50.7	52.0	53.1	54.2	55.4	56.9	58.6	61.1	74.7
50	51.5	57.6	59.2	60.5	61.6	62.9	64.2	65.8	67.9	70.7	84.8
60	57.6	64.2	65.9	67.3	68.4	69.7	71.2	72.9	75.2	78.2	93.5
70	63.6	69.5	71.0	72.3	73.6	74.9	76.5	78.2	80.5	83.7	100.9
80	69.6	74.1	75.7	76.8	78.2	79.5	81.2	83.0	85.0	88.2	105.9
90	73.0	78.6	80.1	81.3	82.6	84.1	85.9	87.6	89.8	93.0	110.8
100	76.9	82.5	84.1	85.3	86.7	88.3	90.1	92.0	94.3	97.6	116.5
110	81.0	85.8	87.3	88.6	90.1	91.6	93.6	95.6	98.0	101.5	121.4
120	83.9	88.6	90.1	91.5	92.9	94.6	96.6	98.7	101.2	104.9	126.1
130	86.5	90.9	92.5	93.9	95.4	97.1	99.1	101.3	103.9	107.8	129.0
140	88.6	92.9	94.5	96.0	97.4	99.2	101.3	103.5	106.2	110.1	132.0
150	91.0	94.5	96.1	97.6	99.1	100.9	103.0	105.3	108.0	112.1	134.7
160	92.2	96.2	97.7	99.2	100.8	102.6	104.8	107.1	109.9	114.1	136.8
170	93.7	97.3	99.0	100.5	102.1	103.9	106.1	108.5	111.4	115.5	139.0
180	95.0	98.6	100.2	101.8	103.4	105.2	107.4	109.9	112.8	117.1	140.6
190	96.3	99.6	101.2	102.8	104.4	106.3	108.6	111.0	113.9	118.3	142.6
200	97.0	100.4	102.1	103.7	105.3	107.2	109.5	112.0	114.9	119.3	143.6
210	98.1	101.4	103.0	104.7	106.3	108.3	110.5	113.1	116.1	120.4	144.9
220	98.9	102.1	103.8	105.4	107.0	109.0	111.3	113.9	116.9	121.3	145.9
230	99.6	102.8	104.5	106.2	107.8	109.8	112.1	114.7	117.7	122.2	147.2
240	100.5	103.5	105.2	106.9	108.5	110.5	112.8	115.4	118.5	123.1	148.2
250	101.0	104.1	105.8	107.5	109.2	111.2	113.5	116.2	119.2	123.8	148.5

Class 11-05

Max Moment	WPV		
Span (FT)	Moment	Percentile of H5P	Percentile of Total
20	415.5	100.00%	100.00%
30	720.3	100.00%	100.00%
40	1043.0	100.00%	100.00%
50	1380.7	100.00%	100.00%
60	1729.9	100.00%	100.00%
70	2081.3	100.00%	100.00%
80	2586.4	100.00%	100.00%
90	3172.1	100.00%	100.00%
100	3845.2	100.00%	100.00%
110	4506.6	100.00%	100.00%
120	5164.3	100.00%	100.00%
130	5835.8	100.00%	100.00%
140	6492.5	100.00%	100.00%
150	7166.9	100.00%	100.00%
160	7844.0	100.00%	100.00%
170	8464.9	100.00%	100.00%
180	9167.9	100.00%	100.00%
190	9788.0	100.00%	100.00%
200	10467.5	100.00%	100.00%
210	11157.8	100.00%	100.00%
220	11823.2	100.00%	100.00%
230	12519.1	100.00%	100.00%
240	13184.3	100.00%	100.00%
250	13859.5	100.00%	100.00%

Class 11-05

Max Shear	WPV		
Span	Shear	Percentile of H5P	Percentile of Total
20	84.0	100.00%	100.00%
30	98.9	100.00%	100.00%
40	106.3	100.00%	100.00%
50	114.0	100.00%	100.00%
60	133.2	100.00%	100.00%
70	149.0	100.00%	100.00%
80	161.4	100.00%	100.00%
90	169.6	100.00%	100.00%
100	178.8	100.00%	100.00%
110	184.8	100.00%	100.00%
120	190.5	100.00%	100.00%
130	195.6	100.00%	100.00%
140	200.3	100.00%	100.00%
150	203.2	100.00%	100.00%
160	205.1	100.00%	100.00%
170	207.3	100.00%	100.00%
180	209.2	100.00%	100.00%
190	211.4	100.00%	100.00%
200	214.3	100.00%	100.00%
210	217.4	100.00%	100.00%
220	217.7	100.00%	100.00%
230	218.7	100.00%	100.00%
240	219.7	100.00%	100.00%
250	220.6	100.00%	100.00%

Class 11-05

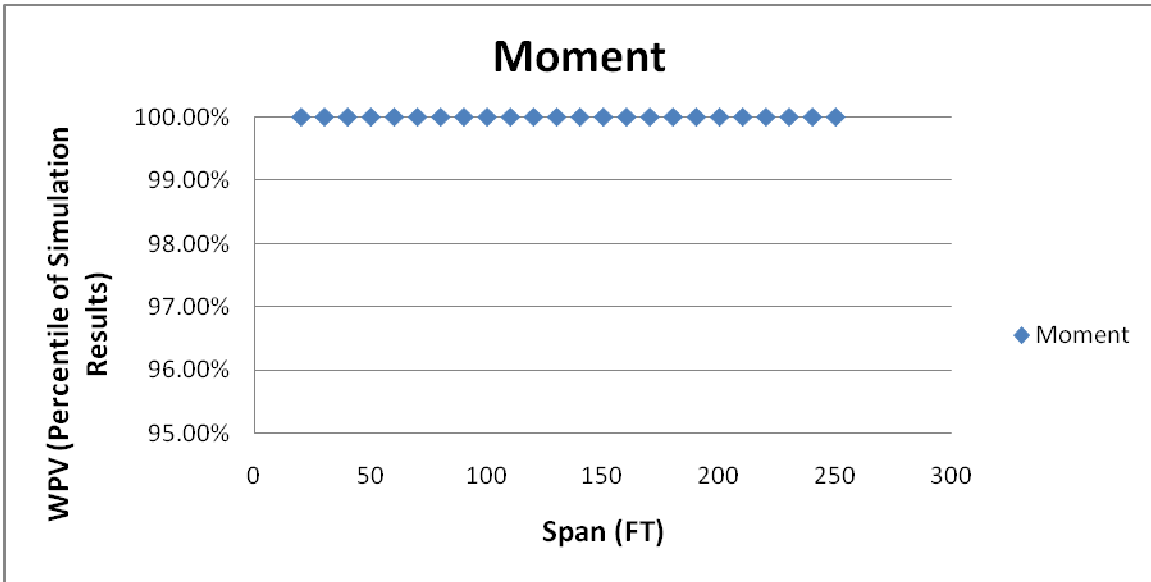

Class 11-05

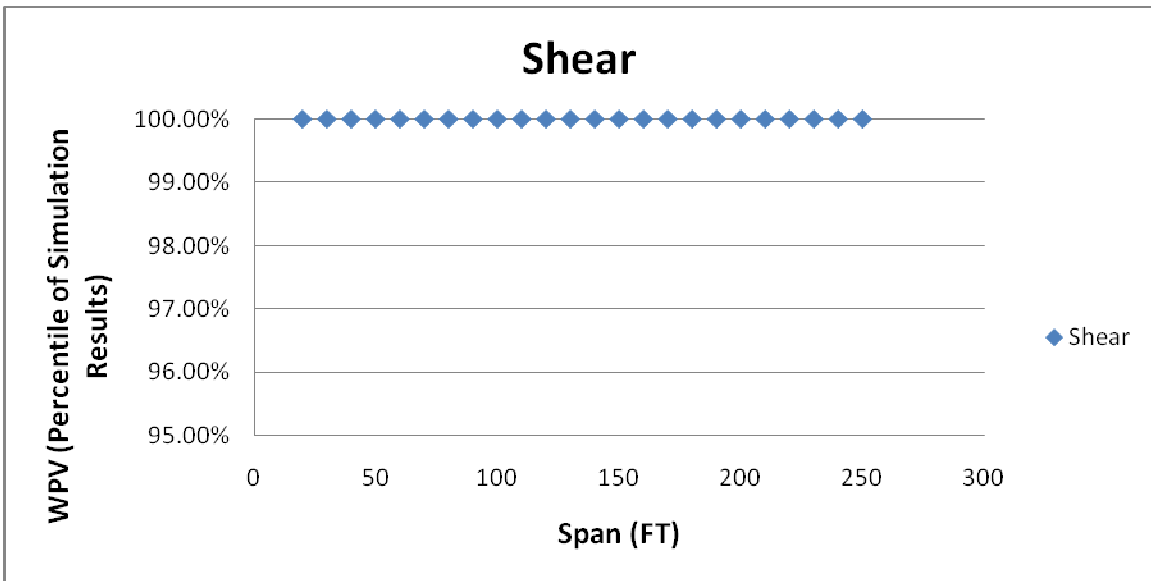

Class 12-06

	Forecast Percentile										
	0%	10%	20%	30%	40%	50%	60%	70%	80%	90%	100%
Total Length of Truck	50.71	66.69	70.32	71.10	71.85	72.46	72.86	73.25	73.86	75.51	81.67
Total Weight of Truck	128.52	131.64	133.54	135.45	137.56	140.09	142.99	146.34	150.12	156.27	197.39
FHWA Bridge Formula	84.42	94.01	96.19	96.66	97.11	97.47	97.72	97.95	98.32	99.30	103.00
Ratio FHWA WT/WT	0.50	0.62	0.65	0.66	0.68	0.69	0.70	0.71	0.73	0.74	0.78

Class 12-06

Max Moment Span (FT)	Forecast Percentile (K-FT)										
	0%	10%	20%	30%	40%	50%	60%	70%	80%	90%	100%
20	147.3	165.6	171.5	176.8	181.4	186.1	191.3	197.1	204.2	215.4	325.1
30	255.5	293.4	303.0	310.3	317.2	325.3	332.9	342.8	353.4	368.2	575.8
40	384.6	433.6	445.8	455.3	466.0	477.2	489.3	502.9	518.8	543.4	864.8
50	538.6	611.3	629.6	644.9	658.9	674.3	691.4	709.6	733.3	765.6	1162.5
60	753.5	843.1	868.1	888.4	906.3	926.8	950.0	972.8	1002.5	1048.1	1513.4
70	1011.3	1116.0	1147.5	1173.5	1195.8	1220.8	1251.3	1278.9	1318.6	1377.5	1917.0
80	1294.6	1416.7	1455.5	1486.9	1513.5	1547.0	1579.4	1616.0	1665.8	1744.5	2342.5
90	1585.4	1750.0	1792.6	1826.8	1861.7	1899.5	1938.3	1983.6	2047.3	2138.5	2776.0
100	1928.3	2104.6	2149.4	2188.7	2225.7	2267.8	2319.1	2377.1	2448.1	2558.3	3210.0
110	2281.7	2456.6	2506.0	2549.2	2593.4	2639.6	2697.8	2767.5	2845.5	2971.6	3628.7
120	2626.6	2812.8	2865.0	2914.7	2960.8	3014.6	3077.9	3160.9	3252.5	3384.6	4073.7
130	2982.9	3165.4	3224.7	3277.6	3328.2	3386.7	3462.7	3553.4	3649.8	3798.8	4607.6
140	3322.8	3518.9	3582.4	3643.4	3696.7	3758.6	3845.1	3946.9	4050.5	4214.7	5108.1
150	3657.4	3874.3	3941.8	4005.7	4067.4	4135.0	4230.5	4343.0	4451.5	4637.6	5652.0
160	3994.0	4230.6	4301.6	4369.9	4433.5	4510.7	4611.2	4731.8	4851.2	5052.2	6218.7
170	4331.5	4585.0	4661.4	4732.8	4806.6	4882.8	4995.4	5125.5	5251.2	5467.2	6751.3
180	4701.0	4935.1	5016.1	5094.9	5173.2	5258.0	5372.0	5513.0	5652.1	5874.8	7242.7
190	5043.2	5286.9	5377.1	5457.8	5540.9	5635.8	5755.0	5902.0	6053.4	6293.1	7802.2
200	5370.3	5643.4	5732.7	5816.2	5908.0	6007.4	6138.0	6294.7	6454.3	6711.2	8317.6
210	5723.2	5993.5	6099.4	6187.5	6287.8	6390.3	6527.5	6688.4	6864.8	7133.2	8809.6
220	6035.5	6342.4	6447.1	6545.4	6644.9	6757.6	6901.1	7069.7	7253.4	7544.5	9377.0
230	6413.5	6703.0	6820.4	6913.5	7025.1	7140.4	7292.0	7469.5	7666.0	7972.1	9921.6
240	6775.7	7050.6	7168.5	7270.5	7387.6	7510.3	7664.7	7860.3	8067.9	8375.5	10432.7
250	7067.2	7403.7	7525.3	7633.1	7755.5	7887.5	8041.1	8253.2	8463.4	8794.9	10996.0

Class 12-06

Max Shear	Forecast Percentile (Kips)										
	0%	10%	20%	30%	40%	50%	60%	70%	80%	90%	100%
20	33.7	38.2	39.4	40.4	41.3	42.3	43.3	44.4	45.7	47.6	69.2
30	39.4	43.4	44.6	45.6	46.6	47.7	48.8	50.2	51.7	54.1	76.8
40	46.1	51.7	53.0	54.3	55.4	56.6	57.9	59.3	60.9	63.7	84.9
50	52.6	59.1	60.5	61.8	63.1	64.6	65.9	67.4	69.6	72.7	92.7
60	60.3	66.8	68.4	69.7	71.0	72.5	74.0	75.9	78.3	81.6	100.2
70	67.2	72.9	74.6	75.9	77.2	78.7	80.4	82.3	84.8	88.2	107.0
80	71.7	77.6	79.3	80.7	82.0	83.6	85.5	87.2	89.9	93.3	114.1
90	76.4	81.5	83.4	84.9	86.4	87.9	89.8	91.7	94.4	98.0	121.0
100	80.0	85.8	87.6	89.2	90.6	92.3	94.1	96.3	98.8	102.5	128.8
110	83.5	89.7	91.6	93.2	94.7	96.3	98.4	100.4	103.1	107.0	134.8
120	87.3	93.2	95.2	96.7	98.3	99.9	102.0	104.1	106.9	110.9	140.0
130	90.8	96.2	98.1	99.6	101.3	102.9	105.1	107.2	110.2	114.3	144.2
140	93.3	98.8	100.7	102.2	103.9	105.6	107.7	109.8	112.9	117.2	148.1
150	95.7	101.0	102.8	104.3	106.2	107.9	109.8	112.3	115.3	119.8	151.7
160	97.5	102.9	104.7	106.3	108.1	109.9	111.8	114.5	117.4	121.9	154.0
170	99.8	104.6	106.4	108.0	109.8	111.6	113.6	116.3	119.2	123.8	157.0
180	101.6	106.1	108.0	109.6	111.3	113.2	115.2	118.0	121.0	125.6	158.5
190	103.1	107.5	109.3	110.9	112.7	114.6	116.6	119.5	122.4	127.2	160.9
200	103.9	108.7	110.5	112.2	113.9	115.8	117.9	120.8	123.8	128.6	162.4
210	105.5	109.8	111.6	113.3	115.0	116.8	119.1	122.0	125.2	130.0	164.4
220	106.3	110.8	112.6	114.3	116.1	117.9	120.1	123.1	126.2	131.1	165.7
230	107.1	111.7	113.5	115.2	116.9	118.9	121.1	124.2	127.3	132.3	166.7
240	108.2	112.5	114.3	115.9	117.8	119.7	121.9	125.0	128.2	133.1	168.7
250	109.4	113.2	115.1	116.7	118.6	120.5	122.7	125.8	128.9	133.9	169.7

Class 12-06

Max Moment	WPV		
	Span (FT)	Moment	Percentile of H5P
20	415.5	100.00%	100.00%
30	720.3	100.00%	100.00%
40	1043.0	100.00%	100.00%
50	1380.7	100.00%	100.00%
60	1729.9	100.00%	100.00%
70	2081.3	100.00%	100.00%
80	2586.4	100.00%	100.00%
90	3172.1	100.00%	100.00%
100	3845.2	100.00%	100.00%
110	4506.6	100.00%	100.00%
120	5164.3	100.00%	100.00%
130	5835.8	100.00%	100.00%
140	6492.5	100.00%	100.00%
150	7166.9	100.00%	100.00%
160	7844.0	100.00%	100.00%
170	8464.9	100.00%	100.00%
180	9167.9	100.00%	100.00%
190	9788.0	100.00%	100.00%
200	10467.5	100.00%	100.00%
210	11157.8	100.00%	100.00%
220	11823.2	100.00%	100.00%
230	12519.1	100.00%	100.00%
240	13184.3	100.00%	100.00%
250	13859.5	100.00%	100.00%

Class 12-06

Max Shear	WPV		
Span	Shear	Percentile of H5P	Percentile of Total
20	84.0	100.00%	100.00%
30	98.9	100.00%	100.00%
40	106.3	100.00%	100.00%
50	114.0	100.00%	100.00%
60	133.2	100.00%	100.00%
70	149.0	100.00%	100.00%
80	161.4	100.00%	100.00%
90	169.6	100.00%	100.00%
100	178.8	100.00%	100.00%
110	184.8	100.00%	100.00%
120	190.5	100.00%	100.00%
130	195.6	100.00%	100.00%
140	200.3	100.00%	100.00%
150	203.2	100.00%	100.00%
160	205.1	100.00%	100.00%
170	207.3	100.00%	100.00%
180	209.2	100.00%	100.00%
190	211.4	100.00%	100.00%
200	214.3	100.00%	100.00%
210	217.4	100.00%	100.00%
220	217.7	100.00%	100.00%
230	218.7	100.00%	100.00%
240	219.7	100.00%	100.00%
250	220.6	100.00%	100.00%

Class 12-06

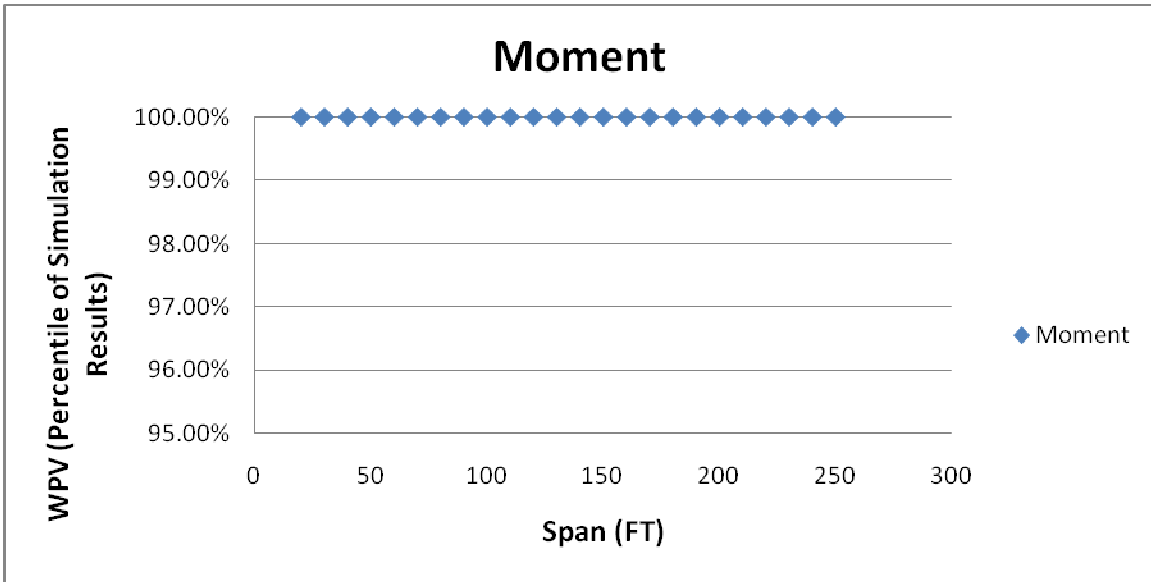

Class 12-06

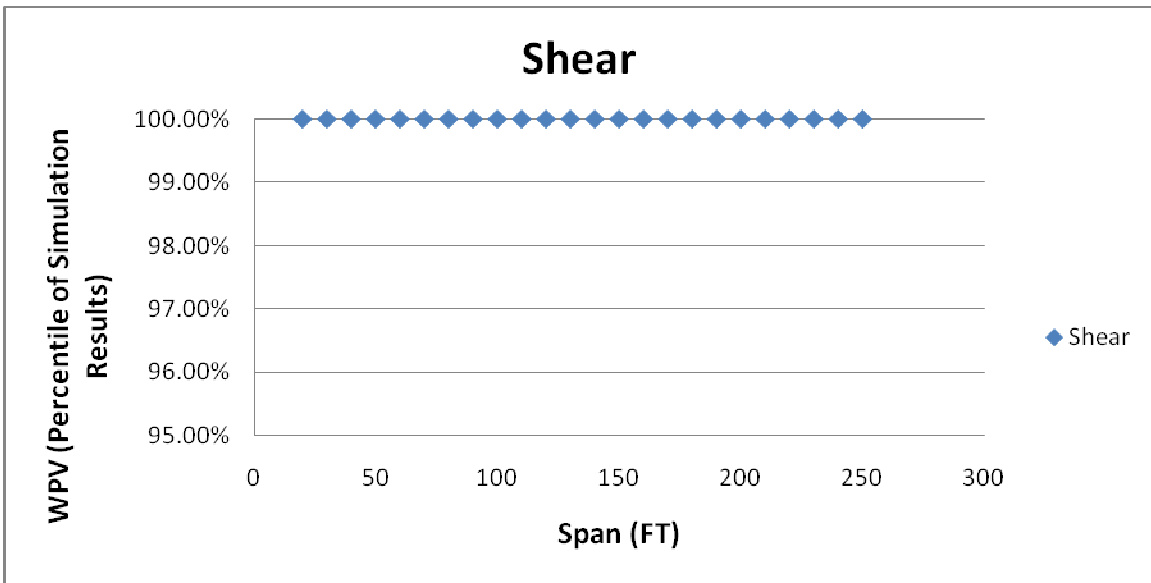

Class 13-07

	Forecast Percentile										
	0%	10%	20%	30%	40%	50%	60%	70%	80%	90%	100%
Total Length of Truck	28.75	51.89	56.99	61.40	63.12	64.63	66.38	68.75	71.18	75.71	142.66
Total Weight of Truck	119.50	130.12	133.38	137.38	142.14	147.04	155.07	163.74	176.95	189.91	281.64
FHWA Bridge Formula	71.25	90.27	93.24	95.82	96.82	97.70	98.72	100.11	101.52	104.17	143.22
Ratio FHWA WT/WT	0.36	0.52	0.56	0.59	0.63	0.65	0.68	0.70	0.72	0.75	0.84

Class 13-07

Max Moment Span (FT)	Forecast Percentile (K-FT)										
	0%	10%	20%	30%	40%	50%	60%	70%	80%	90%	100%
20	102.6	204.8	220.8	232.0	242.1	254.3	266.8	283.4	299.7	327.6	454.6
30	295.1	388.9	407.1	422.6	439.7	458.7	478.9	500.9	535.3	577.5	796.9
40	431.4	569.3	593.6	616.0	644.6	672.0	699.5	733.5	774.7	845.7	1252.9
50	593.2	765.1	796.6	830.3	866.5	906.2	947.8	990.3	1043.5	1139.5	1751.4
60	846.6	959.9	1009.9	1061.4	1107.1	1156.0	1216.2	1266.5	1335.9	1456.6	2379.4
70	1007.2	1155.6	1221.3	1285.8	1365.4	1429.9	1491.2	1571.8	1661.6	1815.9	3074.7
80	1180.9	1376.1	1455.7	1534.2	1627.4	1717.2	1796.2	1896.0	2012.3	2207.5	3799.3
90	1365.3	1640.8	1751.8	1849.7	1941.4	2050.0	2150.9	2261.6	2408.7	2647.0	4506.5
100	1634.2	1966.3	2089.7	2210.5	2304.4	2429.4	2541.5	2661.6	2837.6	3110.7	5207.2
110	1939.6	2308.7	2443.2	2576.4	2693.9	2825.8	2938.6	3083.5	3273.4	3590.8	5944.2
120	2266.2	2660.2	2810.5	2950.6	3084.4	3223.5	3343.6	3509.7	3719.8	4082.1	6727.6
130	2597.6	3012.5	3179.4	3325.6	3470.5	3618.7	3750.9	3933.0	4178.4	4586.6	7476.6
140	2929.9	3367.0	3549.6	3704.2	3857.2	4010.3	4164.5	4352.2	4628.2	5082.3	8215.5
150	3281.4	3721.8	3916.2	4077.7	4235.7	4405.2	4579.8	4771.1	5087.8	5586.8	8989.8
160	3589.0	4076.3	4280.7	4452.7	4617.0	4795.5	4990.8	5193.8	5553.6	6094.5	9794.3
170	3960.3	4432.4	4648.2	4822.8	4997.1	5191.1	5405.5	5627.3	6027.7	6591.1	10480.5
180	4270.0	4787.8	5010.0	5190.2	5378.5	5584.1	5812.6	6057.2	6497.7	7095.5	11237.8
190	4630.9	5142.0	5372.2	5561.6	5756.7	5976.3	6217.3	6502.2	6967.6	7591.2	12089.2
200	4954.4	5489.8	5727.4	5933.9	6136.4	6377.0	6620.3	6943.7	7440.3	8088.2	12804.3
210	5302.8	5842.0	6094.9	6301.4	6515.4	6767.5	7028.2	7377.6	7906.4	8588.0	13467.1
220	5607.0	6196.5	6451.1	6676.8	6891.2	7165.4	7442.3	7816.6	8391.9	9089.9	14230.5
230	5958.2	6546.3	6816.2	7049.5	7269.6	7560.2	7852.1	8254.4	8853.2	9580.6	15058.3
240	6297.6	6894.7	7179.8	7418.0	7641.3	7956.7	8267.6	8687.2	9320.5	10077.8	15817.6
250	6632.2	7252.1	7538.1	7793.3	8020.4	8348.9	8674.4	9119.8	9795.9	10575.6	16538.6

Class 13-07

Max Shear	Forecast Percentile (Kips)										
	0%	10%	20%	30%	40%	50%	60%	70%	80%	90%	100%
20	20.8	44.4	47.2	49.4	51.7	53.8	56.4	59.3	63.3	68.8	108.4
30	43.3	54.2	56.7	58.7	61.2	63.7	66.2	69.6	73.6	80.1	130.6
40	49.1	59.1	61.8	64.8	67.5	70.5	73.5	76.6	81.1	88.3	142.4
50	53.2	63.3	66.6	69.7	73.1	76.5	79.9	83.4	88.6	96.7	148.8
60	56.5	68.4	72.4	76.3	79.4	82.8	86.7	91.0	96.1	105.8	162.8
70	62.0	75.1	79.3	83.3	87.0	90.2	94.3	98.9	104.6	115.2	172.8
80	65.6	81.7	85.9	89.7	93.7	96.8	101.1	105.5	112.0	123.3	184.0
90	72.0	87.2	91.3	94.9	98.8	102.0	106.8	111.4	118.4	129.9	193.7
100	77.7	91.7	95.8	99.3	103.1	106.5	111.4	116.3	123.7	135.3	203.7
110	82.1	95.5	99.5	102.9	106.6	110.1	115.1	120.4	128.2	140.2	210.3
120	85.9	98.5	102.5	105.8	109.5	113.2	118.1	124.0	132.1	144.0	216.3
130	88.9	101.1	105.0	108.3	112.1	115.7	120.7	127.1	135.5	147.3	222.0
140	92.2	103.2	107.1	110.5	114.2	118.1	122.8	129.6	138.6	150.0	225.3
150	93.9	105.1	108.9	112.3	116.0	120.0	124.7	131.9	141.0	152.9	229.9
160	96.6	106.7	110.5	113.9	117.4	121.7	126.5	133.7	143.4	155.1	232.3
170	97.6	108.1	111.9	115.3	118.8	123.3	128.1	135.6	145.3	156.8	236.1
180	99.7	109.4	113.1	116.6	120.1	124.6	129.5	137.2	147.0	158.6	236.9
190	100.9	110.5	114.2	117.7	121.1	125.8	130.8	138.6	148.7	160.1	240.9
200	102.1	111.4	115.2	118.7	122.1	126.9	132.1	139.8	150.1	161.4	242.8
210	102.3	112.4	116.1	119.6	122.9	127.9	132.8	141.1	151.5	162.8	243.0
220	103.9	113.2	116.8	120.4	123.9	128.7	134.1	142.0	152.9	163.9	245.2
230	104.2	114.0	117.6	121.1	124.7	129.5	134.9	143.2	153.7	164.9	248.4
240	105.6	114.6	118.3	121.7	125.4	130.1	135.6	143.9	154.7	166.2	248.6
250	106.1	115.2	118.9	122.3	126.2	130.8	136.3	144.6	155.7	167.2	249.1

Class 13-07

Max Moment	WPV		
Span (FT)	Moment	Percentile of H5P	Percentile of Total
20	415.5	99.23%	99.96%
30	720.3	99.13%	99.96%
40	1043.0	99.02%	99.95%
50	1380.7	98.38%	99.92%
60	1729.9	97.27%	99.86%
70	2081.3	96.30%	99.82%
80	2586.4	96.64%	99.83%
90	3172.1	97.10%	99.86%
100	3845.2	97.59%	99.88%
110	4506.6	97.99%	99.90%
120	5164.3	98.20%	99.91%
130	5835.8	98.41%	99.92%
140	6492.5	98.54%	99.93%
150	7166.9	98.76%	99.94%
160	7844.0	98.93%	99.95%
170	8464.9	98.90%	99.94%
180	9167.9	99.03%	99.95%
190	9788.0	99.02%	99.95%
200	10467.5	99.05%	99.95%
210	11157.8	99.06%	99.95%
220	11823.2	99.07%	99.95%
230	12519.1	99.09%	99.95%
240	13184.3	99.10%	99.95%
250	13859.5	99.11%	99.96%

Class 13-07

Max Shear	WPV		
Span	Shear	Percentile of H5P	Percentile of Total
20	84.0	99.01%	99.95%
30	98.9	99.01%	99.95%
40	106.3	98.08%	99.90%
50	114.0	97.20%	99.86%
60	133.2	98.45%	99.92%
70	149.0	99.02%	99.95%
80	161.4	99.11%	99.96%
90	169.6	99.10%	99.96%
100	178.8	99.18%	99.96%
110	184.8	99.20%	99.96%
120	190.5	99.22%	99.96%
130	195.6	99.25%	99.96%
140	200.3	99.28%	99.96%
150	203.2	99.26%	99.96%
160	205.1	99.24%	99.96%
170	207.3	99.22%	99.96%
180	209.2	99.22%	99.96%
190	211.4	99.22%	99.96%
200	214.3	99.24%	99.96%
210	217.4	99.29%	99.96%
220	217.7	99.26%	99.96%
230	218.7	99.23%	99.96%
240	219.7	99.23%	99.96%
250	220.6	99.24%	99.96%

Class 13-07

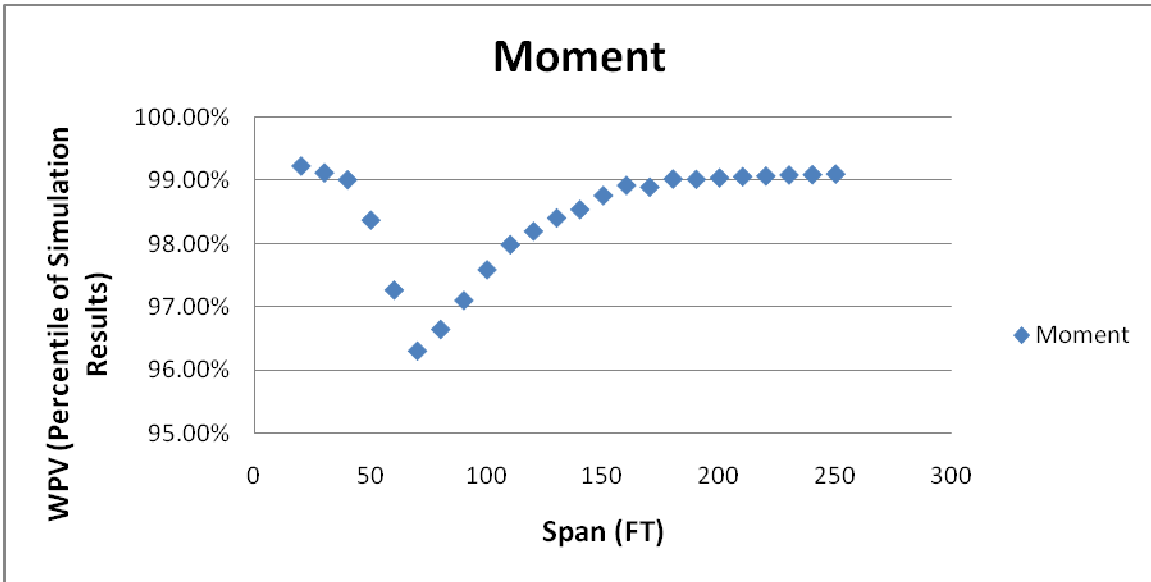

Class 13-07

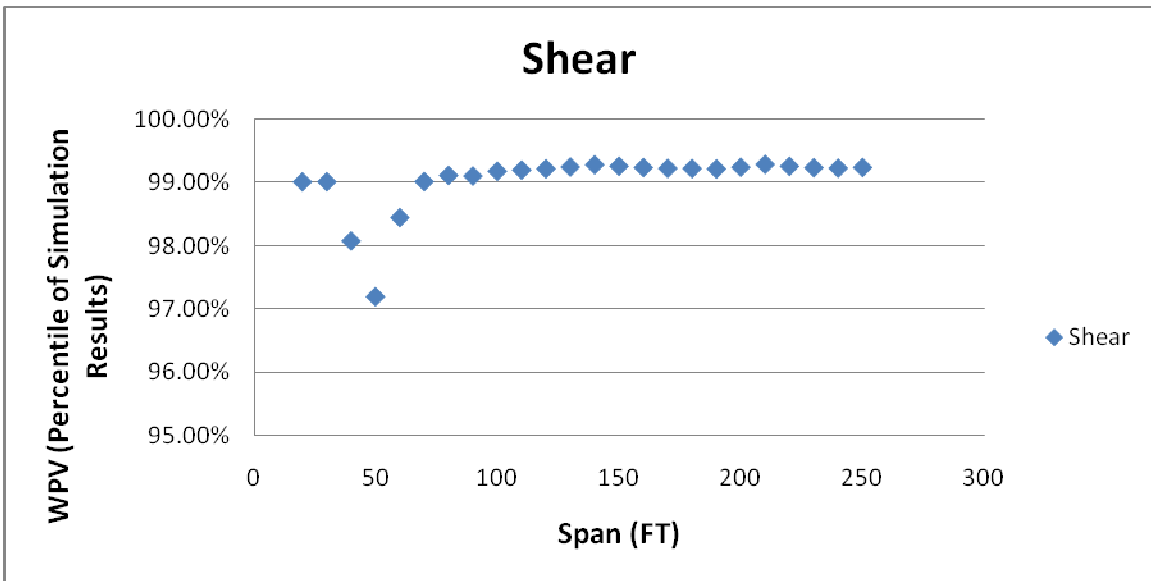

Class 15-03

	Forecast Percentile										
	0%	10%	20%	30%	40%	50%	60%	70%	80%	90%	100%
Total Length of Truck	3.95	9.37	13.23	15.98	17.98	19.59	20.73	22.02	23.29	27.57	88.26
Total Weight of Truck	21.23	27.44	28.27	29.13	30.27	31.60	32.83	34.35	36.67	39.46	55.77
FHWA Bridge Formula	38.96	43.02	45.93	47.98	49.49	50.70	51.55	52.51	53.47	56.67	102.19
Ratio FHWA WT/WT	0.78	1.18	1.31	1.44	1.53	1.61	1.69	1.77	1.84	1.94	3.48

Class 15-03

Max Moment Span (FT)	Forecast Percentile (K-FT)										
	0%	10%	20%	30%	40%	50%	60%	70%	80%	90%	100%
20	39.9	74.7	80.5	85.0	89.6	94.8	102.1	111.1	123.6	147.0	220.3
30	79.5	117.8	126.9	135.3	143.0	152.0	164.5	179.3	202.7	240.0	358.4
40	116.0	169.9	185.1	197.8	210.6	224.9	239.8	261.0	293.1	338.0	503.5
50	152.0	239.7	258.9	275.6	291.4	307.5	326.7	351.7	388.2	437.3	650.8
60	209.9	315.6	337.2	355.8	374.5	393.4	417.1	443.2	487.2	538.4	800.6
70	248.6	392.3	415.7	435.6	457.6	480.2	505.2	535.6	585.5	641.9	941.4
80	319.0	468.6	493.7	515.2	540.1	566.5	593.2	629.1	685.2	747.9	1094.3
90	375.2	545.4	571.6	595.7	623.1	651.2	682.2	722.3	783.9	852.6	1243.8
100	444.5	622.3	649.6	675.7	705.8	736.8	771.5	816.5	884.2	958.2	1396.0
110	520.4	698.3	727.9	756.3	788.6	822.3	861.0	911.0	983.9	1065.2	1551.1
120	588.4	775.3	805.4	836.3	871.5	908.5	949.8	1004.3	1082.3	1173.5	1698.1
130	659.9	850.9	883.2	916.7	953.7	994.9	1039.4	1097.5	1181.7	1280.5	1846.2
140	737.3	927.5	961.5	997.2	1036.7	1081.1	1129.0	1191.0	1282.1	1389.4	2000.8
150	800.4	1003.3	1039.2	1077.0	1119.3	1167.9	1218.4	1285.7	1382.0	1496.0	2157.2
160	861.2	1078.4	1116.7	1156.2	1201.9	1254.1	1308.2	1378.7	1482.0	1605.2	2294.8
170	919.7	1154.4	1194.6	1236.8	1283.5	1340.2	1397.5	1472.3	1581.2	1711.8	2453.5
180	973.8	1230.2	1272.7	1316.5	1367.1	1426.3	1488.2	1565.5	1681.3	1817.0	2597.8
190	1033.1	1305.8	1350.5	1396.9	1449.1	1513.2	1577.9	1658.4	1781.2	1924.0	2751.7
200	1087.4	1381.5	1428.4	1476.5	1532.9	1599.6	1667.6	1751.9	1880.7	2031.5	2896.6
210	1147.6	1457.5	1506.0	1556.9	1615.2	1687.3	1757.8	1845.0	1981.7	2139.8	3060.2
220	1202.2	1531.2	1583.8	1634.7	1698.7	1772.6	1845.7	1938.2	2082.5	2245.3	3206.0
230	1261.2	1607.9	1660.7	1714.2	1782.9	1858.9	1936.1	2032.4	2183.2	2354.0	3342.7
240	1322.6	1683.0	1738.0	1794.2	1863.5	1944.6	2026.6	2125.6	2282.4	2463.3	3509.6
250	1377.7	1757.0	1815.9	1873.6	1947.2	2031.5	2116.6	2218.8	2381.3	2566.7	3655.8

Class 15-03

Max Shear	Forecast Percentile (Kips)										
	0%	10%	20%	30%	40%	50%	60%	70%	80%	90%	100%
20	7.2	15.0	16.3	17.5	18.6	19.9	21.1	22.8	25.6	29.8	45.6
30	12.1	18.4	19.7	20.9	22.0	23.1	24.5	26.1	28.7	32.0	48.2
40	13.7	20.7	21.9	22.9	24.0	25.0	26.4	28.0	30.6	33.5	49.4
50	15.5	22.1	23.1	24.1	25.1	26.2	27.5	29.1	31.7	34.6	50.6
60	16.2	23.0	24.0	24.9	25.9	27.0	28.3	30.0	32.5	35.3	51.2
70	17.7	23.6	24.6	25.5	26.5	27.6	28.8	30.6	33.0	35.9	51.7
80	18.8	24.1	25.1	25.9	26.9	28.0	29.3	31.0	33.5	36.3	52.1
90	19.7	24.5	25.4	26.3	27.3	28.4	29.6	31.3	33.8	36.6	52.4
100	20.0	24.8	25.7	26.6	27.6	28.7	29.9	31.6	34.0	36.9	52.6
110	20.0	25.1	25.9	26.8	27.8	28.9	30.2	31.8	34.3	37.0	52.9
120	20.2	25.3	26.1	27.0	28.0	29.2	30.4	32.0	34.4	37.2	53.0
130	20.3	25.5	26.3	27.1	28.2	29.3	30.6	32.1	34.6	37.3	53.1
140	20.3	25.6	26.5	27.3	28.3	29.5	30.7	32.3	34.7	37.5	53.3
150	20.3	25.7	26.6	27.4	28.5	29.6	30.9	32.4	34.9	37.6	53.4
160	20.4	25.8	26.7	27.5	28.6	29.8	31.0	32.5	35.0	37.6	53.4
170	20.5	25.9	26.8	27.6	28.7	29.9	31.1	32.6	35.1	37.8	53.5
180	20.5	26.0	26.8	27.7	28.8	30.0	31.2	32.7	35.1	37.8	53.5
190	20.5	26.1	26.9	27.7	28.8	30.0	31.3	32.8	35.2	37.9	53.6
200	20.5	26.1	27.0	27.8	28.9	30.1	31.4	32.9	35.3	38.0	53.6
210	20.6	26.2	27.0	27.9	29.0	30.2	31.4	32.9	35.3	38.0	53.8
220	20.6	26.3	27.1	27.9	29.0	30.2	31.5	33.0	35.4	38.1	53.9
230	20.7	26.3	27.1	28.0	29.1	30.3	31.6	33.1	35.4	38.2	53.7
240	20.7	26.3	27.2	28.0	29.1	30.4	31.6	33.1	35.5	38.2	53.9
250	20.7	26.4	27.2	28.1	29.2	30.4	31.7	33.2	35.5	38.2	54.1

Class 15-03

Max Moment	WPV		
Span (FT)	Moment	Percentile of H5P	Percentile of Total
20	415.5	100.00%	100.00%
30	720.3	100.00%	100.00%
40	1043.0	100.00%	100.00%
50	1380.7	100.00%	100.00%
60	1729.9	100.00%	100.00%
70	2081.3	100.00%	100.00%
80	2586.4	100.00%	100.00%
90	3172.1	100.00%	100.00%
100	3845.2	100.00%	100.00%
110	4506.6	100.00%	100.00%
120	5164.3	100.00%	100.00%
130	5835.8	100.00%	100.00%
140	6492.5	100.00%	100.00%
150	7166.9	100.00%	100.00%
160	7844.0	100.00%	100.00%
170	8464.9	100.00%	100.00%
180	9167.9	100.00%	100.00%
190	9788.0	100.00%	100.00%
200	10467.5	100.00%	100.00%
210	11157.8	100.00%	100.00%
220	11823.2	100.00%	100.00%
230	12519.1	100.00%	100.00%
240	13184.3	100.00%	100.00%
250	13859.5	100.00%	100.00%

Class 15-03

Max Shear	WPV		
Span	Shear	Percentile of H5P	Percentile of Total
20	84.0	100.00%	100.00%
30	98.9	100.00%	100.00%
40	106.3	100.00%	100.00%
50	114.0	100.00%	100.00%
60	133.2	100.00%	100.00%
70	149.0	100.00%	100.00%
80	161.4	100.00%	100.00%
90	169.6	100.00%	100.00%
100	178.8	100.00%	100.00%
110	184.8	100.00%	100.00%
120	190.5	100.00%	100.00%
130	195.6	100.00%	100.00%
140	200.3	100.00%	100.00%
150	203.2	100.00%	100.00%
160	205.1	100.00%	100.00%
170	207.3	100.00%	100.00%
180	209.2	100.00%	100.00%
190	211.4	100.00%	100.00%
200	214.3	100.00%	100.00%
210	217.4	100.00%	100.00%
220	217.7	100.00%	100.00%
230	218.7	100.00%	100.00%
240	219.7	100.00%	100.00%
250	220.6	100.00%	100.00%

Class 15-03

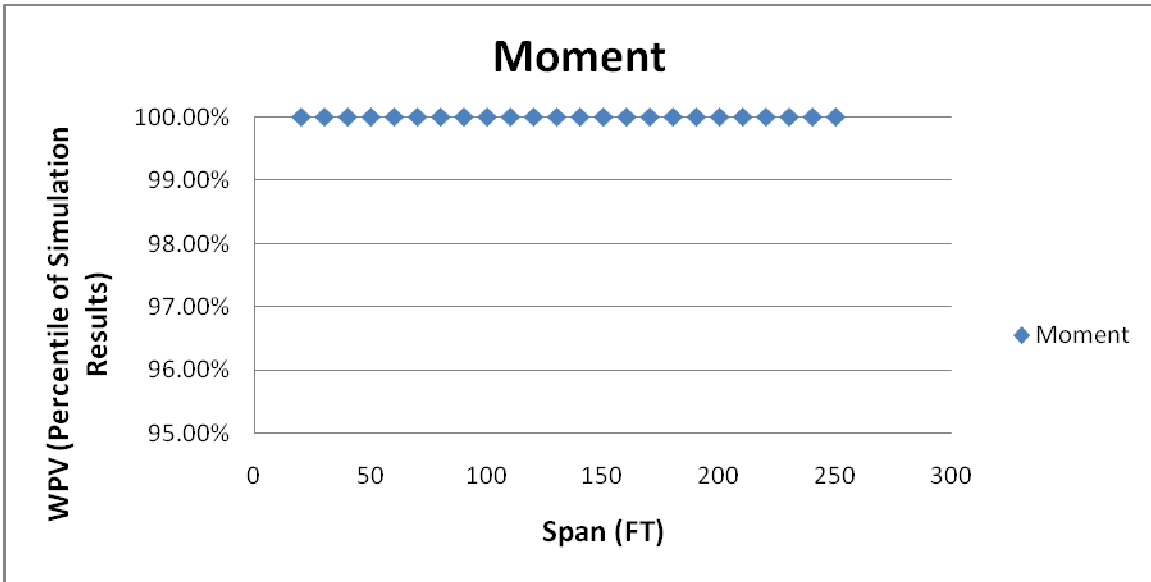

Class 15-03

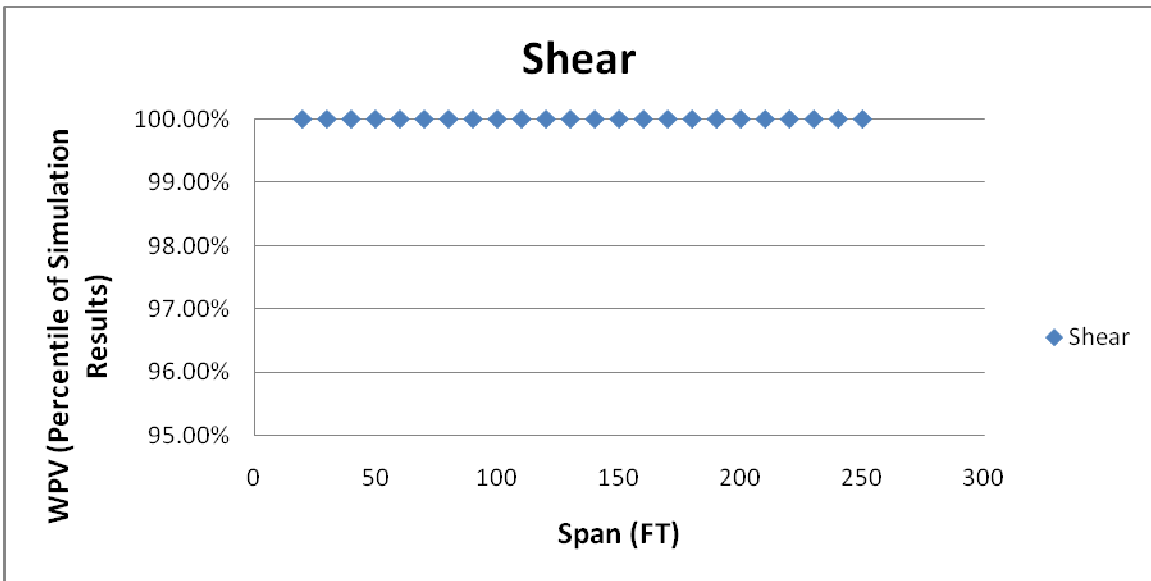

Class 15-04

	Forecast Percentile										
	0%	10%	20%	30%	40%	50%	60%	70%	80%	90%	100%
Total Length of Truck	12.29	19.01	19.92	20.42	20.87	21.34	22.02	23.29	25.37	46.62	291.97
Total Weight of Truck	53.85	57.51	58.40	59.16	59.93	60.73	61.87	63.69	65.79	69.61	94.38
FHWA Bridge Formula	45.55	54.68	55.28	55.62	55.91	56.23	56.68	57.53	58.92	73.08	236.64
Ratio FHWA WT/WT	0.62	0.81	0.86	0.89	0.91	0.93	0.95	0.97	0.99	1.20	4.15

Class 15-04

Max Moment Span (FT)	Forecast Percentile (K-FT)										
	0%	10%	20%	30%	40%	50%	60%	70%	80%	90%	100%
20	52.0	128.4	149.2	157.2	162.9	168.4	173.8	180.6	189.4	200.4	259.9
30	78.0	221.9	258.6	269.3	277.3	285.0	295.4	306.1	320.6	339.3	450.4
40	104.0	316.7	385.6	411.8	424.3	435.7	447.4	463.0	480.5	508.4	644.8
50	131.7	424.6	539.6	568.3	583.1	597.4	610.6	629.6	653.9	690.6	870.8
60	159.4	549.9	698.3	725.9	741.9	759.6	775.5	796.7	828.4	875.0	1095.3
70	185.9	707.0	855.9	883.5	901.5	920.7	939.8	966.4	1002.7	1059.0	1323.9
80	212.8	862.5	1012.6	1040.9	1060.1	1082.3	1103.1	1134.7	1177.9	1244.6	1550.3
90	239.4	1024.2	1171.9	1199.2	1220.4	1244.3	1267.9	1305.3	1355.4	1431.6	1800.3
100	514.8	1187.4	1328.5	1356.5	1380.9	1406.7	1432.3	1475.4	1530.7	1617.9	2063.1
110	600.4	1352.6	1486.5	1515.2	1541.5	1569.6	1597.9	1645.8	1709.6	1805.5	2310.6
120	692.1	1517.6	1644.5	1674.4	1703.4	1732.0	1764.4	1819.5	1886.7	1994.1	2565.8
130	813.3	1681.6	1802.4	1834.8	1865.0	1896.4	1932.1	1990.0	2063.5	2182.2	2828.3
140	932.6	1847.4	1961.1	1994.9	2027.2	2061.8	2098.1	2160.2	2242.5	2369.8	3081.1
150	1060.0	2009.0	2119.5	2155.7	2189.2	2225.5	2266.2	2333.2	2421.0	2557.5	3338.9
160	1182.1	2172.5	2275.2	2316.5	2352.5	2389.6	2433.9	2505.8	2600.5	2746.1	3581.4
170	1311.8	2335.2	2434.2	2476.9	2516.1	2554.8	2604.2	2677.6	2777.9	2935.3	3826.2
180	1446.8	2498.8	2594.4	2635.4	2679.8	2722.9	2772.7	2853.2	2958.3	3135.7	4096.5
190	1549.7	2659.7	2753.4	2798.8	2841.7	2887.9	2940.8	3023.8	3137.6	3313.7	4347.7
200	1631.3	2818.5	2911.2	2956.4	3005.3	3051.8	3109.4	3199.2	3316.6	3512.6	4601.9
210	1726.3	2977.9	3074.0	3120.6	3168.0	3218.4	3278.6	3369.8	3495.6	3690.1	4858.2
220	1808.5	3137.0	3230.5	3279.5	3331.7	3383.0	3447.8	3547.1	3675.2	3894.0	5117.4
230	1890.7	3294.7	3392.6	3445.7	3492.2	3549.6	3615.5	3719.6	3856.9	4078.4	5378.7
240	2005.7	3452.6	3548.9	3603.6	3657.3	3712.2	3783.7	3895.6	4031.5	4277.1	5612.5
250	2125.6	3609.9	3707.9	3766.3	3820.0	3876.3	3951.8	4067.4	4212.8	4459.3	5909.2

Class 15-04

Max Shear	Forecast Percentile (Kips)										
	0%	10%	20%	30%	40%	50%	60%	70%	80%	90%	100%
20	9.4	28.1	32.3	34.0	35.3	36.2	37.5	38.9	40.5	43.0	53.7
30	9.4	30.7	39.1	41.3	42.6	43.7	44.8	46.0	48.1	50.5	63.6
40	9.4	33.9	44.1	45.7	46.8	47.8	48.8	50.1	52.1	55.0	68.9
50	9.6	37.5	46.9	48.4	49.3	50.3	51.3	52.6	54.7	57.7	71.8
60	9.6	40.9	48.8	50.0	50.9	51.9	52.9	54.4	56.4	59.6	75.2
70	9.7	43.9	50.1	51.2	52.1	53.0	54.1	55.6	57.7	61.0	78.1
80	9.7	45.7	51.1	52.1	53.0	53.9	54.9	56.5	58.7	62.0	80.0
90	24.6	47.4	51.9	52.8	53.7	54.6	55.6	57.3	59.4	62.8	81.2
100	25.2	48.8	52.5	53.4	54.3	55.1	56.2	57.8	60.0	63.4	82.8
110	25.9	50.0	53.0	53.9	54.7	55.6	56.6	58.3	60.5	64.0	83.5
120	27.9	50.9	53.4	54.3	55.1	55.9	57.0	58.7	60.9	64.5	84.7
130	29.3	51.7	53.7	54.7	55.4	56.3	57.4	59.0	61.2	64.8	85.4
140	30.4	52.2	54.1	55.0	55.7	56.6	57.7	59.3	61.5	65.1	85.9
150	31.6	52.7	54.3	55.2	56.0	56.8	57.9	59.6	61.8	65.4	86.4
160	33.1	53.0	54.5	55.4	56.2	57.1	58.1	59.8	62.0	65.7	87.1
170	34.7	53.3	54.8	55.7	56.4	57.3	58.4	60.0	62.2	65.9	87.3
180	36.1	53.6	54.9	55.8	56.6	57.4	58.5	60.2	62.4	66.1	87.8
190	37.3	53.8	55.1	56.0	56.7	57.6	58.7	60.4	62.6	66.2	88.5
200	37.4	54.0	55.3	56.1	56.9	57.7	58.8	60.5	62.7	66.4	88.3
210	38.5	54.1	55.4	56.3	57.0	57.9	58.9	60.7	62.9	66.5	88.9
220	39.2	54.3	55.5	56.4	57.1	58.0	59.0	60.8	63.0	66.7	88.7
230	39.7	54.4	55.7	56.5	57.2	58.1	59.2	60.9	63.1	66.8	89.4
240	40.1	54.6	55.7	56.6	57.3	58.1	59.3	61.0	63.2	66.9	89.4
250	41.1	54.7	55.8	56.7	57.4	58.3	59.3	61.1	63.3	67.0	89.9

Class 15-04

Max Moment	WPV		
Span (FT)	Moment	Percentile of H5P	Percentile of Total
415.5	415.5	100.00%	100.00%
720.3	720.3	100.00%	100.00%
1043.0	1043.0	100.00%	100.00%
1380.7	1380.7	100.00%	100.00%
1729.9	1729.9	100.00%	100.00%
2081.3	2081.3	100.00%	100.00%
2586.4	2586.4	100.00%	100.00%
3172.1	3172.1	100.00%	100.00%
3845.2	3845.2	100.00%	100.00%
4506.6	4506.6	100.00%	100.00%
5164.3	5164.3	100.00%	100.00%
5835.8	5835.8	100.00%	100.00%
6492.5	6492.5	100.00%	100.00%
7166.9	7166.9	100.00%	100.00%
7844.0	7844.0	100.00%	100.00%
8464.9	8464.9	100.00%	100.00%
9167.9	9167.9	100.00%	100.00%
9788.0	9788.0	100.00%	100.00%
10467.5	10467.5	100.00%	100.00%
11157.8	11157.8	100.00%	100.00%
11823.2	11823.2	100.00%	100.00%
12519.1	12519.1	100.00%	100.00%
13184.3	13184.3	100.00%	100.00%
13859.5	13859.5	100.00%	100.00%

Class 15-04

Max Shear	WPV		
Span	Shear	Percentile of H5P	Percentile of Total
20	84.0	100.00%	100.00%
30	98.9	100.00%	100.00%
40	106.3	100.00%	100.00%
50	114.0	100.00%	100.00%
60	133.2	100.00%	100.00%
70	149.0	100.00%	100.00%
80	161.4	100.00%	100.00%
90	169.6	100.00%	100.00%
100	178.8	100.00%	100.00%
110	184.8	100.00%	100.00%
120	190.5	100.00%	100.00%
130	195.6	100.00%	100.00%
140	200.3	100.00%	100.00%
150	203.2	100.00%	100.00%
160	205.1	100.00%	100.00%
170	207.3	100.00%	100.00%
180	209.2	100.00%	100.00%
190	211.4	100.00%	100.00%
200	214.3	100.00%	100.00%
210	217.4	100.00%	100.00%
220	217.7	100.00%	100.00%
230	218.7	100.00%	100.00%
240	219.7	100.00%	100.00%
250	220.6	100.00%	100.00%

Class 15-04

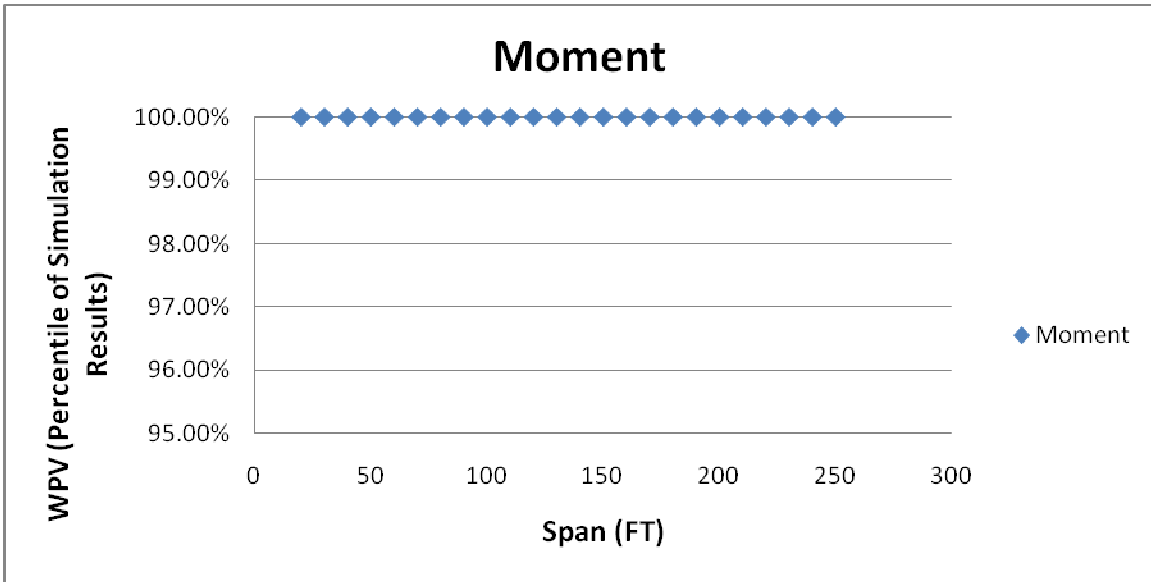

Class 15-04

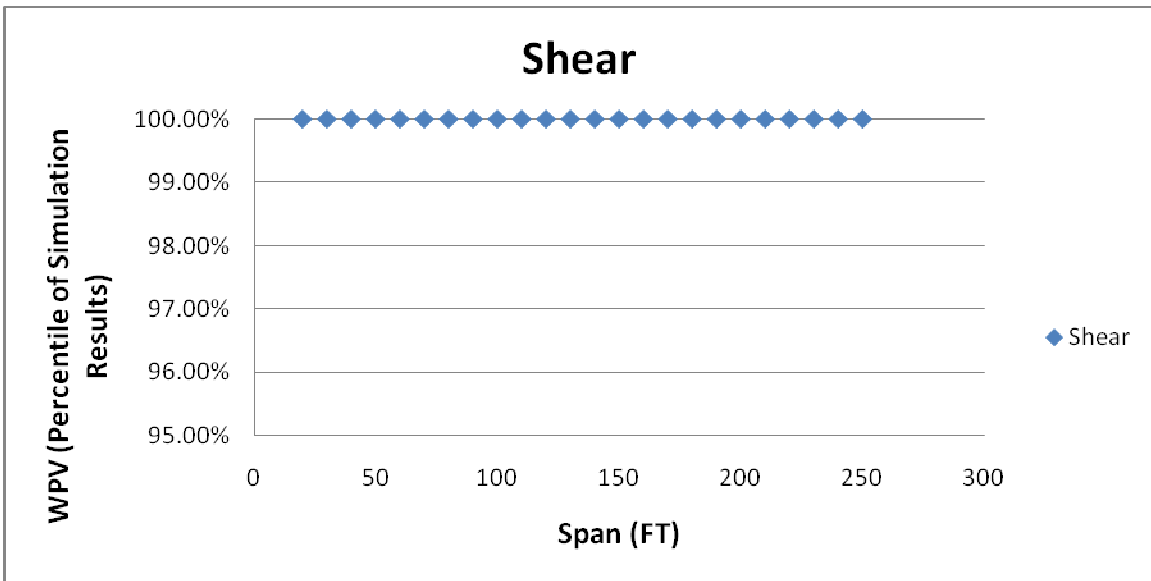

Class 15-05

	Forecast Percentile										
	0%	10%	20%	30%	40%	50%	60%	70%	80%	90%	100%
Total Length of Truck	16.42	21.53	21.94	22.32	22.76	23.30	27.81	29.37	30.50	56.46	127.10
Total Weight of Truck	70.89	74.35	75.48	76.46	77.42	78.44	79.65	81.32	83.43	86.02	105.35
FHWA Bridge Formula	52.95	61.46	61.71	61.95	62.22	62.56	65.38	66.36	67.06	83.28	127.44
Ratio FHWA WT/WT	0.62	0.73	0.76	0.78	0.79	0.81	0.83	0.86	0.88	1.07	1.61

Class 15-05

Max Moment Span (FT)	Forecast Percentile (K-FT)										
	0%	10%	20%	30%	40%	50%	60%	70%	80%	90%	100%
20	76.4	148.0	179.6	195.3	203.7	209.5	215.3	222.2	230.4	240.6	285.8
30	141.4	265.2	331.5	351.5	363.1	372.1	382.0	392.0	405.6	421.9	496.8
40	220.0	385.0	495.3	523.4	540.1	553.6	568.2	585.2	606.4	626.2	735.2
50	337.8	513.7	679.5	715.4	736.6	757.6	776.6	796.7	823.0	852.8	1001.3
60	446.2	652.8	881.0	919.6	942.5	966.2	988.3	1012.1	1044.7	1082.3	1274.1
70	554.7	802.6	1082.5	1123.9	1150.1	1176.4	1201.3	1228.3	1266.5	1312.5	1542.9
80	665.1	980.7	1284.9	1326.6	1356.9	1384.1	1413.8	1443.9	1486.8	1541.3	1814.1
90	818.9	1173.8	1485.7	1531.3	1564.3	1593.6	1626.9	1661.1	1708.5	1770.1	2089.8
100	991.1	1370.2	1687.3	1735.4	1771.6	1802.2	1840.7	1878.2	1932.2	1999.2	2351.7
110	1159.2	1571.9	1889.6	1939.9	1977.1	2012.2	2056.4	2096.4	2153.6	2229.0	2615.9
120	1299.3	1778.5	2091.1	2143.7	2185.1	2221.9	2267.5	2313.6	2377.2	2458.0	2885.3
130	1461.2	1990.7	2294.3	2348.0	2390.7	2433.7	2484.3	2535.3	2603.7	2689.0	3188.7
140	1581.0	2208.7	2496.7	2552.7	2598.2	2642.3	2699.1	2751.4	2828.5	2920.2	3448.8
150	1701.8	2427.8	2698.8	2758.0	2806.4	2853.8	2914.8	2971.3	3052.3	3151.8	3717.6
160	1835.3	2642.6	2901.2	2962.8	3012.6	3064.6	3129.4	3191.5	3277.8	3386.3	4020.1
170	2025.7	2853.4	3104.3	3167.5	3221.3	3275.7	3344.9	3412.7	3501.8	3616.4	4311.5
180	2208.4	3072.4	3310.6	3376.4	3433.7	3489.2	3557.7	3635.3	3728.6	3847.5	4592.0
190	2403.1	3281.2	3512.9	3581.8	3640.5	3700.2	3775.2	3852.5	3954.5	4082.1	4870.6
200	2600.2	3495.6	3714.0	3787.9	3848.3	3912.4	3990.5	4073.6	4178.2	4313.4	5195.2
210	2761.1	3707.1	3920.9	3991.7	4058.1	4126.0	4205.6	4294.6	4408.1	4547.9	5433.0
220	2917.4	3919.8	4123.9	4199.5	4266.7	4336.1	4423.2	4518.8	4636.1	4784.3	5766.8
230	3129.1	4131.4	4331.5	4407.5	4478.3	4551.2	4639.7	4735.1	4862.4	5015.6	6028.9
240	3295.0	4340.4	4530.1	4614.8	4684.3	4759.5	4850.8	4951.6	5081.5	5244.1	6326.9
250	3512.0	4547.9	4736.7	4822.8	4898.0	4972.4	5073.8	5178.5	5318.3	5492.0	6590.5

Class 15-05

Max Shear	Forecast Percentile (Kips)										
	Span	0%	10%	20%	30%	40%	50%	60%	70%	80%	90%
20	16.0	32.4	39.4	41.9	43.4	44.7	45.9	47.5	49.1	51.3	60.4
30	21.3	37.6	46.6	49.1	51.3	53.2	54.7	56.3	58.2	60.8	71.2
40	24.8	40.5	53.5	55.7	57.4	59.1	60.5	62.2	64.2	66.9	78.4
50	30.6	44.3	57.7	59.7	61.2	62.7	64.1	65.8	67.8	70.5	82.0
60	34.4	47.7	60.4	62.4	63.8	65.2	66.5	68.2	70.3	72.9	85.7
70	37.7	51.2	62.4	64.3	65.6	66.9	68.3	70.0	72.1	74.6	87.7
80	39.7	54.2	63.9	65.7	66.9	68.3	69.7	71.3	73.4	75.9	89.4
90	41.7	56.8	65.1	66.8	68.0	69.3	70.7	72.3	74.4	77.0	90.4
100	41.9	58.9	66.0	67.8	68.9	70.2	71.6	73.1	75.3	77.8	91.3
110	42.3	60.8	66.8	68.4	69.6	70.8	72.3	73.8	76.0	78.5	92.8
120	44.6	62.2	67.4	69.0	70.2	71.4	72.8	74.4	76.5	79.0	93.7
130	46.8	63.4	68.1	69.5	70.7	71.9	73.3	74.9	77.1	79.5	94.6
140	48.8	64.5	68.6	69.9	71.1	72.3	73.8	75.3	77.5	80.0	95.5
150	50.3	65.4	69.0	70.3	71.5	72.7	74.1	75.7	77.9	80.3	95.8
160	51.8	66.2	69.4	70.7	71.8	73.0	74.5	76.0	78.2	80.6	96.5
170	53.0	66.9	69.7	71.0	72.1	73.3	74.7	76.3	78.5	80.9	97.6
180	54.2	67.4	70.0	71.3	72.4	73.6	74.9	76.5	78.7	81.2	97.9
190	55.0	67.9	70.3	71.5	72.7	73.8	75.2	76.8	79.0	81.3	97.4
200	56.1	68.3	70.6	71.8	72.9	74.0	75.4	77.0	79.1	81.6	98.1
210	56.8	68.6	70.7	71.9	73.0	74.2	75.6	77.2	79.4	81.8	98.6
220	57.4	69.0	71.0	72.1	73.2	74.4	75.8	77.4	79.5	82.0	99.2
230	58.3	69.2	71.2	72.3	73.4	74.5	75.9	77.5	79.7	82.0	99.2
240	58.9	69.4	71.3	72.4	73.5	74.7	76.0	77.6	79.8	82.2	99.5
250	59.3	69.7	71.5	72.6	73.7	74.8	76.2	77.8	80.0	82.4	99.5

Class 15-05

Max Moment	WPV		
Span (FT)	Moment	Percentile of H5P	Percentile of Total
415.5	415.5	100.00%	100.00%
720.3	720.3	100.00%	100.00%
1043.0	1043.0	100.00%	100.00%
1380.7	1380.7	100.00%	100.00%
1729.9	1729.9	100.00%	100.00%
2081.3	2081.3	100.00%	100.00%
2586.4	2586.4	100.00%	100.00%
3172.1	3172.1	100.00%	100.00%
3845.2	3845.2	100.00%	100.00%
4506.6	4506.6	100.00%	100.00%
5164.3	5164.3	100.00%	100.00%
5835.8	5835.8	100.00%	100.00%
6492.5	6492.5	100.00%	100.00%
7166.9	7166.9	100.00%	100.00%
7844.0	7844.0	100.00%	100.00%
8464.9	8464.9	100.00%	100.00%
9167.9	9167.9	100.00%	100.00%
9788.0	9788.0	100.00%	100.00%
10467.5	10467.5	100.00%	100.00%
11157.8	11157.8	100.00%	100.00%
11823.2	11823.2	100.00%	100.00%
12519.1	12519.1	100.00%	100.00%
13184.3	13184.3	100.00%	100.00%
13859.5	13859.5	100.00%	100.00%

Class 15-05

Max Shear	WPV		
Span	Shear	Percentile of H5P	Percentile of Total
20	84.0	100.00%	100.00%
30	98.9	100.00%	100.00%
40	106.3	100.00%	100.00%
50	114.0	100.00%	100.00%
60	133.2	100.00%	100.00%
70	149.0	100.00%	100.00%
80	161.4	100.00%	100.00%
90	169.6	100.00%	100.00%
100	178.8	100.00%	100.00%
110	184.8	100.00%	100.00%
120	190.5	100.00%	100.00%
130	195.6	100.00%	100.00%
140	200.3	100.00%	100.00%
150	203.2	100.00%	100.00%
160	205.1	100.00%	100.00%
170	207.3	100.00%	100.00%
180	209.2	100.00%	100.00%
190	211.4	100.00%	100.00%
200	214.3	100.00%	100.00%
210	217.4	100.00%	100.00%
220	217.7	100.00%	100.00%
230	218.7	100.00%	100.00%
240	219.7	100.00%	100.00%
250	220.6	100.00%	100.00%

Class 15-05

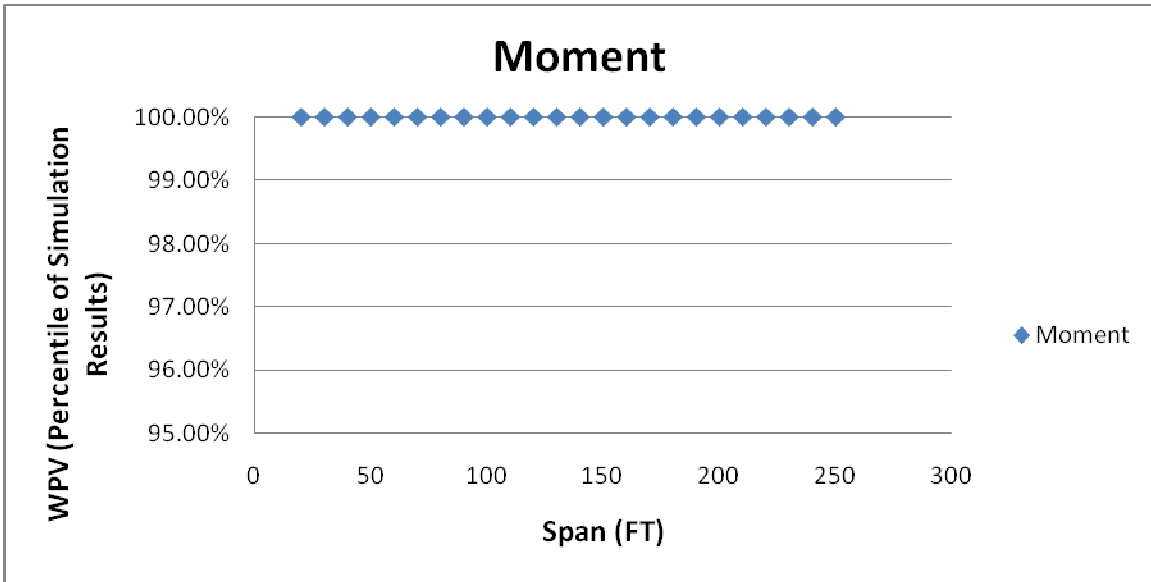

Class 15-05

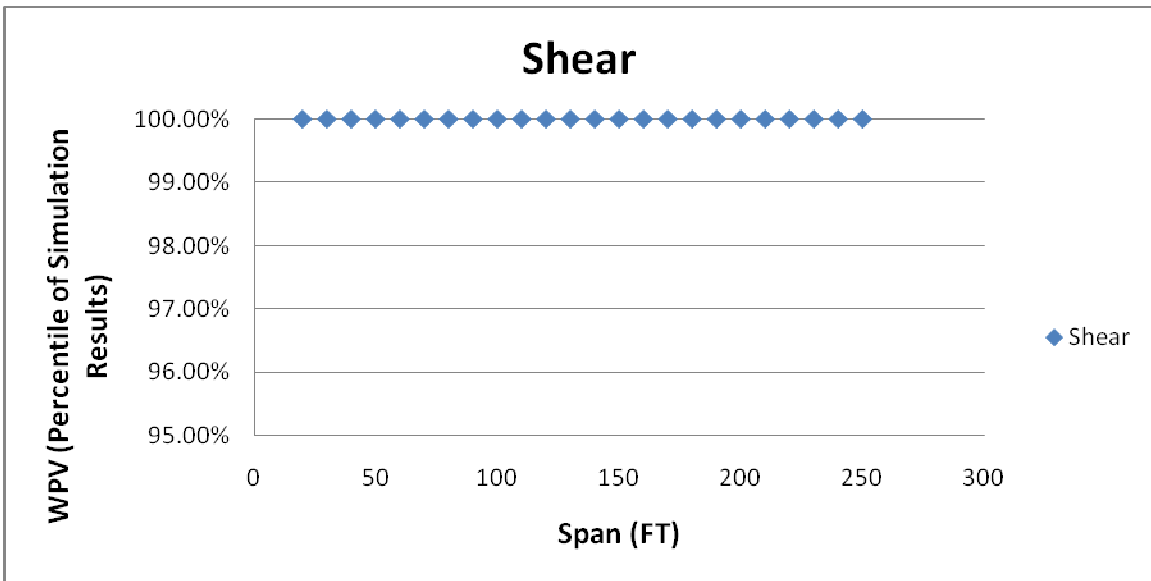

Class 15-06

	Forecast Percentile										
	0%	10%	20%	30%	40%	50%	60%	70%	80%	90%	100%
Total Length of Truck	12.56	54.64	57.02	58.20	59.23	60.08	60.93	61.96	63.45	65.79	81.24
Total Weight of Truck	89.58	93.06	93.71	94.36	95.19	96.22	97.39	98.71	100.41	103.31	133.27
FHWA Bridge Formula	55.85	86.78	88.21	88.92	89.54	90.05	90.56	91.18	92.07	93.47	102.75
Ratio FHWA WT/WT	0.59	0.86	0.89	0.91	0.92	0.93	0.94	0.95	0.97	0.98	1.09

Class 15-06

Max Moment Span (FT)	Forecast Percentile (K-FT)										
	0%	10%	20%	30%	40%	50%	60%	70%	80%	90%	100%
20	108.4	142.5	149.8	155.3	160.1	165.2	169.9	175.4	181.4	191.1	299.4
30	227.0	268.9	281.3	289.3	296.6	303.8	311.6	320.0	330.3	346.2	559.6
40	338.3	389.7	402.2	413.0	422.3	430.5	439.0	449.8	462.1	485.6	813.8
50	453.5	523.4	536.7	546.1	558.6	569.6	579.0	590.5	606.7	636.5	1080.0
60	593.0	660.6	676.1	689.0	700.4	712.0	725.8	740.6	760.4	797.2	1383.2
70	732.3	806.4	826.9	840.9	854.8	871.8	887.7	906.3	933.6	977.3	1680.2
80	890.3	986.9	1013.2	1034.9	1056.2	1076.1	1099.8	1124.5	1161.6	1215.8	2017.1
90	1082.2	1212.9	1245.8	1271.6	1296.7	1321.6	1345.2	1378.6	1417.5	1477.8	2366.1
100	1305.3	1457.0	1490.6	1519.9	1548.5	1572.6	1599.3	1634.6	1678.7	1747.4	2724.1
110	1529.3	1705.2	1740.1	1771.7	1801.3	1828.0	1857.1	1894.8	1945.4	2017.8	3082.8
120	1738.6	1955.8	1993.3	2025.9	2056.3	2085.8	2117.0	2155.9	2211.3	2290.0	3429.0
130	1961.1	2207.1	2245.7	2280.8	2311.6	2341.7	2376.6	2418.8	2477.1	2560.7	3793.0
140	2229.6	2458.2	2499.5	2535.0	2566.5	2599.2	2635.7	2682.7	2744.3	2837.8	4153.0
150	2478.4	2710.0	2752.2	2789.1	2822.3	2856.0	2895.3	2946.6	3010.3	3112.2	4492.2
160	2722.3	2961.1	3004.8	3042.1	3076.4	3114.6	3155.8	3208.5	3280.4	3387.6	4847.9
170	2977.8	3211.4	3257.4	3295.8	3332.4	3371.7	3416.9	3470.3	3546.0	3663.5	5227.1
180	3216.8	3460.3	3510.0	3548.8	3586.0	3627.6	3678.7	3735.2	3812.4	3935.4	5578.4
190	3442.8	3712.7	3761.3	3801.4	3841.3	3886.9	3939.8	3998.2	4081.8	4210.7	5931.3
200	3712.4	3960.8	4013.0	4054.1	4096.8	4142.6	4201.7	4261.7	4349.6	4483.6	6280.2
210	3981.5	4213.3	4264.9	4307.8	4351.6	4402.7	4463.1	4527.1	4618.7	4763.9	6629.4
220	4215.0	4464.2	4517.2	4560.4	4607.0	4661.4	4722.7	4790.9	4883.1	5040.5	6985.5
230	4467.7	4713.8	4768.2	4813.3	4864.9	4919.6	4982.8	5057.5	5154.1	5314.4	7360.6
240	4734.0	4964.4	5020.3	5067.6	5120.1	5178.4	5246.9	5322.3	5424.4	5592.5	7728.2
250	4987.4	5212.5	5272.4	5318.7	5376.9	5436.4	5505.9	5586.2	5693.4	5872.0	8055.5

Class 15-06

Max Shear	Forecast Percentile (Kips)										
	0%	10%	20%	30%	40%	50%	60%	70%	80%	90%	100%
20	22.3	30.9	32.9	34.3	35.3	36.2	37.1	38.4	40.1	42.2	66.4
30	33.8	38.1	39.1	39.8	40.6	41.5	42.3	43.2	44.6	46.7	76.1
40	37.8	41.2	42.3	43.2	44.0	44.7	45.6	46.6	48.0	50.2	81.1
50	40.8	45.6	46.9	47.8	48.7	49.6	50.7	51.9	53.4	55.8	85.7
60	44.8	49.8	51.1	52.5	53.6	54.8	56.2	57.4	59.1	61.3	89.8
70	49.1	55.0	56.5	57.9	59.1	60.1	61.5	62.7	64.4	66.7	93.8
80	51.3	59.8	61.2	62.4	63.5	64.5	65.8	67.0	68.7	71.1	95.9
90	55.0	63.5	65.0	66.1	67.1	68.0	69.2	70.4	72.1	74.7	98.5
100	58.7	66.6	67.9	69.0	69.9	70.8	72.0	73.2	74.9	77.6	102.6
110	61.9	69.1	70.4	71.3	72.2	73.1	74.2	75.4	77.1	79.9	104.8
120	64.1	71.1	72.4	73.3	74.1	75.0	76.1	77.3	79.0	81.8	106.8
130	66.4	72.8	74.0	75.0	75.8	76.7	77.7	79.0	80.7	83.5	108.7
140	68.3	74.3	75.5	76.4	77.1	78.1	79.1	80.3	82.0	84.9	110.8
150	69.9	75.6	76.7	77.6	78.4	79.3	80.3	81.6	83.2	86.2	112.3
160	71.3	76.7	77.8	78.7	79.4	80.3	81.3	82.6	84.3	87.2	113.3
170	72.5	77.7	78.8	79.6	80.4	81.2	82.3	83.5	85.2	88.2	115.1
180	73.5	78.6	79.6	80.4	81.2	82.0	83.1	84.3	86.1	89.0	115.7
190	74.5	79.4	80.4	81.1	81.9	82.8	83.9	85.1	86.8	89.6	117.2
200	75.3	80.1	81.0	81.8	82.6	83.5	84.5	85.8	87.5	90.3	117.6
210	76.0	80.7	81.7	82.4	83.2	84.1	85.1	86.4	88.1	90.9	118.3
220	76.6	81.3	82.2	83.0	83.8	84.6	85.7	86.9	88.7	91.5	119.0
230	77.2	81.8	82.7	83.5	84.3	85.1	86.2	87.5	89.2	91.9	119.5
240	77.5	82.3	83.2	83.9	84.8	85.6	86.7	87.9	89.6	92.3	120.4
250	78.5	82.7	83.6	84.3	85.2	86.0	87.1	88.3	90.0	92.8	120.8

Class 15-06

Max Moment	WPV		
Span (FT)	Moment	Percentile of H5P	Percentile of Total
415.5	415.5	100.00%	100.00%
720.3	720.3	100.00%	100.00%
1043.0	1043.0	100.00%	100.00%
1380.7	1380.7	100.00%	100.00%
1729.9	1729.9	100.00%	100.00%
2081.3	2081.3	100.00%	100.00%
2586.4	2586.4	100.00%	100.00%
3172.1	3172.1	100.00%	100.00%
3845.2	3845.2	100.00%	100.00%
4506.6	4506.6	100.00%	100.00%
5164.3	5164.3	100.00%	100.00%
5835.8	5835.8	100.00%	100.00%
6492.5	6492.5	100.00%	100.00%
7166.9	7166.9	100.00%	100.00%
7844.0	7844.0	100.00%	100.00%
8464.9	8464.9	100.00%	100.00%
9167.9	9167.9	100.00%	100.00%
9788.0	9788.0	100.00%	100.00%
10467.5	10467.5	100.00%	100.00%
11157.8	11157.8	100.00%	100.00%
11823.2	11823.2	100.00%	100.00%
12519.1	12519.1	100.00%	100.00%
13184.3	13184.3	100.00%	100.00%
13859.5	13859.5	100.00%	100.00%

Class 15-06

Max Shear	WPV		
Span	Shear	Percentile of H5P	Percentile of Total
20	84.0	100.00%	100.00%
30	98.9	100.00%	100.00%
40	106.3	100.00%	100.00%
50	114.0	100.00%	100.00%
60	133.2	100.00%	100.00%
70	149.0	100.00%	100.00%
80	161.4	100.00%	100.00%
90	169.6	100.00%	100.00%
100	178.8	100.00%	100.00%
110	184.8	100.00%	100.00%
120	190.5	100.00%	100.00%
130	195.6	100.00%	100.00%
140	200.3	100.00%	100.00%
150	203.2	100.00%	100.00%
160	205.1	100.00%	100.00%
170	207.3	100.00%	100.00%
180	209.2	100.00%	100.00%
190	211.4	100.00%	100.00%
200	214.3	100.00%	100.00%
210	217.4	100.00%	100.00%
220	217.7	100.00%	100.00%
230	218.7	100.00%	100.00%
240	219.7	100.00%	100.00%
250	220.6	100.00%	100.00%

Class 15-06

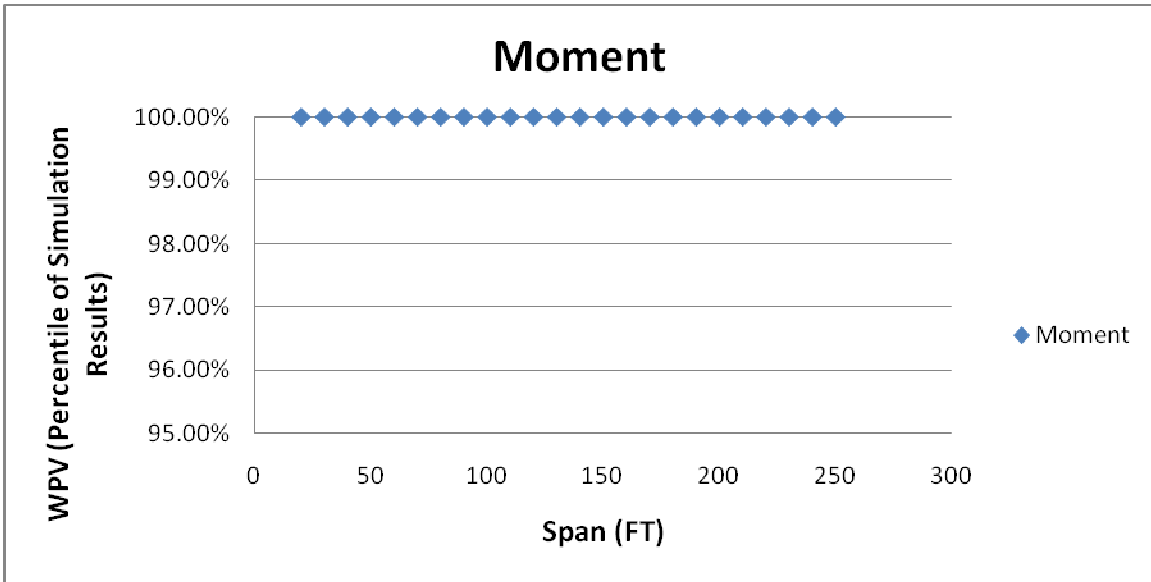

Class 15-06

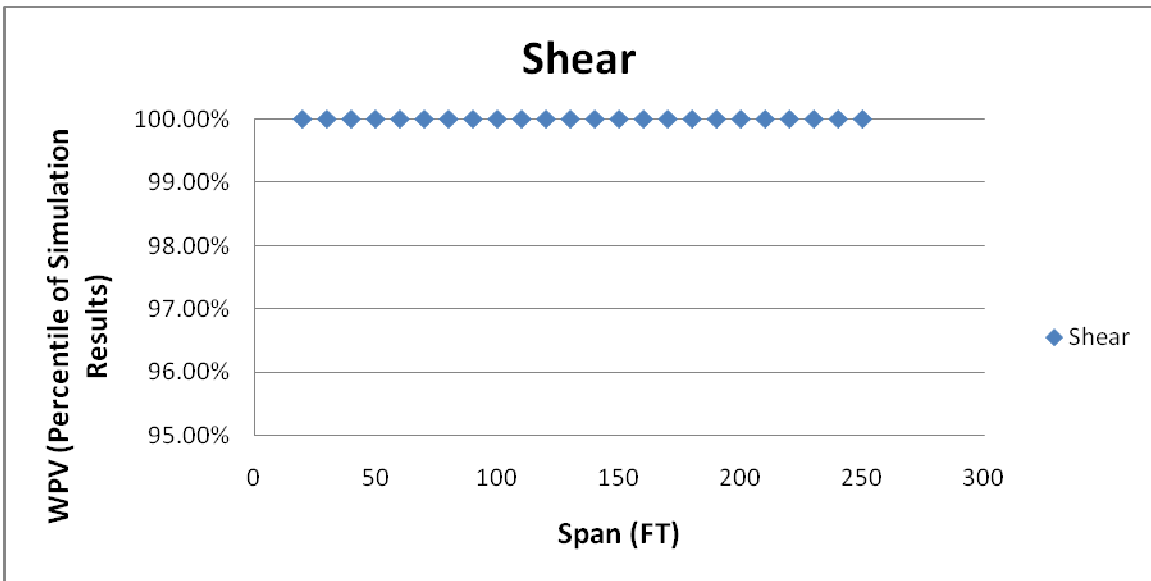

Moment	Percentile of H5P														
	Class 05-06	Class 06-03	Class 07-04	Class 07-05	Class 08-03	Class 08-04	Class 09-05	Class 10-06	Class 11-05	Class 12-06	Class 13-07	Class 15-03	Class 15-04	Class 15-05	Class 15-06
20	100.00%	99.37%	99.21%	99.03%	100.00%	100.00%	100.00%	99.35%	100.00%	100.00%	99.23%	100.00%	100.00%	100.00%	100.00%
30	100.00%	99.57%	99.26%	98.53%	100.00%	100.00%	100.00%	99.51%	100.00%	100.00%	99.13%	100.00%	100.00%	100.00%	100.00%
40	100.00%	99.69%	99.27%	97.95%	100.00%	100.00%	100.00%	99.54%	100.00%	100.00%	99.02%	100.00%	100.00%	100.00%	100.00%
50	100.00%	99.77%	99.22%	97.07%	100.00%	100.00%	100.00%	99.22%	100.00%	100.00%	98.38%	100.00%	100.00%	100.00%	100.00%
60	100.00%	99.82%	99.19%	96.56%	100.00%	100.00%	99.80%	99.00%	100.00%	100.00%	97.27%	100.00%	100.00%	100.00%	100.00%
70	100.00%	99.86%	99.17%	95.98%	100.00%	100.00%	99.61%	97.94%	100.00%	100.00%	96.30%	100.00%	100.00%	100.00%	100.00%
80	100.00%	100.00%	99.30%	98.37%	100.00%	100.00%	99.62%	98.41%	100.00%	100.00%	96.64%	100.00%	100.00%	100.00%	100.00%
90	100.00%	100.00%	99.47%	99.30%	100.00%	100.00%	99.68%	99.05%	100.00%	100.00%	97.10%	100.00%	100.00%	100.00%	100.00%
100	100.00%	100.00%	99.67%	99.79%	100.00%	100.00%	99.77%	99.21%	100.00%	100.00%	97.59%	100.00%	100.00%	100.00%	100.00%
110	100.00%	100.00%	99.82%	100.00%	100.00%	100.00%	99.86%	99.34%	100.00%	100.00%	97.99%	100.00%	100.00%	100.00%	100.00%
120	100.00%	100.00%	99.94%	100.00%	100.00%	100.00%	99.93%	99.42%	100.00%	100.00%	98.20%	100.00%	100.00%	100.00%	100.00%
130	100.00%	100.00%	100.00%	100.00%	100.00%	100.00%	99.97%	99.50%	100.00%	100.00%	98.41%	100.00%	100.00%	100.00%	100.00%
140	100.00%	100.00%	100.00%	100.00%	100.00%	100.00%	100.00%	99.54%	100.00%	100.00%	98.54%	100.00%	100.00%	100.00%	100.00%
150	100.00%	100.00%	100.00%	100.00%	100.00%	100.00%	100.00%	99.59%	100.00%	100.00%	98.76%	100.00%	100.00%	100.00%	100.00%
160	100.00%	100.00%	100.00%	100.00%	100.00%	100.00%	100.00%	99.65%	100.00%	100.00%	98.93%	100.00%	100.00%	100.00%	100.00%
170	100.00%	100.00%	100.00%	100.00%	100.00%	100.00%	100.00%	99.67%	100.00%	100.00%	98.90%	100.00%	100.00%	100.00%	100.00%
180	100.00%	100.00%	100.00%	100.00%	100.00%	100.00%	100.00%	99.71%	100.00%	100.00%	99.03%	100.00%	100.00%	100.00%	100.00%
190	100.00%	100.00%	100.00%	100.00%	100.00%	100.00%	100.00%	99.73%	100.00%	100.00%	99.02%	100.00%	100.00%	100.00%	100.00%
200	100.00%	100.00%	100.00%	100.00%	100.00%	100.00%	100.00%	99.75%	100.00%	100.00%	99.05%	100.00%	100.00%	100.00%	100.00%
210	100.00%	100.00%	100.00%	100.00%	100.00%	100.00%	100.00%	99.78%	100.00%	100.00%	99.06%	100.00%	100.00%	100.00%	100.00%
220	100.00%	100.00%	100.00%	100.00%	100.00%	100.00%	100.00%	99.79%	100.00%	100.00%	99.07%	100.00%	100.00%	100.00%	100.00%
230	100.00%	100.00%	100.00%	100.00%	100.00%	100.00%	100.00%	99.82%	100.00%	100.00%	99.09%	100.00%	100.00%	100.00%	100.00%
240	100.00%	100.00%	100.00%	100.00%	100.00%	100.00%	100.00%	99.83%	100.00%	100.00%	99.10%	100.00%	100.00%	100.00%	100.00%
250	100.00%	100.00%	100.00%	100.00%	100.00%	100.00%	100.00%	99.83%	100.00%	100.00%	99.11%	100.00%	100.00%	100.00%	100.00%

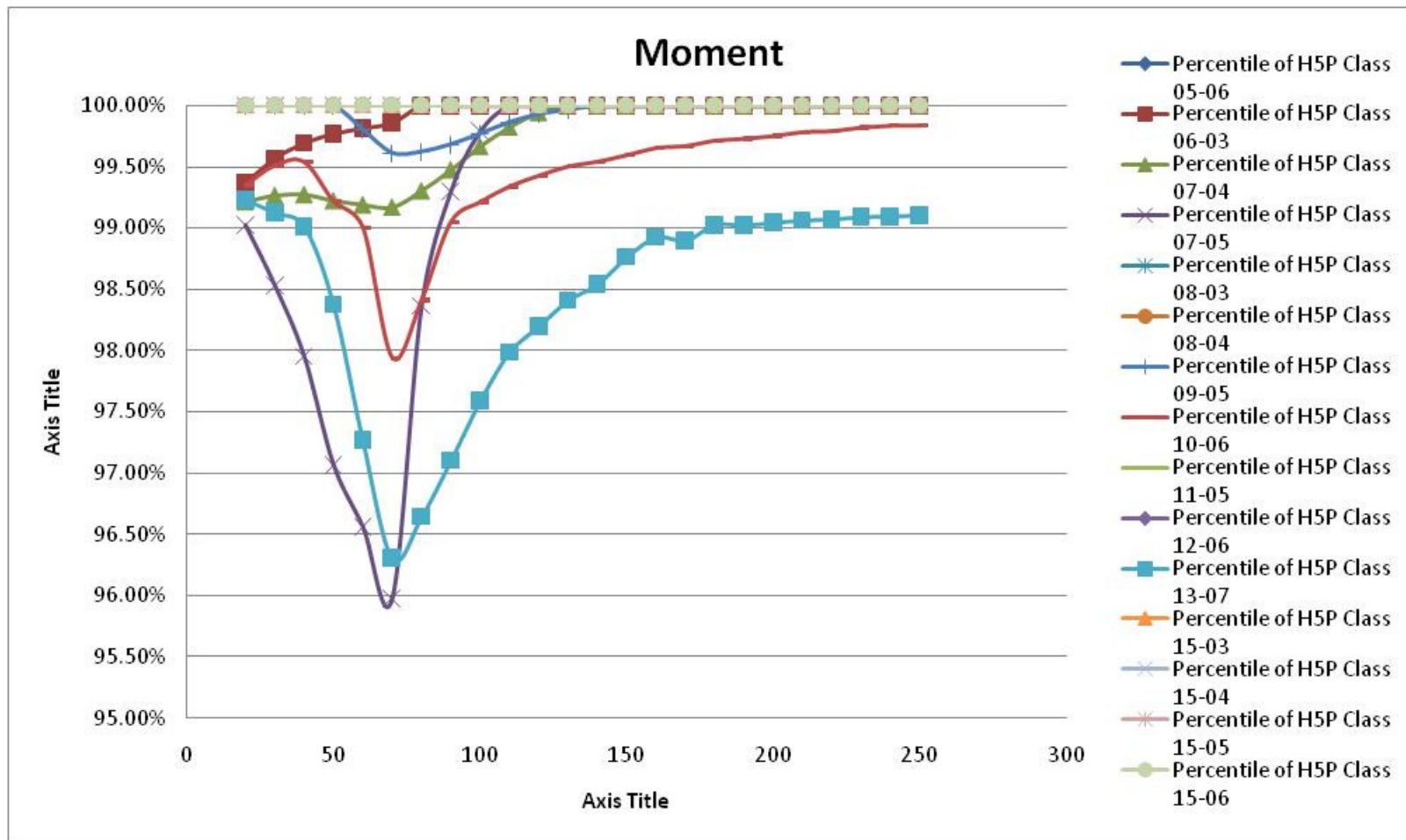

Moment	Percentile of Total														
	Class 05-06	Class 06-03	Class 07-04	Class 07-05	Class 08-03	Class 08-04	Class 09-05	Class 10-06	Class 11-05	Class 12-06	Class 13-07	Class 15-03	Class 15-04	Class 15-05	Class 15-06
20	100.00%	99.97%	99.96%	99.95%	100.00%	100.00%	100.00%	99.97%	100.00%	100.00%	99.96%	100.00%	100.00%	100.00%	100.00%
30	100.00%	99.98%	99.96%	99.93%	100.00%	100.00%	100.00%	99.98%	100.00%	100.00%	99.96%	100.00%	100.00%	100.00%	100.00%
40	100.00%	99.98%	99.96%	99.90%	100.00%	100.00%	100.00%	99.98%	100.00%	100.00%	99.95%	100.00%	100.00%	100.00%	100.00%
50	100.00%	99.99%	99.96%	99.85%	100.00%	100.00%	100.00%	99.96%	100.00%	100.00%	99.92%	100.00%	100.00%	100.00%	100.00%
60	100.00%	99.99%	99.96%	99.83%	100.00%	100.00%	99.99%	99.95%	100.00%	100.00%	99.86%	100.00%	100.00%	100.00%	100.00%
70	100.00%	99.99%	99.96%	99.80%	100.00%	100.00%	99.98%	99.90%	100.00%	100.00%	99.82%	100.00%	100.00%	100.00%	100.00%
80	100.00%	100.00%	99.97%	99.92%	100.00%	100.00%	99.98%	99.92%	100.00%	100.00%	99.83%	100.00%	100.00%	100.00%	100.00%
90	100.00%	100.00%	99.97%	99.97%	100.00%	100.00%	99.98%	99.95%	100.00%	100.00%	99.86%	100.00%	100.00%	100.00%	100.00%
100	100.00%	100.00%	99.98%	99.99%	100.00%	100.00%	99.99%	99.96%	100.00%	100.00%	99.88%	100.00%	100.00%	100.00%	100.00%
110	100.00%	100.00%	99.99%	100.00%	100.00%	100.00%	99.99%	99.97%	100.00%	100.00%	99.90%	100.00%	100.00%	100.00%	100.00%
120	100.00%	100.00%	100.00%	100.00%	100.00%	100.00%	100.00%	99.97%	100.00%	100.00%	99.91%	100.00%	100.00%	100.00%	100.00%
130	100.00%	100.00%	100.00%	100.00%	100.00%	100.00%	100.00%	99.97%	100.00%	100.00%	99.92%	100.00%	100.00%	100.00%	100.00%
140	100.00%	100.00%	100.00%	100.00%	100.00%	100.00%	100.00%	99.98%	100.00%	100.00%	99.93%	100.00%	100.00%	100.00%	100.00%
150	100.00%	100.00%	100.00%	100.00%	100.00%	100.00%	100.00%	99.98%	100.00%	100.00%	99.94%	100.00%	100.00%	100.00%	100.00%
160	100.00%	100.00%	100.00%	100.00%	100.00%	100.00%	100.00%	99.98%	100.00%	100.00%	99.95%	100.00%	100.00%	100.00%	100.00%
170	100.00%	100.00%	100.00%	100.00%	100.00%	100.00%	100.00%	99.98%	100.00%	100.00%	99.94%	100.00%	100.00%	100.00%	100.00%
180	100.00%	100.00%	100.00%	100.00%	100.00%	100.00%	100.00%	99.99%	100.00%	100.00%	99.95%	100.00%	100.00%	100.00%	100.00%
190	100.00%	100.00%	100.00%	100.00%	100.00%	100.00%	100.00%	99.99%	100.00%	100.00%	99.95%	100.00%	100.00%	100.00%	100.00%
200	100.00%	100.00%	100.00%	100.00%	100.00%	100.00%	100.00%	99.99%	100.00%	100.00%	99.95%	100.00%	100.00%	100.00%	100.00%
210	100.00%	100.00%	100.00%	100.00%	100.00%	100.00%	100.00%	99.99%	100.00%	100.00%	99.95%	100.00%	100.00%	100.00%	100.00%
220	100.00%	100.00%	100.00%	100.00%	100.00%	100.00%	100.00%	99.99%	100.00%	100.00%	99.95%	100.00%	100.00%	100.00%	100.00%
230	100.00%	100.00%	100.00%	100.00%	100.00%	100.00%	100.00%	99.99%	100.00%	100.00%	99.95%	100.00%	100.00%	100.00%	100.00%
240	100.00%	100.00%	100.00%	100.00%	100.00%	100.00%	100.00%	99.99%	100.00%	100.00%	99.95%	100.00%	100.00%	100.00%	100.00%
250	100.00%	100.00%	100.00%	100.00%	100.00%	100.00%	100.00%	99.99%	100.00%	100.00%	99.96%	100.00%	100.00%	100.00%	100.00%

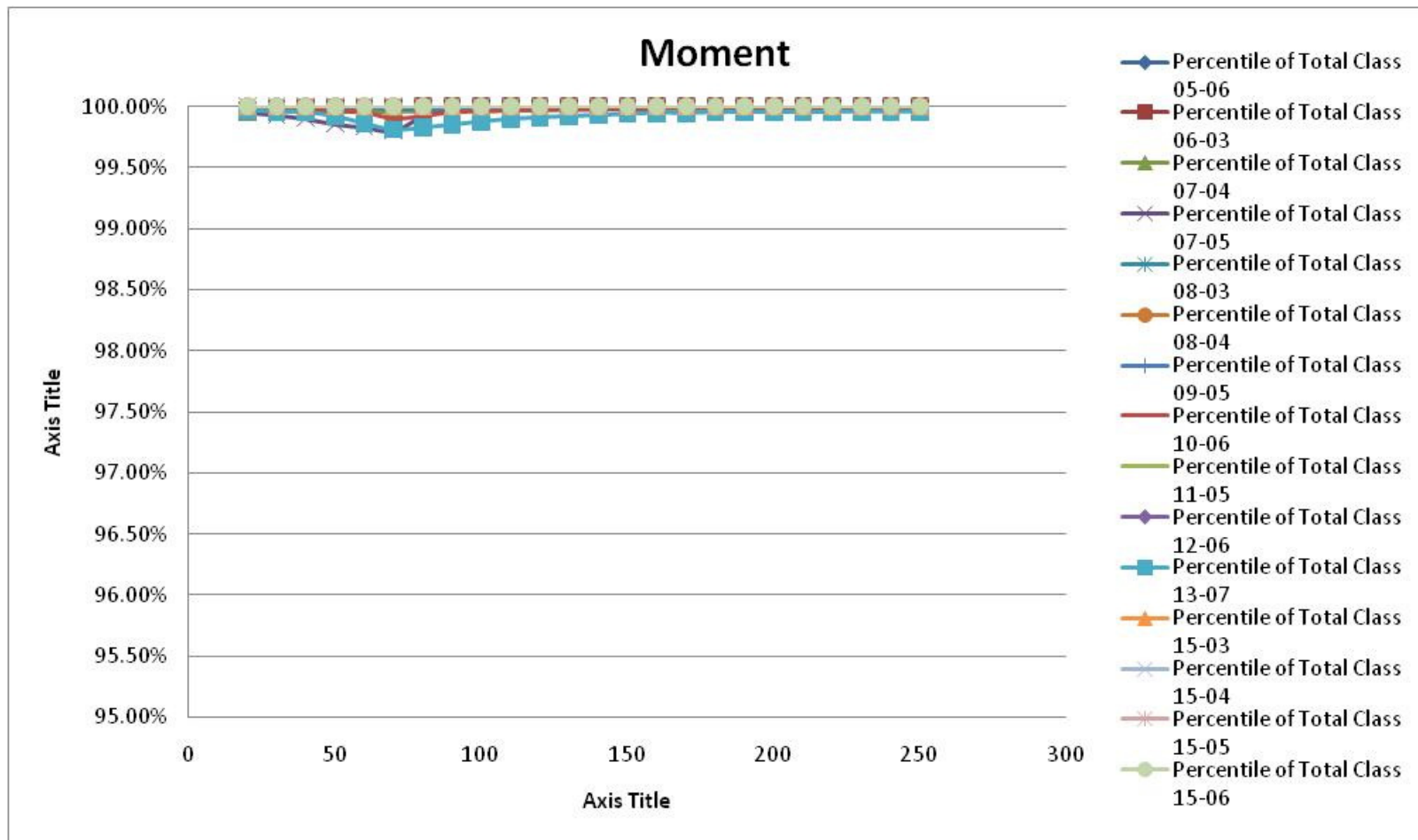

Shear	Percentile of H5P														
	Class 05-06	Class 06-03	Class 07-04	Class 07-05	Class 08-03	Class 08-04	Class 09-05	Class 10-06	Class 11-05	Class 12-06	Class 13-07	Class 15-03	Class 15-04	Class 15-05	Class 15-06
20	100.00%	99.45%	99.12%	98.03%	100.00%	100.00%	100.00%	99.29%	100.00%	100.00%	99.01%	100.00%	100.00%	100.00%	100.00%
30	100.00%	99.68%	99.20%	97.84%	100.00%	100.00%	100.00%	99.27%	100.00%	100.00%	99.01%	100.00%	100.00%	100.00%	100.00%
40	100.00%	99.79%	99.16%	96.60%	100.00%	100.00%	100.00%	98.74%	100.00%	100.00%	98.08%	100.00%	100.00%	100.00%	100.00%
50	100.00%	99.96%	99.21%	97.24%	100.00%	100.00%	99.73%	97.75%	100.00%	100.00%	97.20%	100.00%	100.00%	100.00%	100.00%
60	100.00%	100.00%	99.51%	99.53%	100.00%	100.00%	99.87%	99.10%	100.00%	100.00%	98.45%	100.00%	100.00%	100.00%	100.00%
70	100.00%	100.00%	99.76%	100.00%	100.00%	100.00%	99.96%	99.29%	100.00%	100.00%	99.02%	100.00%	100.00%	100.00%	100.00%
80	100.00%	100.00%	99.94%	100.00%	100.00%	100.00%	100.00%	99.41%	100.00%	100.00%	99.11%	100.00%	100.00%	100.00%	100.00%
90	100.00%	100.00%	100.00%	100.00%	100.00%	100.00%	100.00%	99.49%	100.00%	100.00%	99.10%	100.00%	100.00%	100.00%	100.00%
100	100.00%	100.00%	100.00%	100.00%	100.00%	100.00%	100.00%	99.59%	100.00%	100.00%	99.18%	100.00%	100.00%	100.00%	100.00%
110	100.00%	100.00%	100.00%	100.00%	100.00%	100.00%	100.00%	99.65%	100.00%	100.00%	99.20%	100.00%	100.00%	100.00%	100.00%
120	100.00%	100.00%	100.00%	100.00%	100.00%	100.00%	100.00%	99.72%	100.00%	100.00%	99.22%	100.00%	100.00%	100.00%	100.00%
130	100.00%	100.00%	100.00%	100.00%	100.00%	100.00%	100.00%	99.77%	100.00%	100.00%	99.25%	100.00%	100.00%	100.00%	100.00%
140	100.00%	100.00%	100.00%	100.00%	100.00%	100.00%	100.00%	99.81%	100.00%	100.00%	99.28%	100.00%	100.00%	100.00%	100.00%
150	100.00%	100.00%	100.00%	100.00%	100.00%	100.00%	100.00%	99.83%	100.00%	100.00%	99.26%	100.00%	100.00%	100.00%	100.00%
160	100.00%	100.00%	100.00%	100.00%	100.00%	100.00%	100.00%	99.83%	100.00%	100.00%	99.24%	100.00%	100.00%	100.00%	100.00%
170	100.00%	100.00%	100.00%	100.00%	100.00%	100.00%	100.00%	99.85%	100.00%	100.00%	99.22%	100.00%	100.00%	100.00%	100.00%
180	100.00%	100.00%	100.00%	100.00%	100.00%	100.00%	100.00%	99.86%	100.00%	100.00%	99.22%	100.00%	100.00%	100.00%	100.00%
190	100.00%	100.00%	100.00%	100.00%	100.00%	100.00%	100.00%	99.89%	100.00%	100.00%	99.22%	100.00%	100.00%	100.00%	100.00%
200	100.00%	100.00%	100.00%	100.00%	100.00%	100.00%	100.00%	99.92%	100.00%	100.00%	99.24%	100.00%	100.00%	100.00%	100.00%
210	100.00%	100.00%	100.00%	100.00%	100.00%	100.00%	100.00%	99.97%	100.00%	100.00%	99.29%	100.00%	100.00%	100.00%	100.00%
220	100.00%	100.00%	100.00%	100.00%	100.00%	100.00%	100.00%	99.96%	100.00%	100.00%	99.26%	100.00%	100.00%	100.00%	100.00%
230	100.00%	100.00%	100.00%	100.00%	100.00%	100.00%	100.00%	99.97%	100.00%	100.00%	99.23%	100.00%	100.00%	100.00%	100.00%
240	100.00%	100.00%	100.00%	100.00%	100.00%	100.00%	100.00%	99.97%	100.00%	100.00%	99.23%	100.00%	100.00%	100.00%	100.00%
250	100.00%	100.00%	100.00%	100.00%	100.00%	100.00%	100.00%	99.96%	100.00%	100.00%	99.24%	100.00%	100.00%	100.00%	100.00%

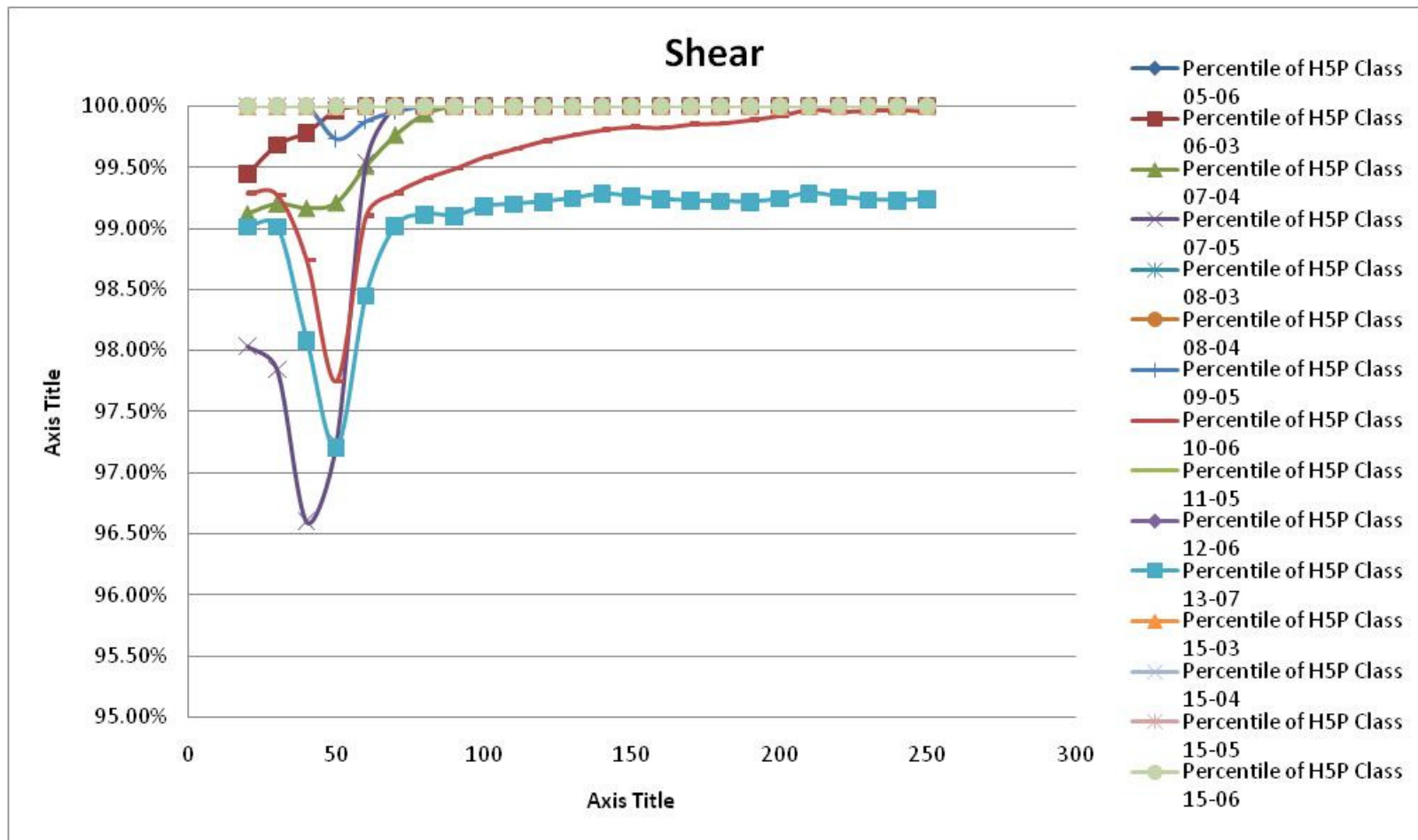

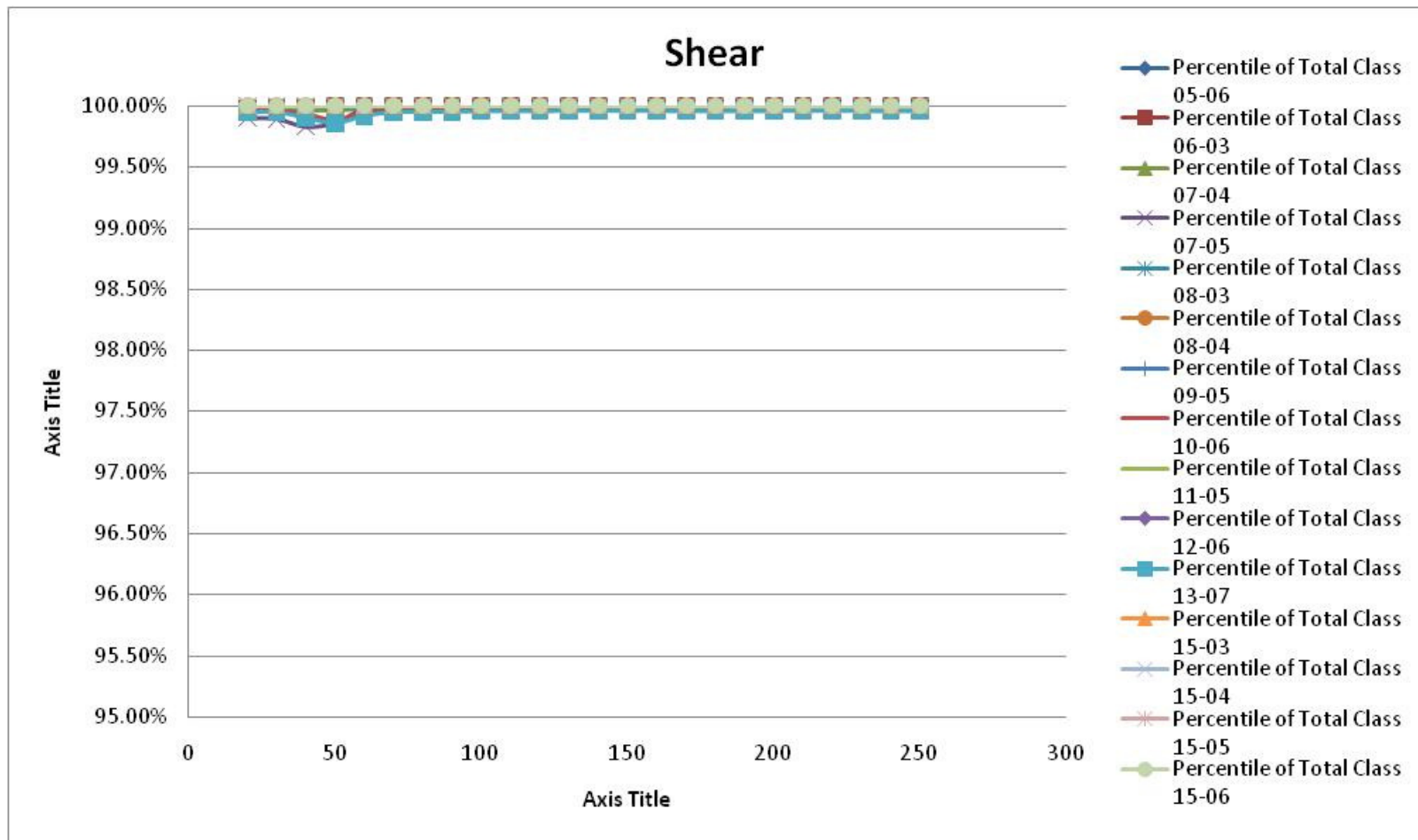

APPENDIX E – SIMULATION RESULTS & ACTUAL DATA

Class 05-02

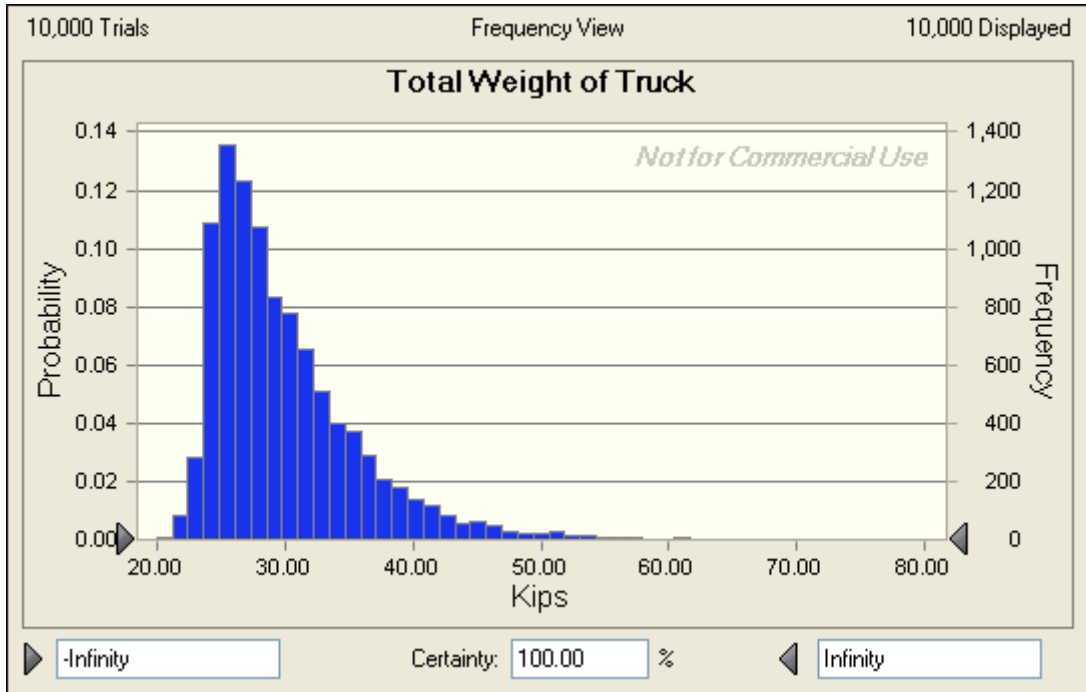

Class 05-02

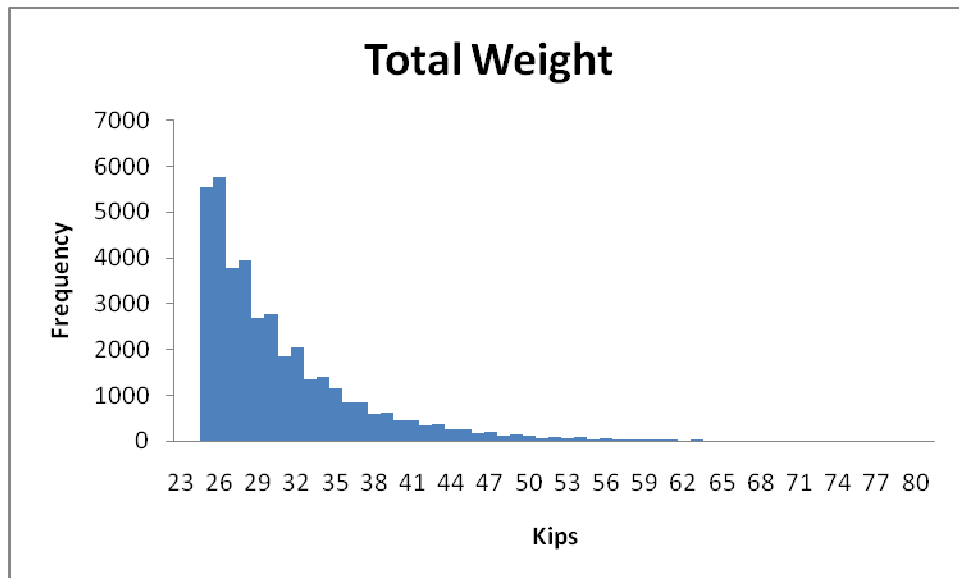

Class 06-03

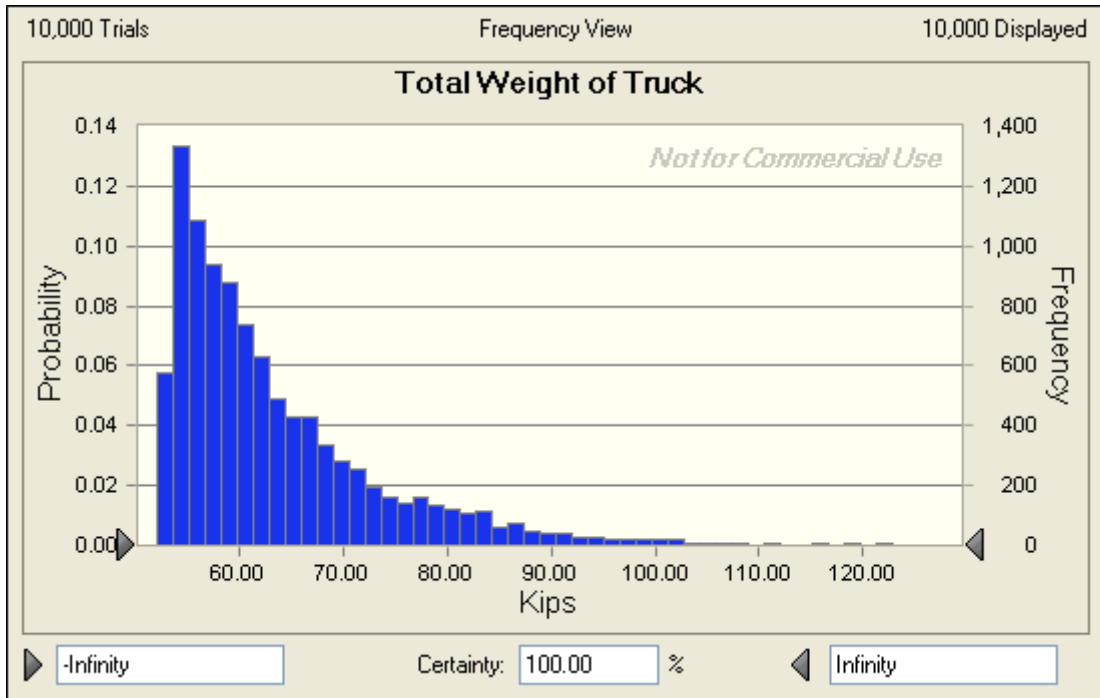

Class 06-03

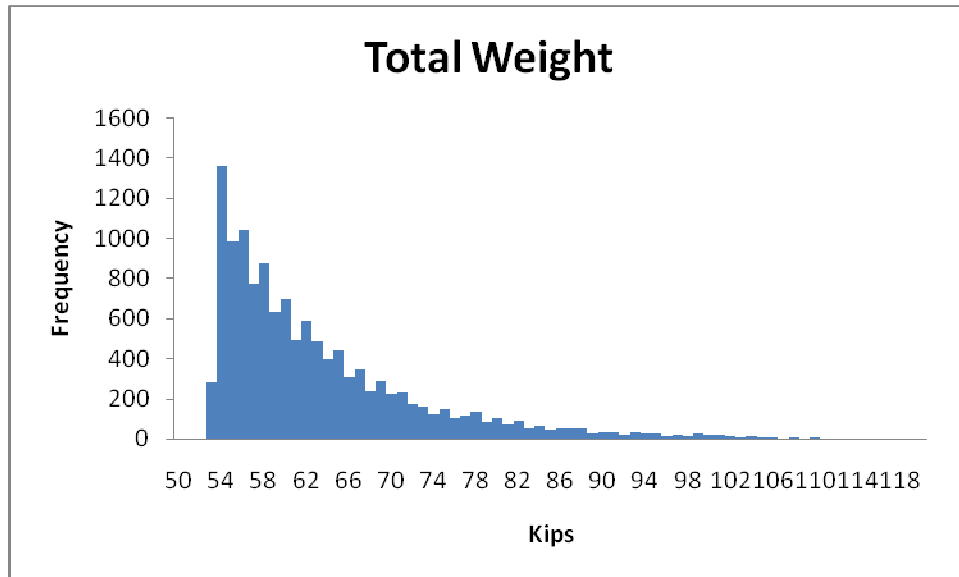

Class 07-04

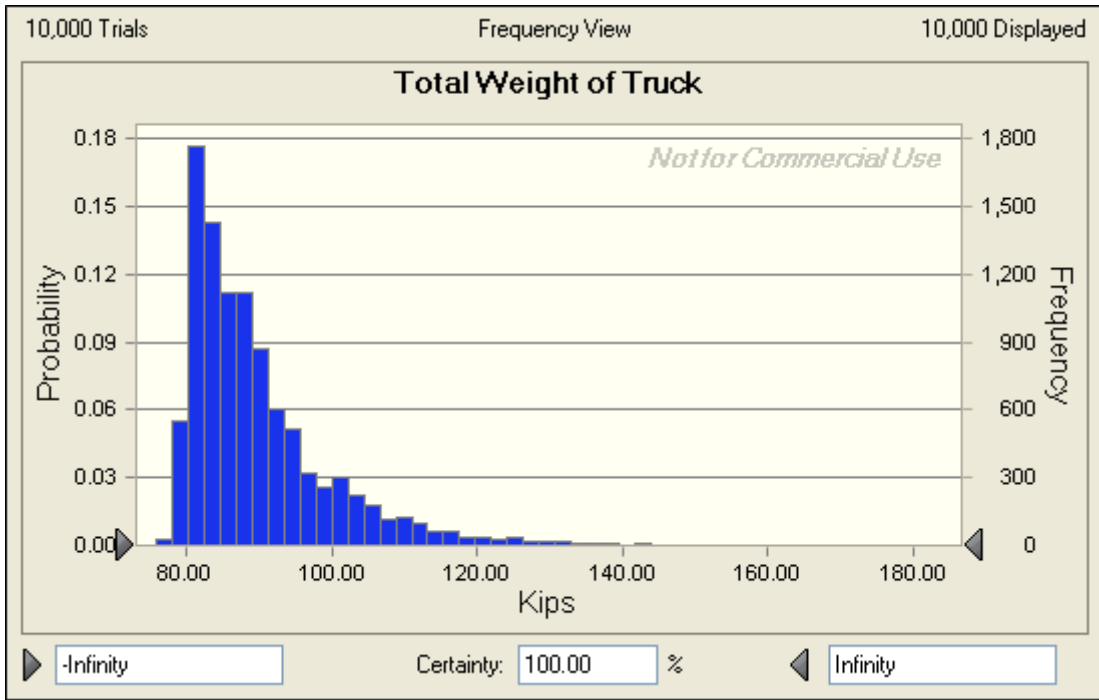

Class 07-04

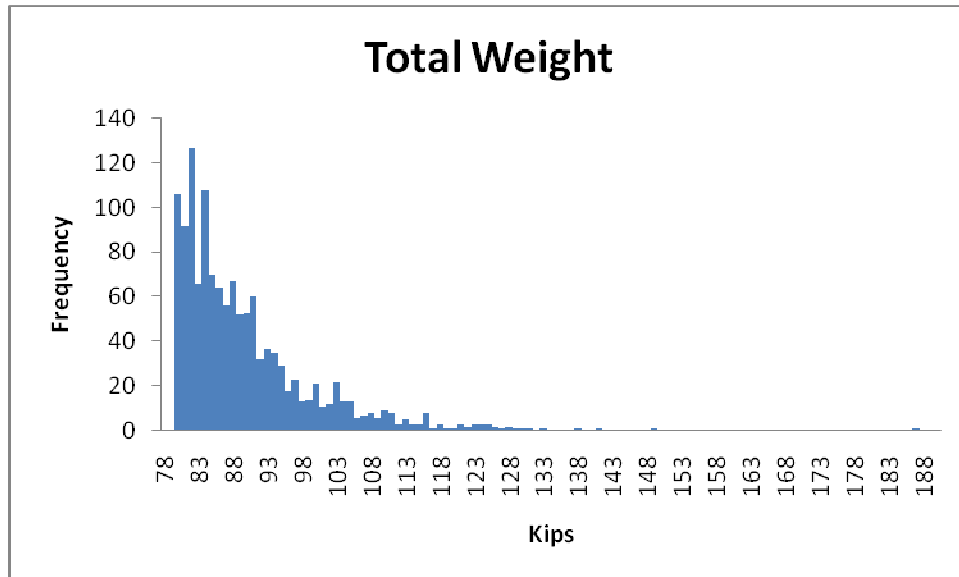

Class 07-05

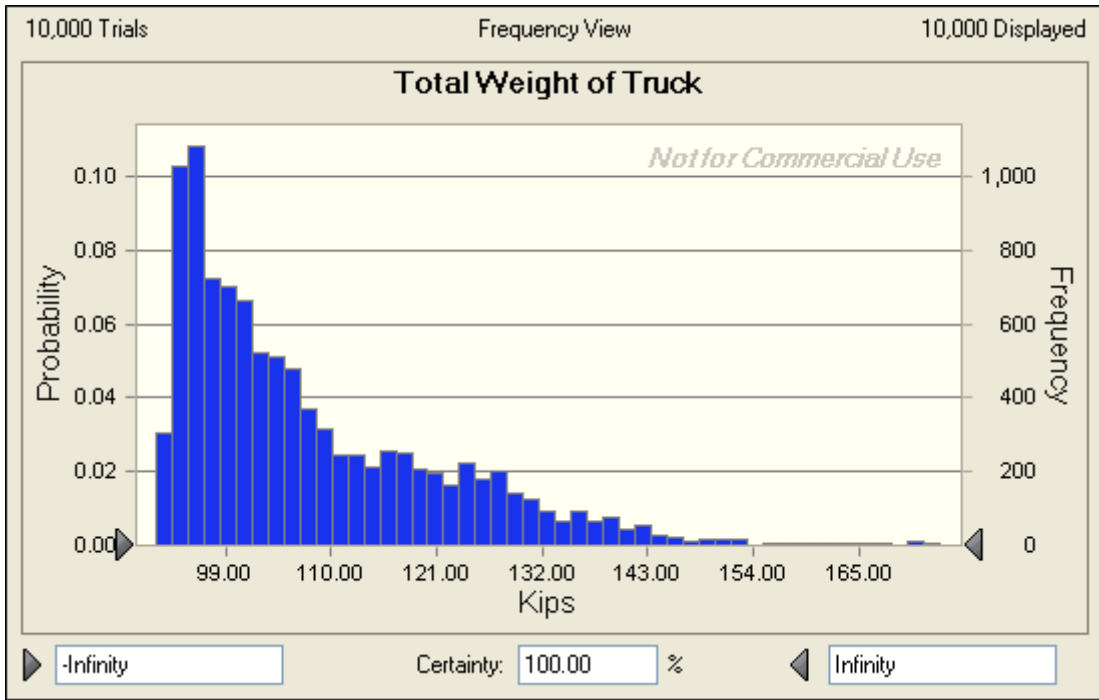

Class 07-05

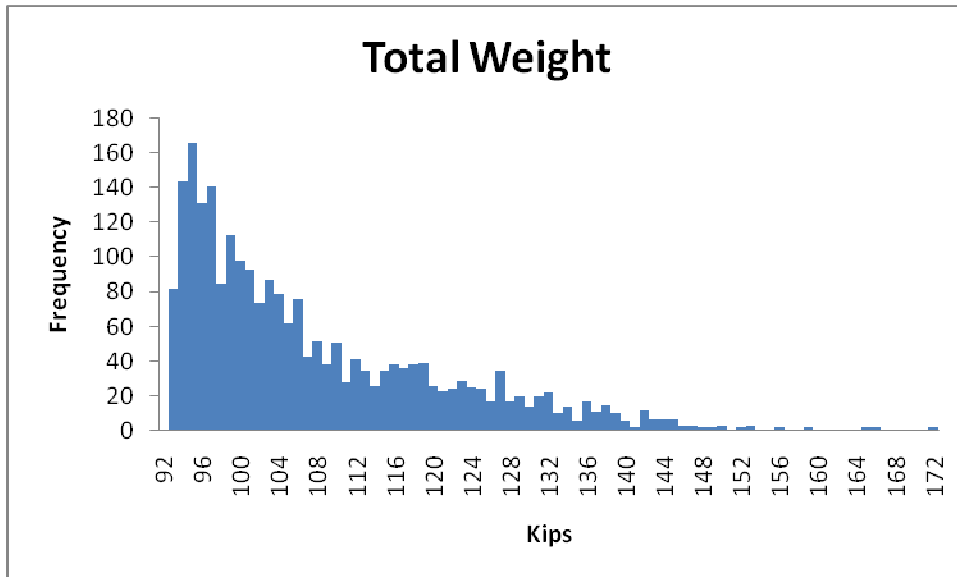

Class 08-03

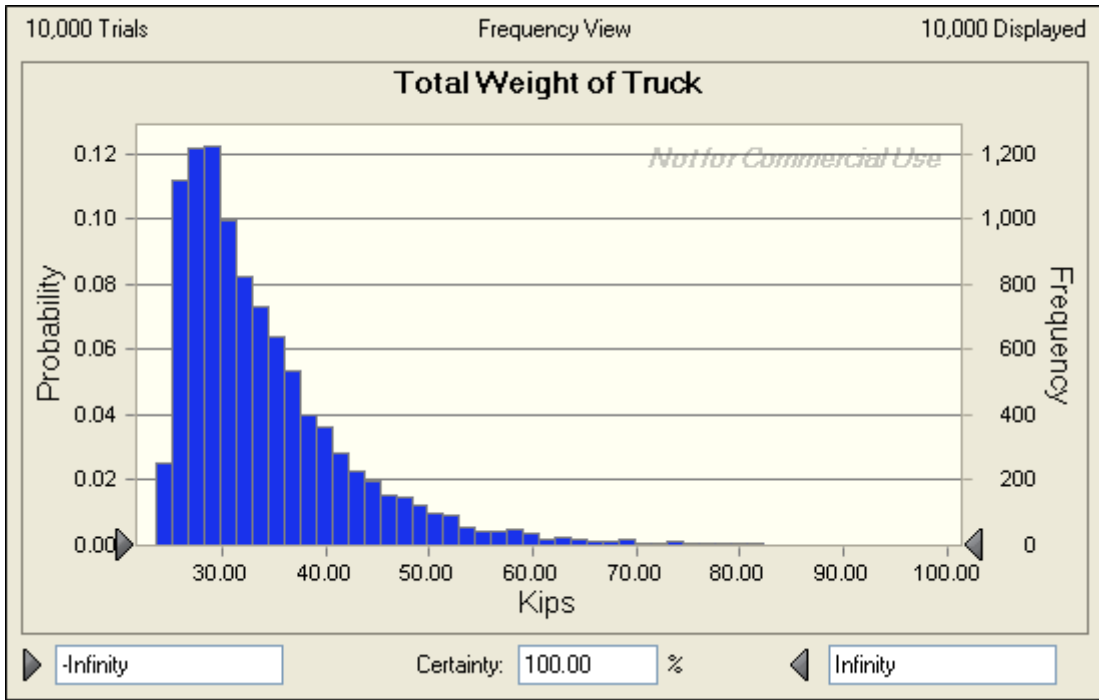

Class 08-03

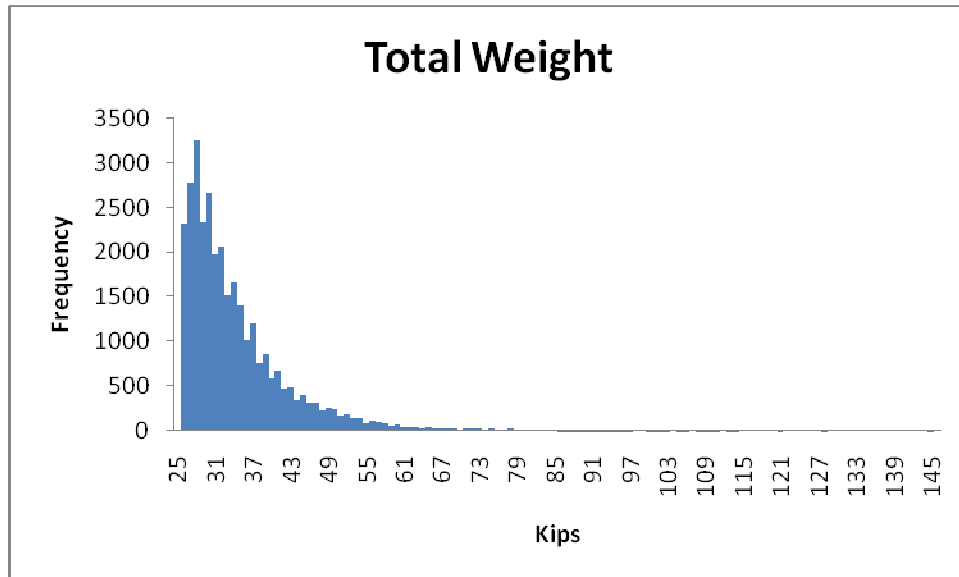

Class 08-04

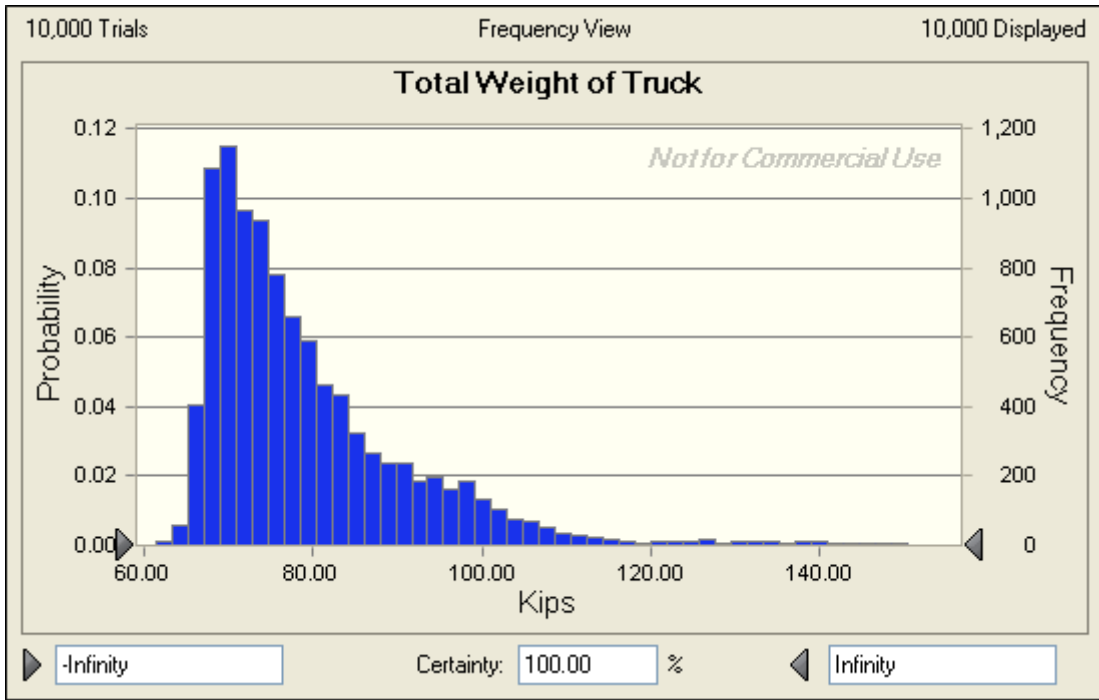

Class 08-04

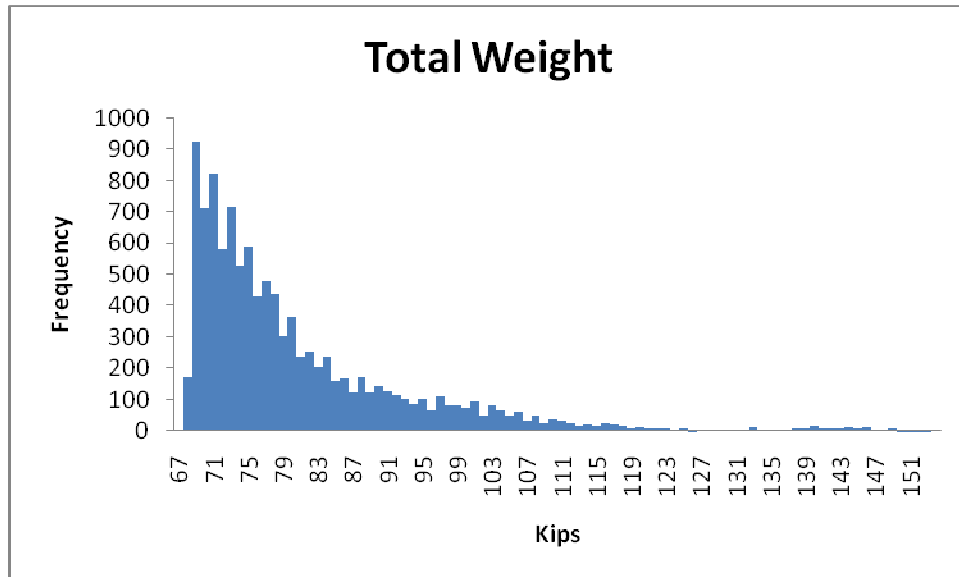

Class 09-05

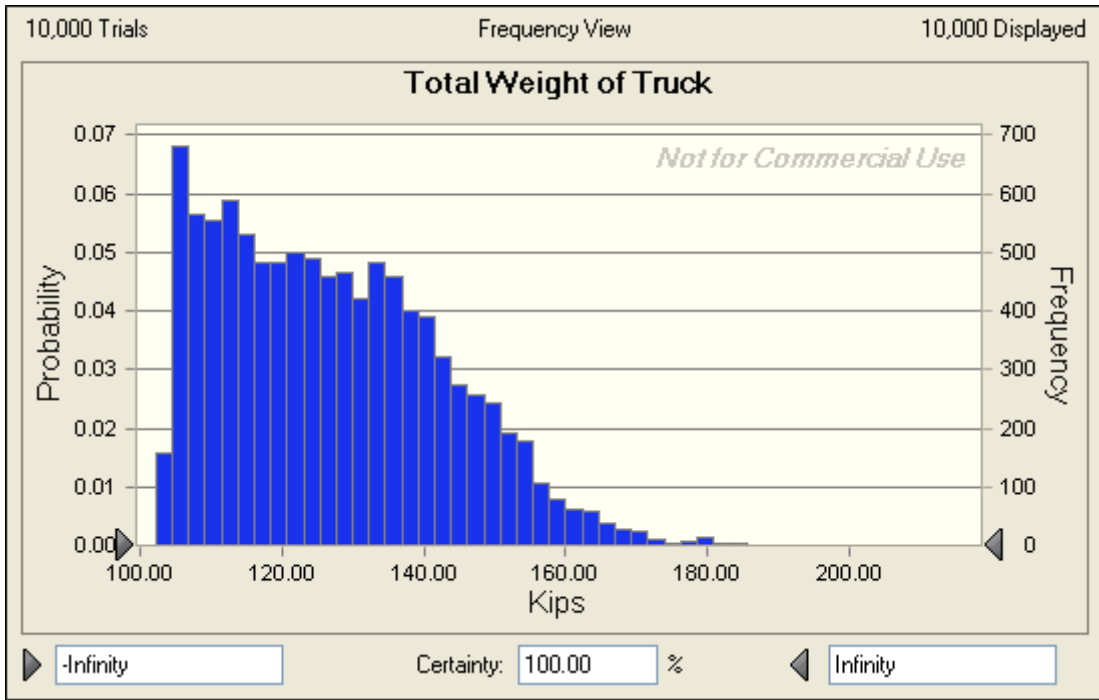

Class 09-05

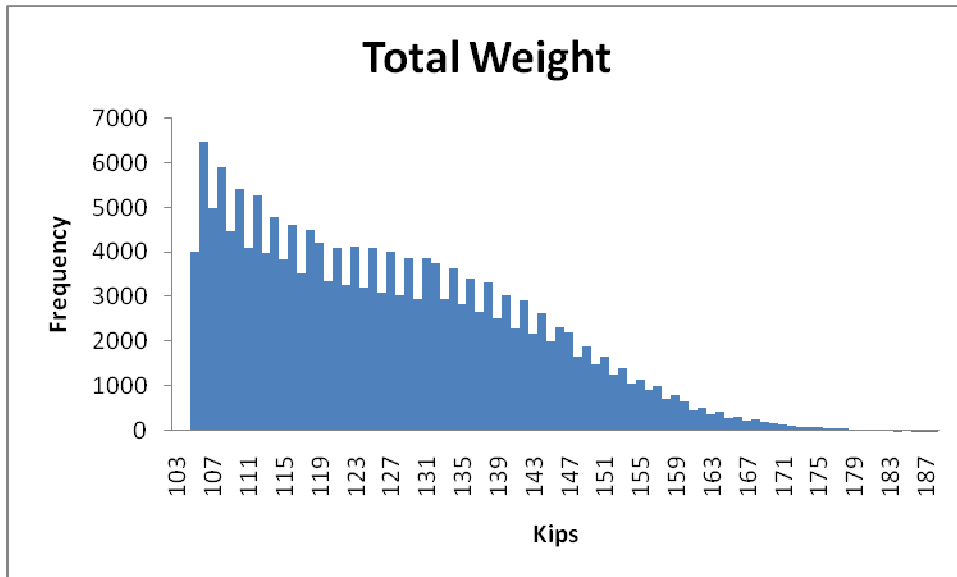

Class 10-06

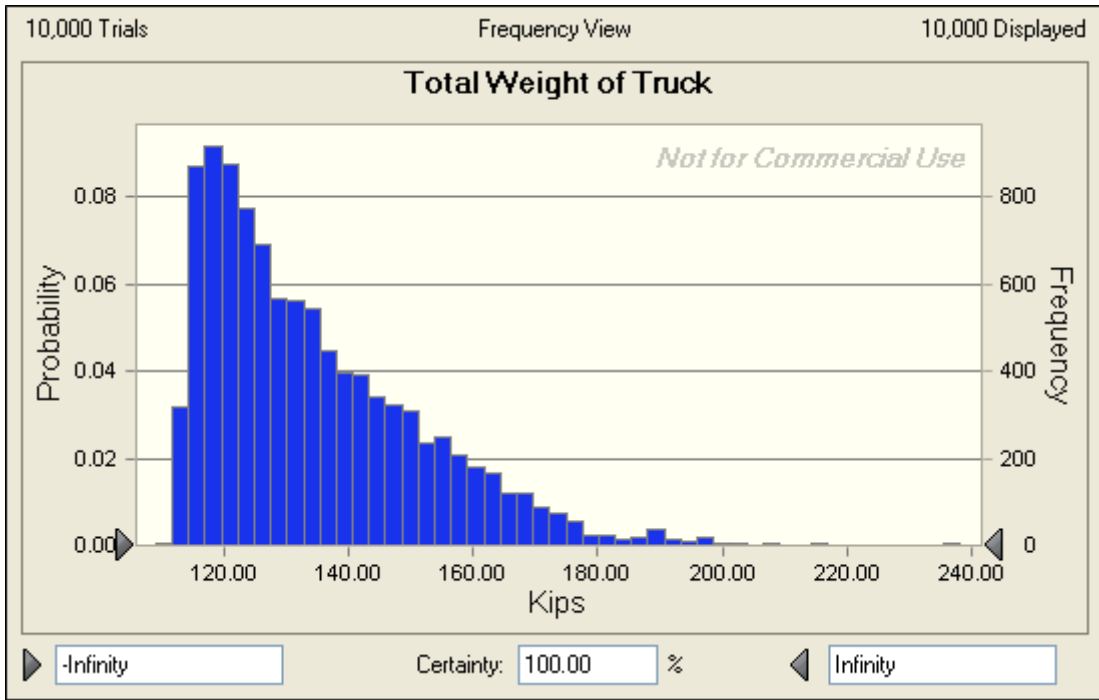

Class 10-06

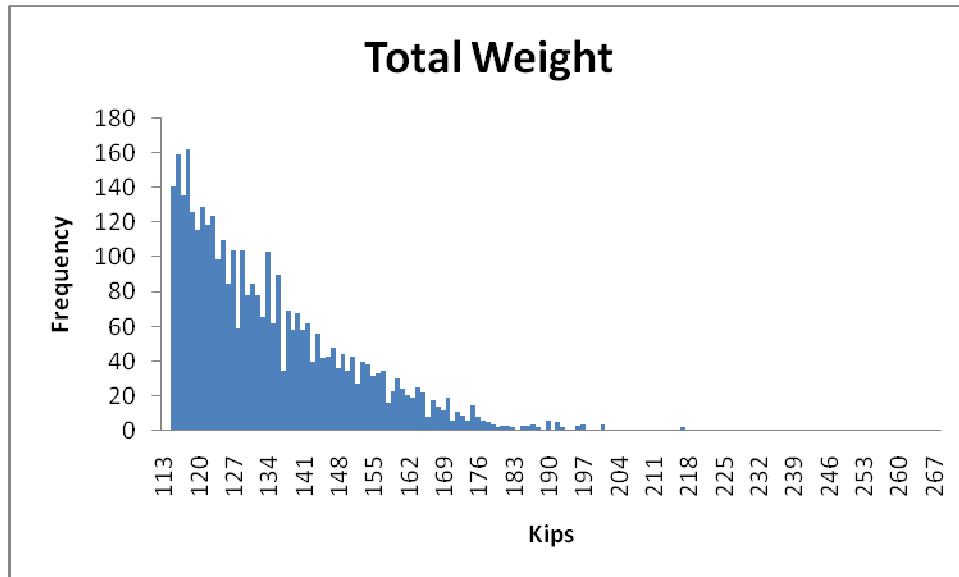

Class 11-05

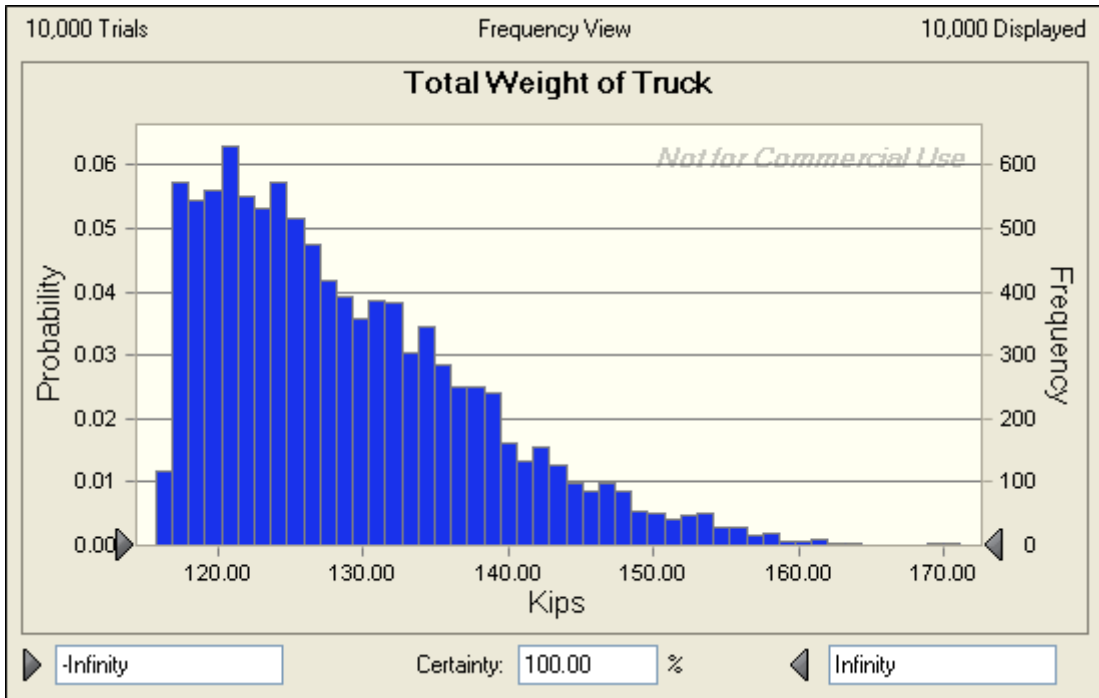

Class 11-05

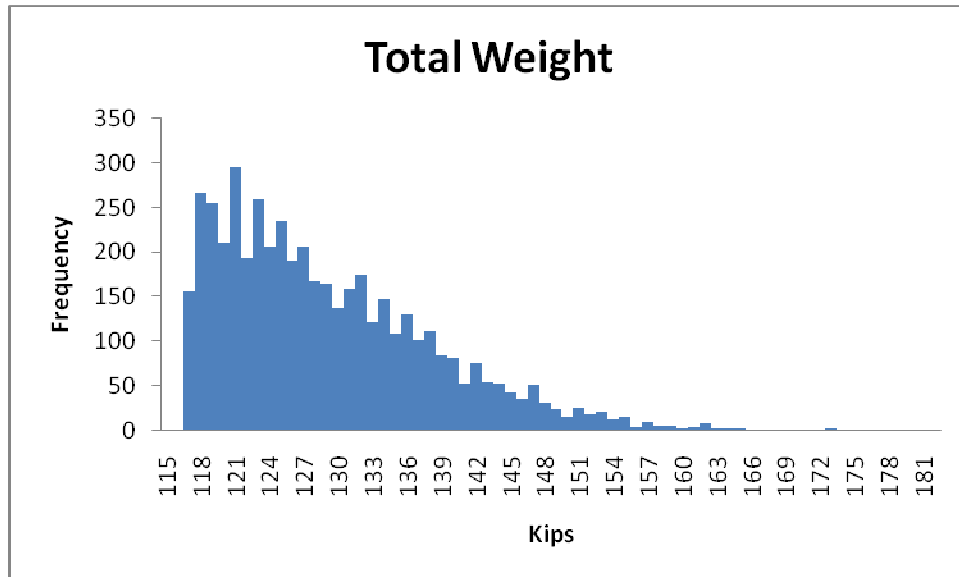

Class 12-06

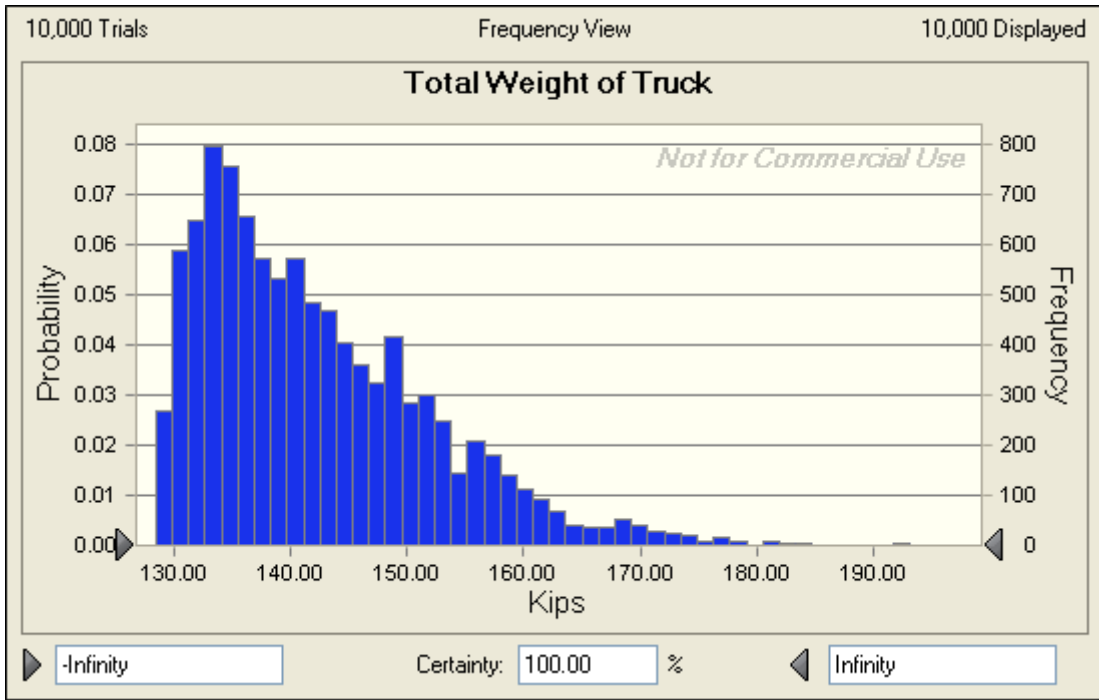

Class12-06

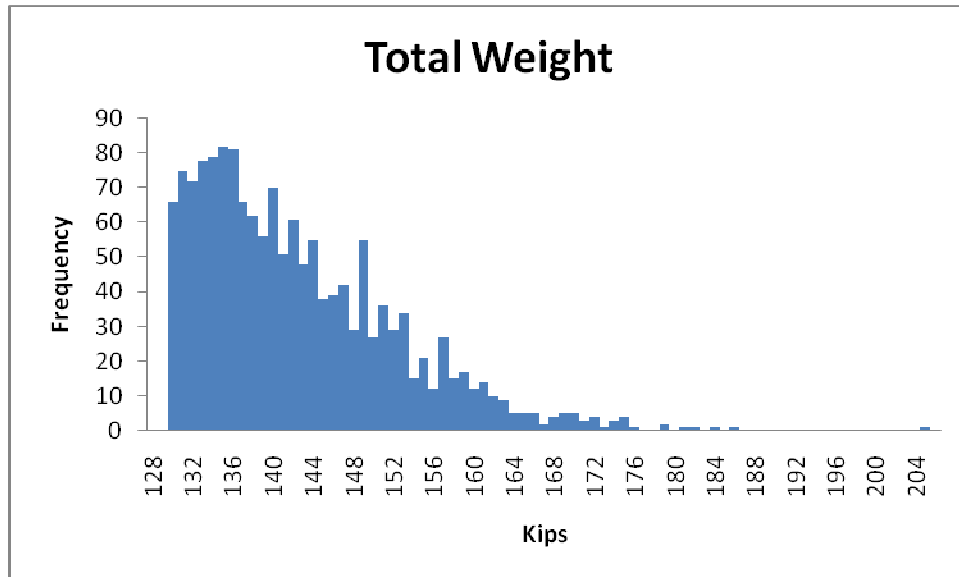

Class 13-07

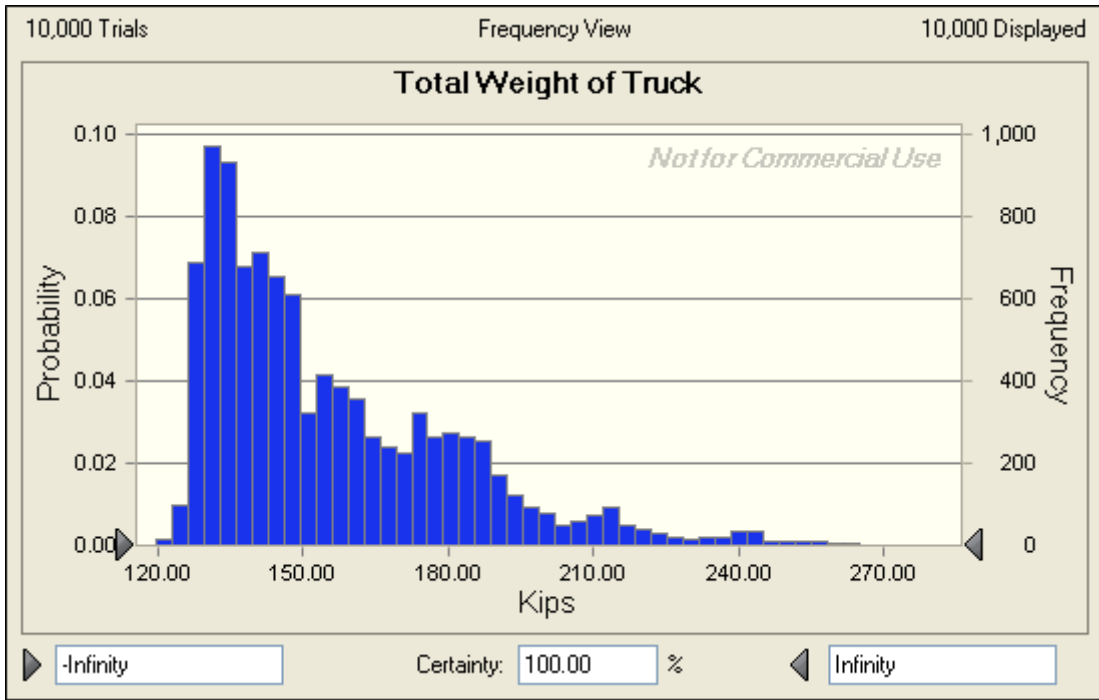

Class 13-07

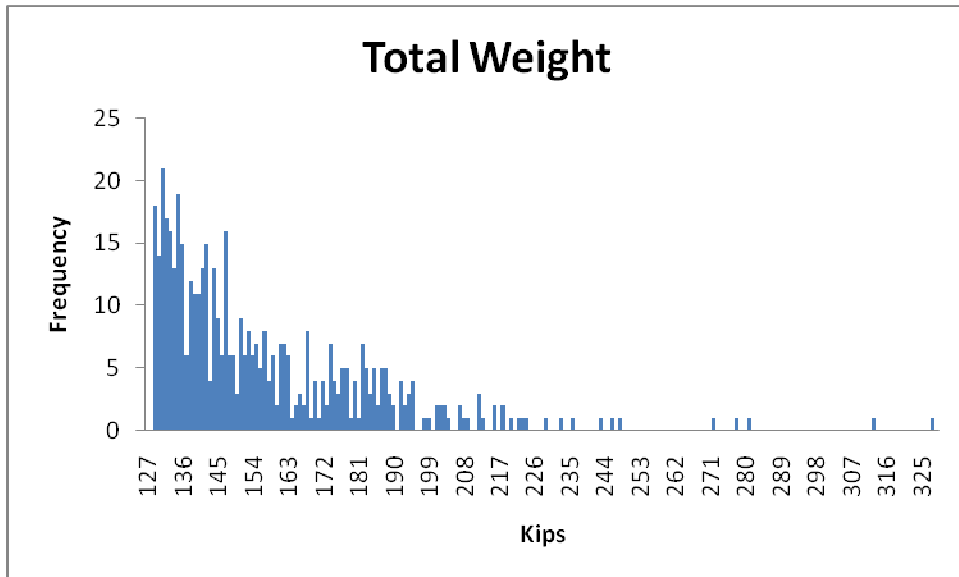

Class 15-03

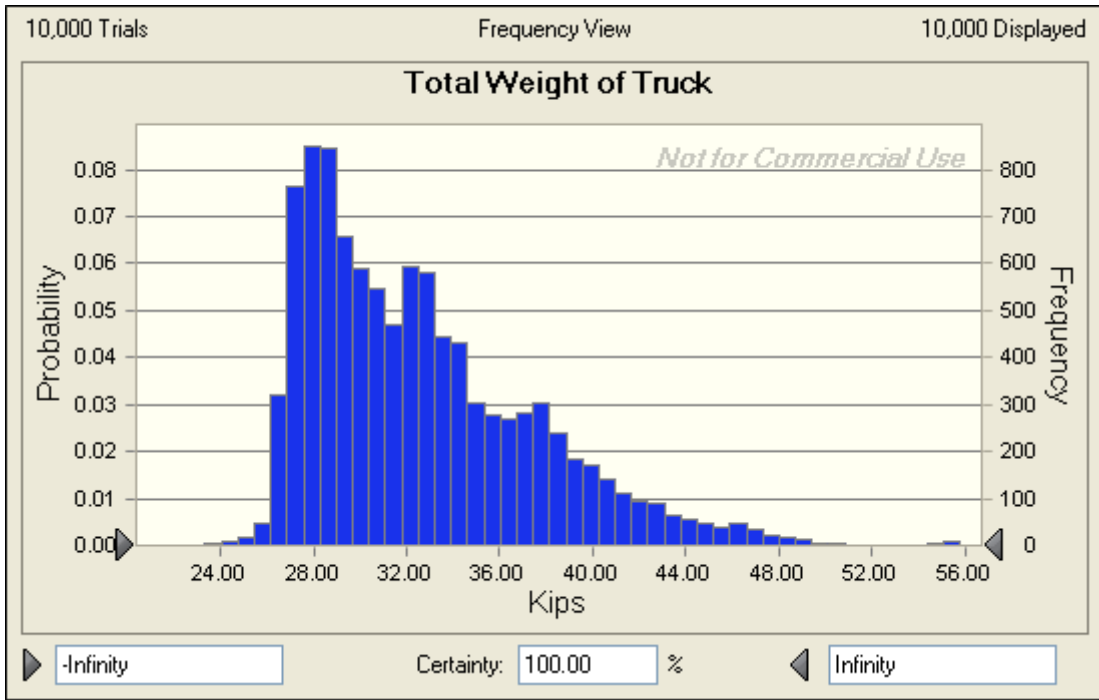

Class 15-03

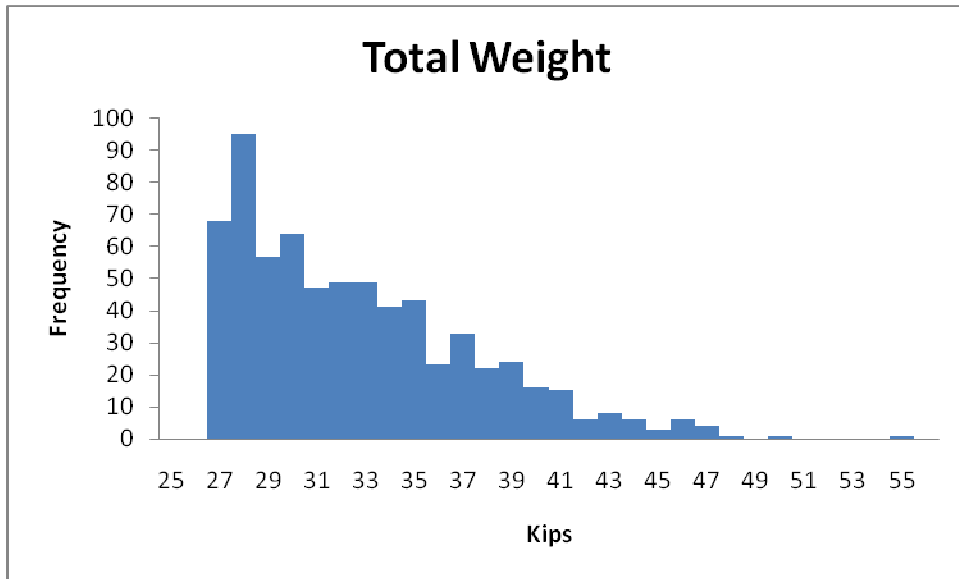

Class 15-04

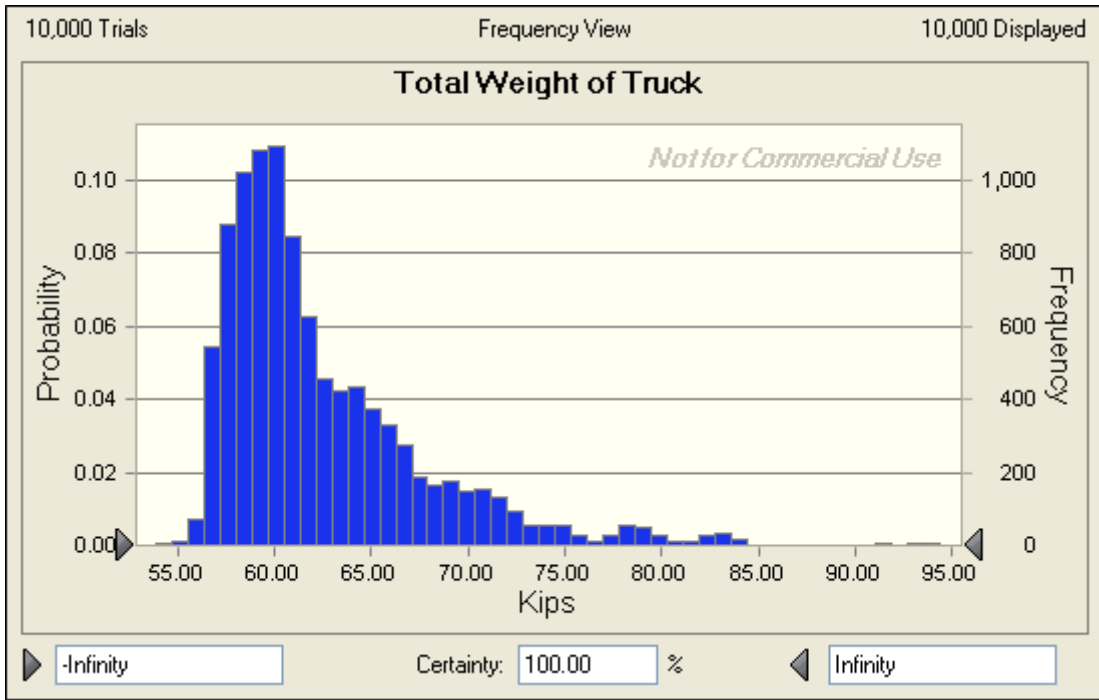

Class 15-04

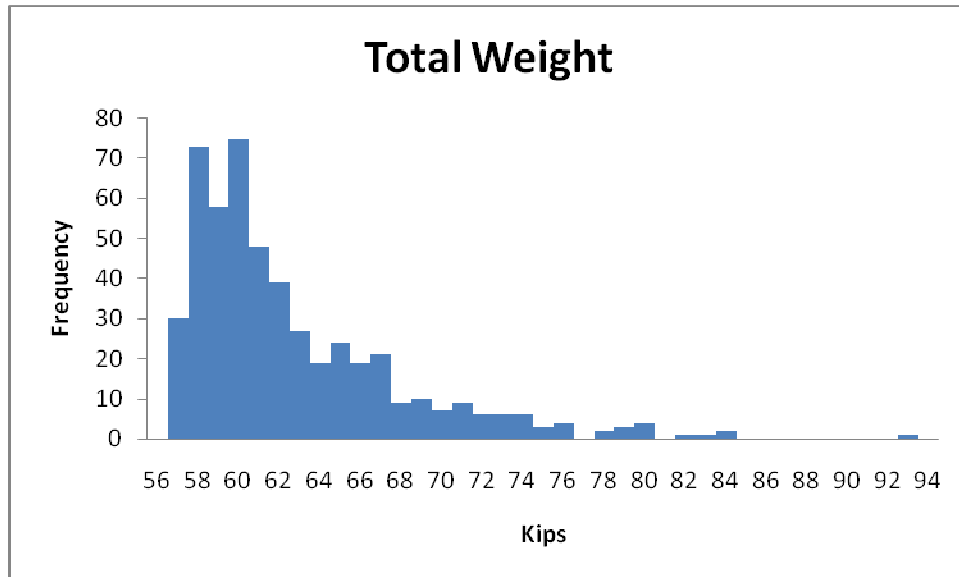

Class 15-05

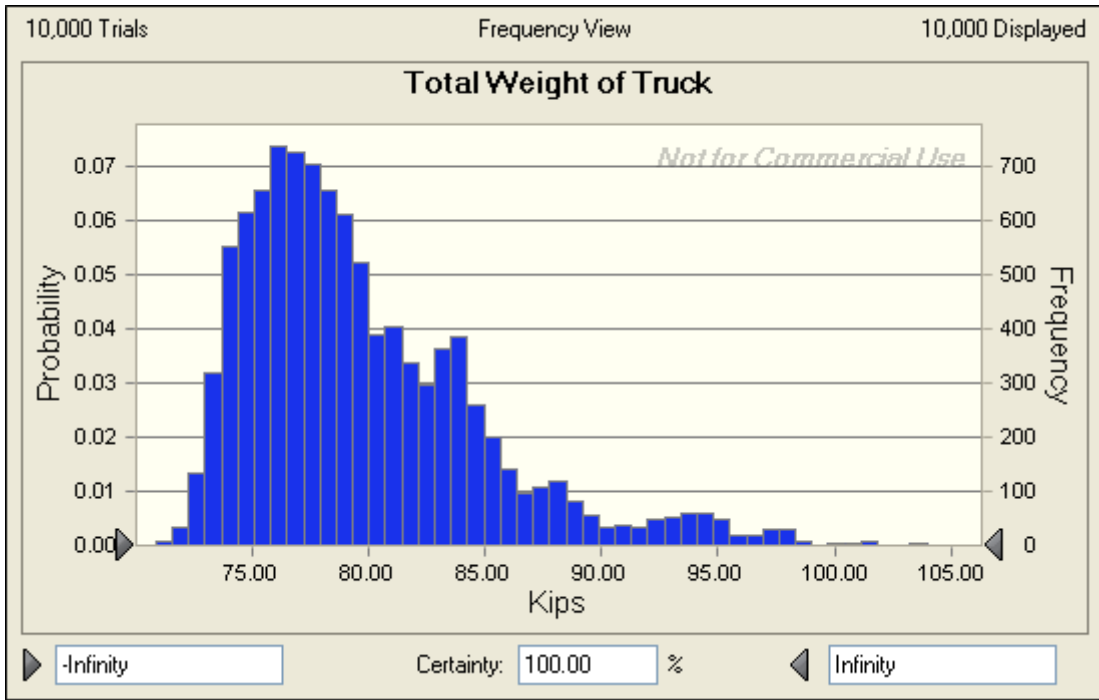

Class 15-05

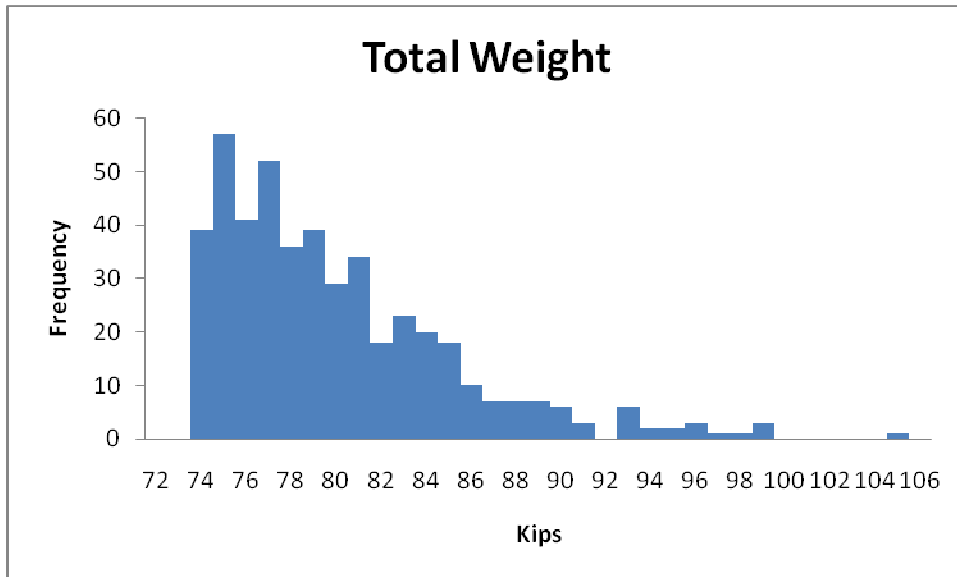

Class 15-06

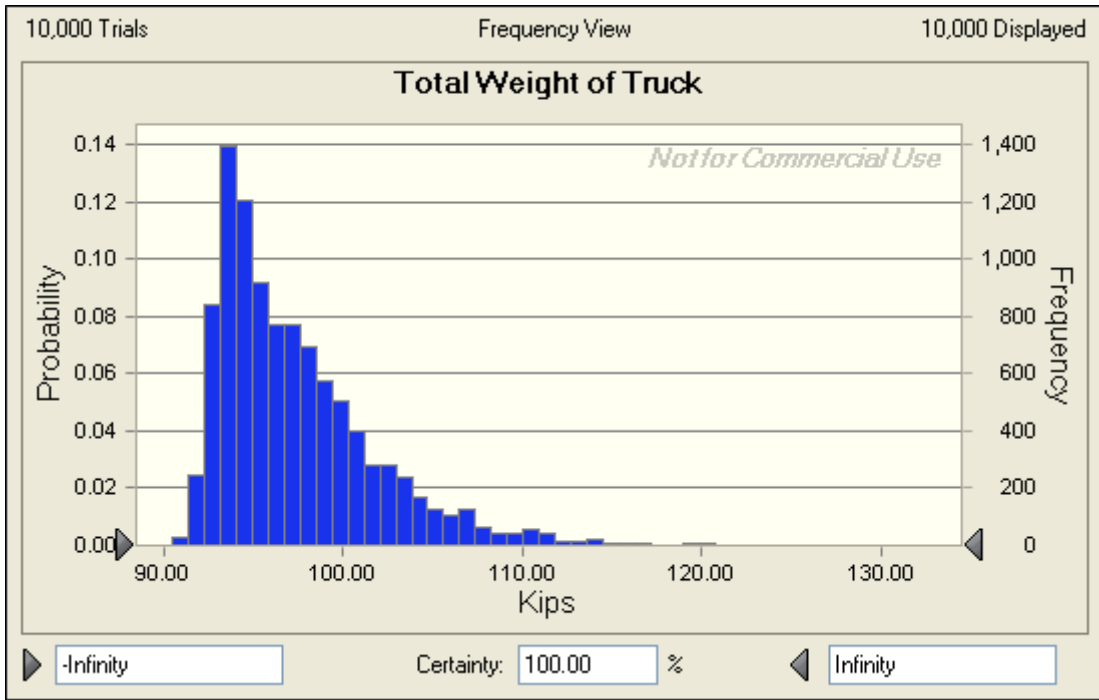

Class 15-06

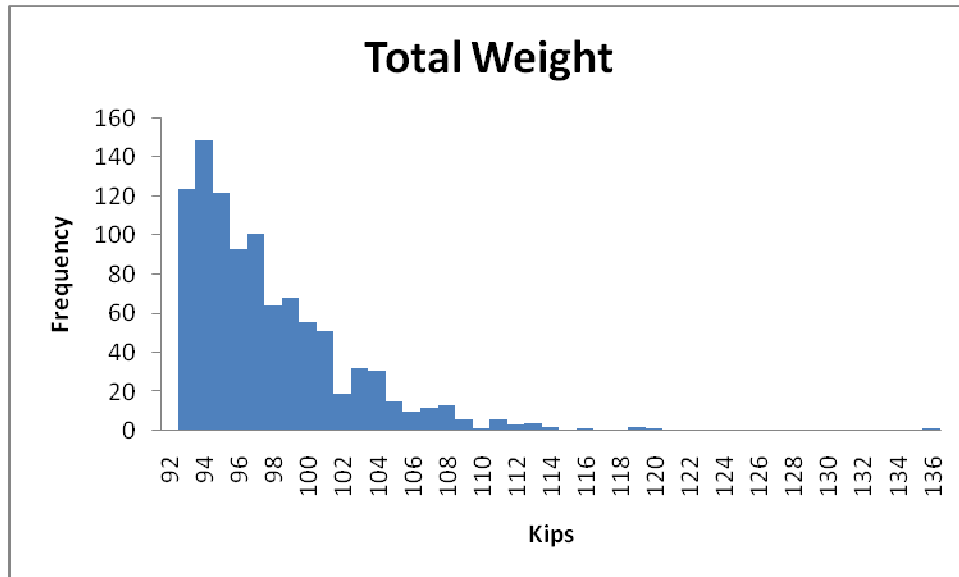

APPENDIX F - DESCRIPTIVE ANALYSIS OF WISCONSIN WIM DATA ⁽⁹⁾

Introduction

Overweight loads, especially those with multi-trip permits, can be applied to bridges with uncontrolled frequency, potentially impacting and hurting the performance and safety of bridges. These vehicles were analyzed in this chapter using the Weigh-in-Motion (WIM) data. An overview of all the 6 million recorded vehicles for year 2007 is shown in Fig. F.3. This includes the distribution of gross weight, vehicle classification and the total axle numbers. The distribution of vehicle classes and total axles numbers of the vehicles indicate that over sixty percent of the vehicles have five axles, indicating large number of Class 9 semi-trailers on the road. In addition, 32% of the vehicles have two or three axles, indicating Class 4 (likely busses), Class 5 and Class 6 (likely utility trucks and small delivery trucks). In addition, four-axle concrete trucks and other 4-axle trucks take up another 5% of the total vehicles. Class 10 vehicles' share is about 1.3% while vehicles in Classes 10 through 15 contribute around 5% of total records.

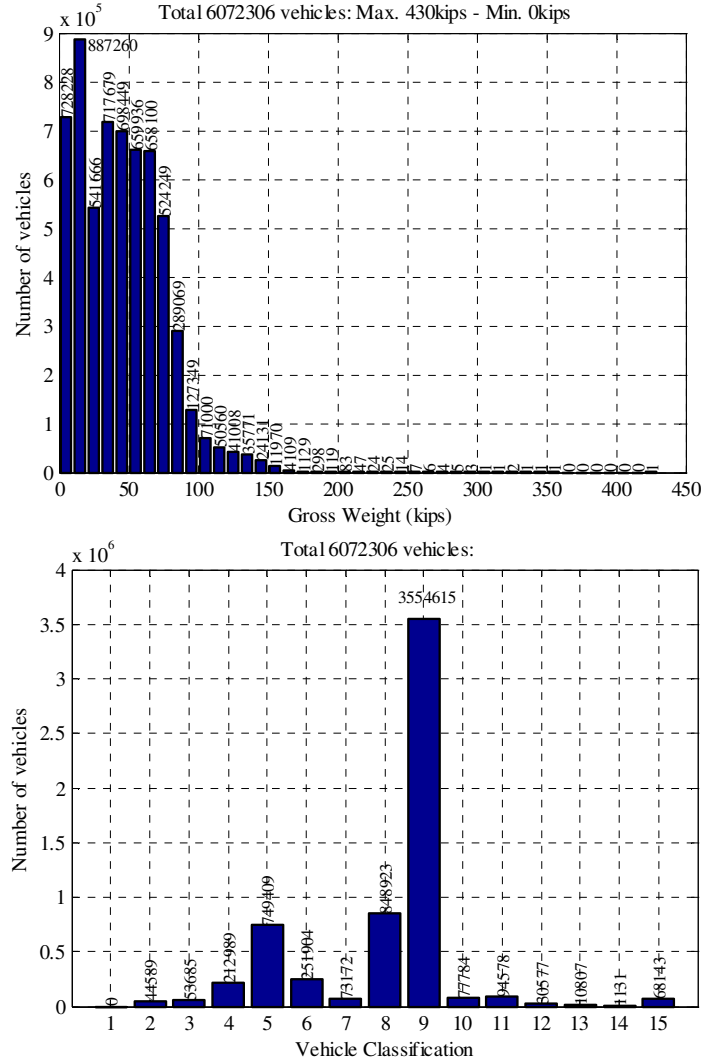

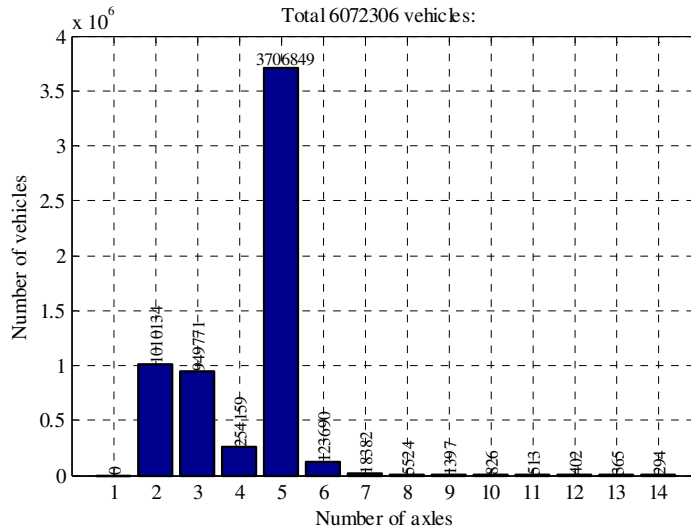

Fig. F.3 Overview of vehicles recorded in WIM data

The light vehicles will unlikely have an impact on highway bridges, thus can be excluded from the study. The recorded vehicles were classified per the criteria established (Table F.2) based on Wisconsin Statute Chapter 348³ and WisDOT Bridge Manual.⁶

Table F.2 Overweight criteria per Wisconsin Statute 0348

Axle configurations	Legal weight	Vehicles likely with annual permit	Vehicles likely with single-trip permit
Leading axle	≤13kips	≤20kips	>20kips
Single axle	≤20kips	≤30kips	>30kips
2-axle tandem	≤40kips	≤55kips	>55kips
3-axle tandem	≤60kips	≤70kips	>70kips
4-axle tandem	≤73kips	≤80kips	>80kips
5+-axle tandem	The gross weight of vehicles with permits likely exceeds the limits		
Gross Weight	≤80kips	≤170kips	>170kips

Note that the tandem axles are defined as groups of axles with spacing smaller than 6ft. Among the overweight records, around 1 million records are likely from the vehicles with multi-trip permits and about four hundred thousand records are likely from the vehicles with single-trip permits. All overloaded vehicle records were included in this study. The records for vehicles likely with single-trip permits were included because these vehicles are not necessarily heavier than the vehicles with annual permits. The majority of the total 1.4 million overweight records indicate that the total vehicle weight is below 170kips, the maximum gross weight of vehicles that is listed in the annual permit fee table. Specifically 1782 vehicles have gross weights that are larger than 170 kips, and only thirty three vehicles have gross vehicle weight larger than 250 kips. In addition, over 99% of the records show that the overall vehicle length is less than 75 ft, the upper limit for vehicles that can apply for annual permits. This indicates that the probability-based analysis adopted in this study is appropriate.

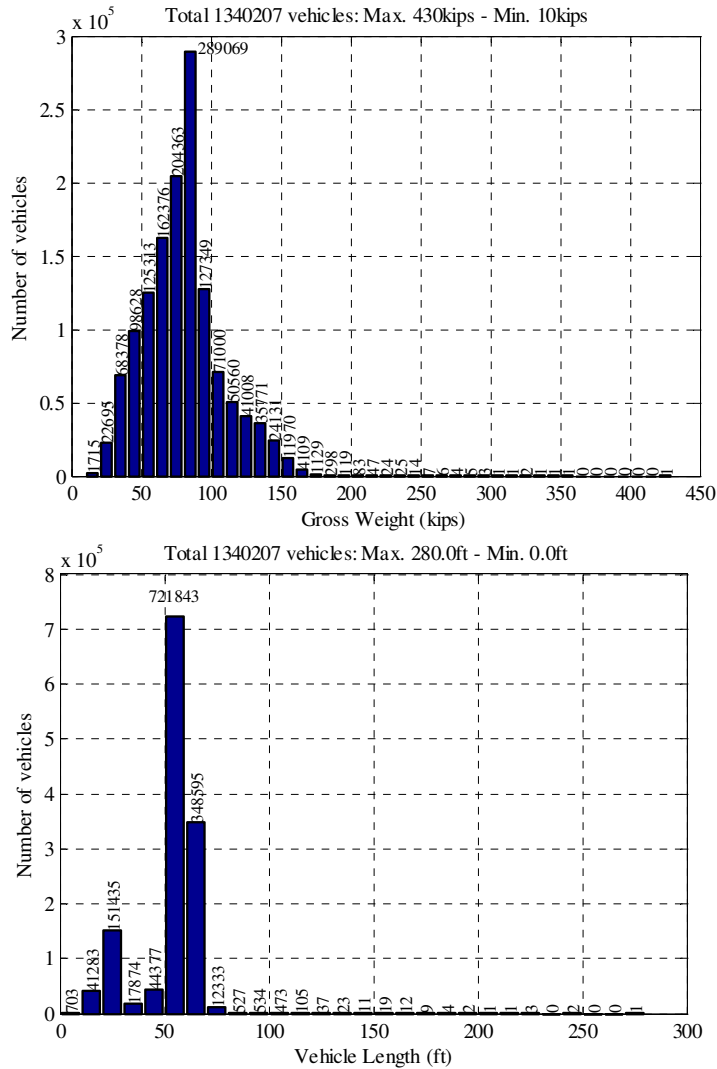

Fig. F.5 Distribution of overloaded vehicles recorded in WIM data

Analysis of Overloaded WIM Records

Vehicle records in each class were divided into groups based upon the total number of axles, and analyzed separately. The vehicles in each group are called data population. The characteristic values (e.g., the maximum, the minimum, the mean values, and the standard deviation) are calculated for each vehicle group. A representative vehicle was created to represent the approximate upper bound of the responses in simply-supported girders caused by the vehicles in the group. The representative vehicles were then compared with the Wis-SPV. The axle weights corresponding to 95th percentile of all axle weights in the group are used in the representative vehicles in each class. Axle spacings were analyzed individually: most axle spacings in a representative vehicle were taken as the average axle spacings; the spacings for tandem axles were taken as 4ft rather than the average spacings; and one axle spacing was taken as a variable spacing defined by the 5th percentile and 95th percentile values. Only one variable axle spacing is allowed because the program for the moving load analysis, SAP2000, can only take one variable axle spacing per vehicle.

The analysis of each vehicle is shown below. All pictures are modified from the pictures in <http://onlinemanuals.txdot.gov/txdotmanuals/tda/fhwavehicleclassificationfigures.htm>

Class 4 Vehicles

Class 4 vehicles are for traditional passenger carrying buses with two axles or three axles.



Two-axle buses: The statistical characteristics are shown below, based on which a representative vehicle was created as shown in Fig. F.6. The axles weights are in lbs and the axle spacings in ft.

21064 vehicles	Minimum	Maximum	Mean	Standard deviation	5 th percentile	95 th percentile
Gross weight	13448	99208	34588.28	8358.67	22046.23	50265.40
Axle weight 1	441	43872	15615.52	4216.87	9700.34	23589.47
Axle spacing 1	20	40	22.85	2.72	20.34	27.56
Axle weight 2	220	64155	18972.95	6905.49	3968.32	29762.41

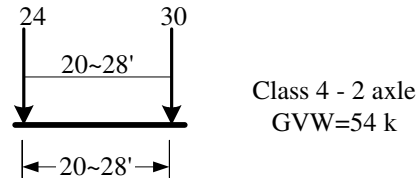

Fig. F.6 Representative vehicle for Class 4 vehicles (2-axle)

Three-axle buses: The statistical characteristics are shown below, and a representative vehicle was created as shown in Fig. F.7. Note that the last two axles likely form a tandem axle because the axle spacing 2 ranges from 2ft to 6ft with an average of 4ft.

20351 vehicles	Minimum	Maximum	Mean	Standard deviation	5 th percentile	95 th percentile
Gross weight	13669	113979	49878.51	12861.58	34392.12	76941.34
Axle weight 1	441	39904	17053.33	4642.62	12786.81	26675.94
Axle spacing 1	20	40	25.56	3.41	20.34	33.46
Axle weight 2	220	39904	18132.89	5760.93	9700.34	29321.49
Axle spacing 2	2	6	4.05	.30	3.61	4.59
Axle weight 3	220	43431	14691.73	5399.50	6613.87	24691.78

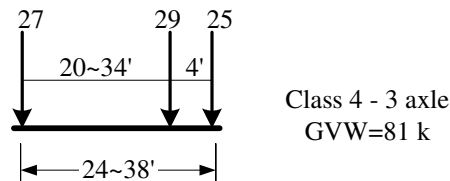

Fig. F.5 Representative vehicle for Class 4 vehicles (3-axle)

Class 5 Vehicles

Class 5 vehicles are for two-axle, six-tire, single-unit trucks, including camping and recreational vehicles, and motor homes.



The statistical characteristics are shown below, and a representative vehicle was created as shown in Fig. F.8. For the variable axle spacing, a smaller integer than the 5th percentile value

was used as the lower bound while a larger integer than the 95th percentile value was used for the upper bound.

20069 vehicles	Minimum	Maximum	Mean	Standard deviation	5 th percentile	95 th percentile
Gross weight	13228	78485	33339.49	7719.48	21164.38	47399.39
Axle weight 1	220	40786	14441.25	4106.92	8157.11	21605.31
Axle spacing 1	7	23	16.58	2.18	13.12	19.69
Axle weight 2	220	49604	18898.82	6761.30	4629.71	29101.02

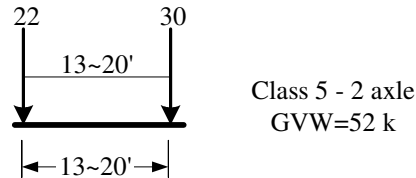

Fig. F.8 Representative vehicle for Class 5 vehicles

Class 6 Vehicles

Class 6 vehicles are for three-axle single-unit trucks, including camping and recreational vehicles, motor homes, etc.



The statistical characteristics are shown below, based on which a representative vehicle was created as shown in Fig. F.9. The spacing 1 in this class are affected by the wheelbase of the trucks, hence a variable spacing is used for axle spacing 1. The axle spacing 2 is dominated by length around 4.5ft, hence tandem axle spacing was used for axle spacing 2 though the recorded values varies from 2ft to 81 ft.

78523 vehicles	Minimum	Maximum	Mean	Standard deviation	5 th percentile	95 th percentile
Gross weight	14110	119931	42419.32	12201.99	26896.40	64815.92
Axle weight 1	220	41888	15613.52	3812.44	10582.19	23148.54
Axle spacing 1	4	41	17.33	2.70	12.47	21.65
Axle weight 2	220	46518	12729.35	5328.61	5952.48	22707.62
Axle spacing 2	2	81	4.38	1.82	3.94	4.59
Axle weight 3	220	51809	14075.93	6923.83	5291.10	27116.86

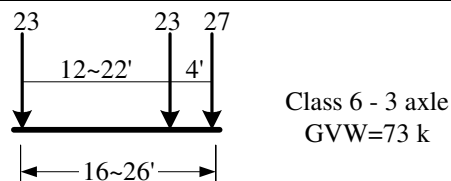

Fig. F.9 Representative vehicle for Class 6 vehicles

Class 7 Vehicles

Class 7 vehicles are for all trucks on a single frame with four or more axles.



Four-axle trucks: The statistical characteristics are shown below, based on which a representative vehicle was created as shown in Fig. F.10. The vehicle configuration was determined based upon the sample vehicle show above, where the rear three axles form a tandem axle. Hence the first spacing was set as the variable spacing while the other two axles were set as 4ft. Note that the gross weight of the representative vehicle is 99kips, which is larger than the 95th percentile of the gross weight (85kips) and smaller than the maximum gross weight (187kips).

15988 vehicles	Minimum	Maximum	Mean	Standard deviation	5 th percentile	95 th percentile
Gross weight	20944	187172	60172.07	13355.22	41226.45	84657.52
Axle weight 1	220	40345	17045.27	4078.27	11904.96	24691.78
Axle spacing 1	6	23	14.01	3.84	8.20	20.01
Axle weight 2	0	65698	10917.38	4881.32	4409.25	19621.14
Axle spacing 2	2	9	4.88	1.12	3.94	7.22
Axle weight 3	220	55336	16410.82	5480.89	8157.11	26235.01
Axle spacing 3	2	12	4.50	.75	3.94	5.91
Axle weight 4	220	59304	15797.90	6755.95	5070.63	27557.79

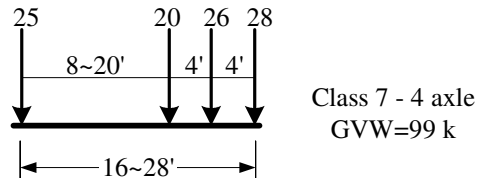

Fig. F.10 Representative vehicle for Class 7 vehicles (4-axle)

Five-axle trucks: Similarly the statistical characteristics for the five-axle trucks are shown below, based on which a representative vehicle was created as shown in Fig. F.11. The last three axle spacings are dominantly around 4ft, hence they were set as tandem axle spacing. Note that the middle two axles might be the lift axle, which are put in action when the truck is heavily loaded.

36234 vehicles	Minimum	Maximum	Mean	Standard deviation	5 th percentile	95 th percentile
Gross weight	20503	171961	71689.29	13614.29	55115.58	96782.95
Axle weight 1	220	45856	16860.91	3388.76	13007.28	22928.08
Axle spacing 1	3	23	9.87	1.88	7.87	13.78
Axle weight 2	220	39683	8126.03	2858.46	4188.78	13227.74
Axle spacing 2	2	9	4.16	.46	3.61	5.25
Axle weight 3	220	44533	11540.57	5890.71	4850.17	22707.62
Axle spacing 3	2	9	4.15	.25	3.94	4.59
Axle weight 4	220	44092	18014.21	4511.80	12345.89	26675.94
Axle spacing 4	2	9	4.35	.38	3.94	4.92
Axle weight 5	220	44974	17147.96	5863.93	7275.26	27337.33

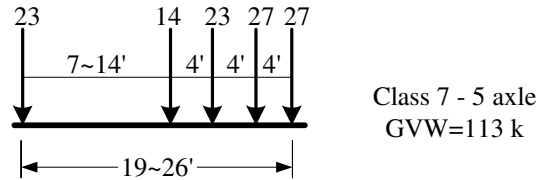
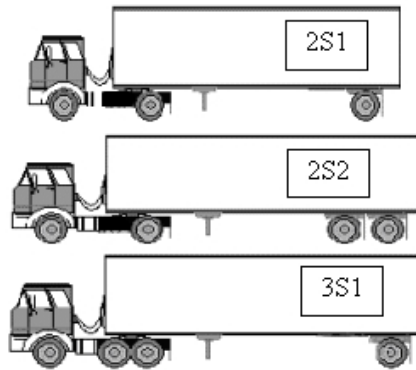

Fig. F.11 Representative vehicle for Class 7 vehicles (5-axle)

Class 8 Vehicles

Class 8 vehicles are for four or fewer axle single-trailer trucks -- All vehicles with four or fewer axles consisting of two units, one of which is a tractor or straight truck power unit.



Three-axle trucks: These trucks are likely AASHTO type 2S1. Their statistical characteristics are shown below, based on which a representative vehicle was created as shown in Fig. F.12. An average spacing of all vehicles was used for the steering spacing while a variable spacing is used for the second axle spacing to accommodate trailers in different sizes.

5789 vehicles	Minimum	Maximum	Mean	Standard deviation	5 th percentile	95 th percentile
Gross weight	14991	145285	47056.99	12938.70	29431.72	72862.79
Axle weight 1	220	39683	14340.07	4793.76	6613.87	22266.69
Axle spacing 1	6	23	12.97	2.23	9.19	16.40
Axle weight 2	220	72312	18542.33	6059.67	9369.65	28660.10
Axle spacing 2	11	40	25.04	6.57	15.91	37.40
Axle weight 3	220	72312	14173.91	7483.40	2425.09	26455.48

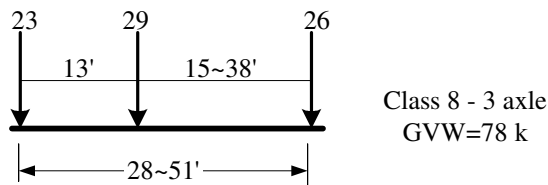

Fig. F.12 Representative vehicle for Class 8 vehicles (Type 2S1)

Four-axle trucks (a): These trucks are AASHTO type 3S1. The statistical characteristics are shown below, based on which a representative vehicle was created as shown in Fig. F.13. Again, an average spacing for the axle spacing of the truck power unit was used.

18469 vehicles	Minimum	Maximum	Mean	Standard deviation	5 th percentile	95 th percentile
Gross weight	14771	153001	64889.60	17772.36	36376.28	93255.55
Axle weight 1	220	39242	15352.84	4166.36	9479.88	22707.62
Axle spacing 1	4	38	16.21	2.31	11.81	19.36
Axle weight 2	220	39904	15635.57	5473.72	6834.33	24250.85
Axle spacing 2	1	6	4.27	.32	3.94	4.92

Axle weight 3	220	72312	17763.37	6586.90	7275.26	29541.95
Axle spacing 3	3	52	30.28	7.03	10.66	38.06
Axle weight 4	220	40786	16137.15	6963.89	4188.78	26896.40

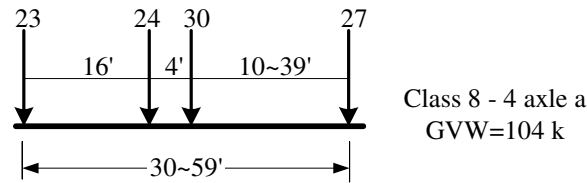

Fig. F.13 Representative vehicle for Class 8 vehicles (Type 3S1)

Four-axle trucks (b): These trucks are AASHTO type 2S2. The statistical characteristics are shown below, based on which a representative vehicle was created as shown in Fig. F.14.

9813 vehicles	Minimum	Maximum	Mean	Standard deviation	5 th percentile	95 th percentile
Gross weight	16535	150576	61545.31	17194.59	39683.21	97730.94
Axle weight 1	220	38581	14106.31	4614.69	7275.26	21825.77
Axle spacing 1	3	38	13.44	2.26	11.48	16.73
Axle weight 2	220	42990	20002.38	5948.90	9920.80	29762.41
Axle spacing 2	4	59	31.98	6.16	18.70	38.71
Axle weight 3	220	39683	12937.70	5754.70	5511.56	24912.24
Axle spacing 3	2	6	3.98	.40	3.61	4.59
Axle weight 4	220	61509	14498.61	6866.19	5511.56	27778.25

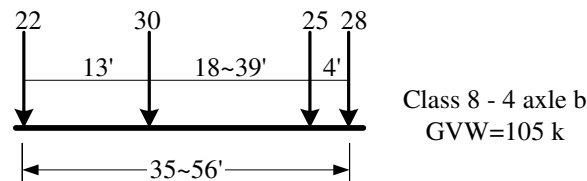
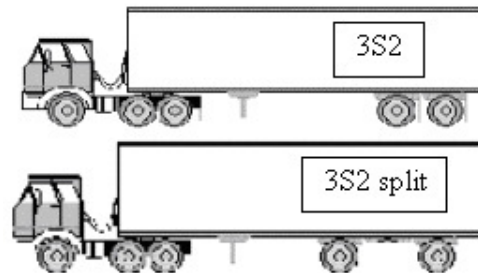

Fig. F.14 Representative vehicle for Class 8 vehicles (Type 2S2)

Class 9 Vehicles

Class 9 vehicles are for five-axle single-trailer trucks -- All five-axle vehicles consisting of two units, one of which is a tractor or straight truck power unit.



Due to the importance of this class (76 percent of the vehicles are in this class), the 2.5th and 97.5th percentile values were used to construct the representative vehicles. This is also justified by the distribution of gross vehicle weight: a small hump exists after 120kips, indicating considerably large number of vehicles. In addition, an average spacing for the axle spacing of the truck power unit was used. The distribution of axle spacing 4 shows two spikes: one near 4ft and the other at 10ft, indicating two distinguished vehicle types as show above Type 3S2 and Type 3S2 split. They were considered individually

Five-axle trucks (a): The statistical characteristics are shown below, based on which a representative vehicle was created as shown in Fig. F.15.

889230 vehicles	Minimum	Maximum	Mean	Standard deviation	2.5 th percentile	97.5 th percentile
Gross weight	17637	242509	84500.69	24627.43	44092.46	144843.73
Axle weight 1	220	47399	15663.98	4350.63	9038.95	25794.09
Axle spacing 1	2	31	16.28	2.16	11.15	20.01
Axle weight 2	220	46297	17063.44	5664.01	7716.18	30644.26
Axle spacing 2	2	46	4.19	.67	3.94	4.59
Axle weight 3	220	70548	18280.68	6093.33	7936.64	32187.50
Axle spacing 3	2	93	32.76	3.61	27.23	37.07
Axle weight 4	0	57100	16120.09	6089.37	5732.02	29982.87
Axle spacing 4	2	6	3.97	.21	3.61	4.59
Axle weight 5	0	70768	17372.47	6595.37	5952.48	31526.11

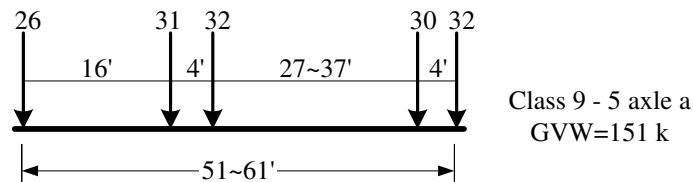

Fig. F.15 Representative vehicle for Class 9 vehicles (Type 3S2)

Five-axle trucks (b): The statistical characteristics are shown below, based on which a representative vehicle is created as shown in Fig. F.16. Note that the gross weight of this vehicle is similar to the Type 3S2 representative vehicle. Note that the split axle spacing was set to be 10 ft, close to the average spacing.

133972 vehicles	Minimum	Maximum	Mean	Standard deviation	2.5 th percentile	97.5 th percentile
Gross weight	20062	217596	85501.24	25551.90	41667.37	145284.66
Axle weight 1	220	39904	15413.54	4240.16	9038.95	25353.16
Axle spacing 1	3	44	17.94	2.09	13.12	21.33
Axle weight 2	220	39904	17160.95	5503.02	7936.64	29982.87
Axle spacing 2	2	45	4.24	.87	3.94	4.59
Axle weight 3	220	69005	18186.18	5824.22	7936.64	31085.18
Axle spacing 3	2	82	28.79	4.51	12.47	34.12
Axle weight 4	0	72312	17305.22	6902.23	4629.71	31746.57
Axle spacing 4	6	59	10.23	1.63	8.86	15.09
Axle weight 5	220	72312	17435.00	7061.48	4629.71	32187.5

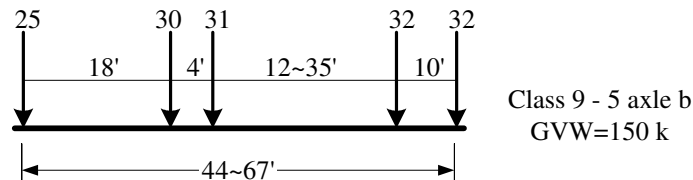
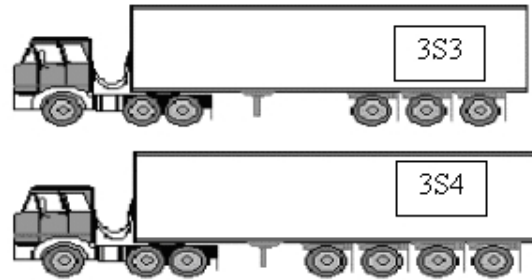

Fig. F.14 Representative vehicle for Class 9 vehicles (Type 3S2 split)

Class 10 Vehicles

Class 10 vehicles are for six or more axle single-trailer trucks -- All vehicles with six or more axles consisting of two units, one of which is a tractor or straight truck power unit..



Six-axle trucks: The statistical characteristics are shown below, based on which a representative vehicle is created as shown in Fig. F.17. The last three axles likely form a tandem axle; hence the last two spacings were set to be 4ft though the average values were different. The third spacing, which dictates the size of the trailer, varies from 4ft to 37ft, indicating that some single-unit trucks were included in this class. The heavy axle weight combined with the short spacing would likely cause large positive moment in simply supported girders.

27574 vehicles	Minimum	Maximum	Mean	Standard deviation	5 th percentile	95 th percentile
Gross weight	18078	267200	91073.17	23019.53	54895.11	136025.24
Axle weight 1	220	39463	13182.49	4188.96	7936.64	21605.31
Axle spacing 1	0	93	15.77	2.94	11.48	20.01
Axle weight 2	220	57100	16232.44	4895.11	9038.95	25353.16
Axle spacing 2	0	89	4.76	2.86	3.94	6.23
Axle weight 3	220	72312	17697.65	5775.52	9700.34	29101.02
Axle spacing 3	0	45	24.77	9.50	4.59	37.07
Axle weight 4	0	65257	12609.14	5481.83	4629.71	22266.69
Axle spacing 4	0	99	5.71	4.74	3.94	13.45
Axle weight 5	220	57982	15920.13	6282.96	5732.02	27116.86
Axle spacing 5	0	89	5.23	4.07	3.94	9.19
Axle weight 6	220	72312	15429.95	6862.19	3747.86	27557.79

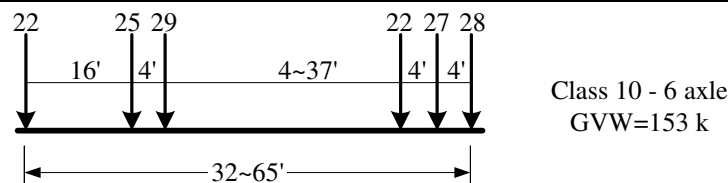

Fig. F.17 Representative vehicle for Class 10 vehicles (Type 3S3)

Seven-axle trucks: The statistical characteristics for these trucks are shown below, based on which a representative vehicle was created as shown in Fig. F.18. Similar to Type 3S3 vehicles, the third axle spacing varies from 4ft to 38ft. Hence, the short trucks would cause large positive moments in the simply-supported girder as shown later. Meanwhile, the total number of these vehicles is small, indicating a potentially insignificant impact to bridges.

2552 vehicles	Minimum	Maximum	Mean	Standard deviation	5 th percentile	95 th percentile
Gross weight	17857	235674	95229.00	30635.63	55556.50	157928.17
Axle weight 1	220	35054	13933.96	4074.49	8818.49	21384.84
Axle spacing 1	6	22	15.77	2.49	10.17	19.36
Axle weight 2	220	39904	15928.83	5435.96	8377.57	26235.01
Axle spacing 2	3	6	4.27	.23	3.94	4.59
Axle weight 3	441	39463	17124.27	6005.44	9259.42	29178.19

Axle spacing 3	3	40	28.24	9.68	3.94	37.40
Axle weight 4	220	35494	11183.80	5921.75	3968.32	22928.08
Axle spacing 4	3	13	5.02	1.59	3.61	8.86
Axle weight 5	220	39242	12413.44	6562.46	4409.25	24691.78
Axle spacing 5	3	12	4.23	.66	3.94	4.92
Axle weight 6	220	39904	12640.56	6457.33	4629.71	25132.70
Axle spacing 6	3	11	4.62	1.24	3.94	8.86
Axle weight 7	220	39022	12003.01	6183.32	4409.25	24250.85

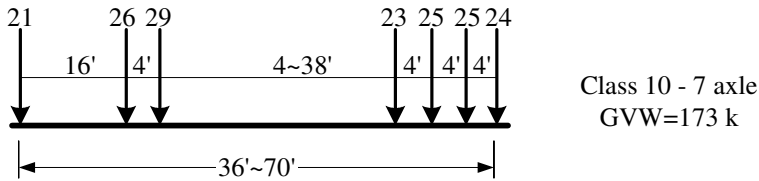
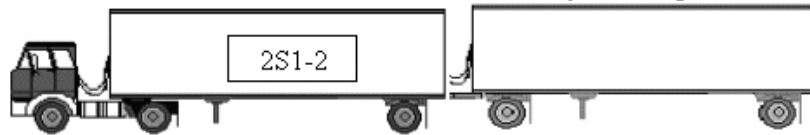

Fig. F.18 Representative vehicle for Class 10 vehicles (Type 3S4)

Class 11 Vehicles

Class 11 vehicles are for five or fewer axle multi-trailer trucks -- All vehicles with five or fewer axles consisting of three or more units, one of which is a tractor or straight truck power unit.



The statistical characteristics are shown below, based on which a representative vehicle was created as shown in Fig. F.19. The trailers might have similar dimensions such that the differences between the 5th percentiles and 95th percentiles of the spacings are small; hence, the representative vehicle does not have any variable spacing. The spacing between the trailers was set to the average value - 9ft. The wheelbases of the trailers are close (around 21ft).

28618 vehicles	Minimum	Maximum	Mean	Standard deviation	5 th percentile	95 th percentile
Gross weight	18739	181000	90554.27	23032.07	59304.36	132718.30
Axle weight 1	882	38140	16205.44	3948.83	10582.19	22928.08
Axle spacing 1	6	17	12.38	.45	11.81	13.12
Axle weight 2	441	39904	22814.27	5756.00	14550.51	33510.27
Axle spacing 2	11	25	20.98	.54	20.34	21.98
Axle weight 3	882	39683	18786.93	5812.25	10141.27	29101.02
Axle spacing 3	6	19	9.30	.39	8.86	9.84
Axle weight 4	220	39242	17325.68	5852.00	8598.03	27998.71
Axle spacing 4	11	25	21.87	.51	21.33	22.64
Axle weight 5	220	38140	15422.11	5227.66	7716.18	24912.24

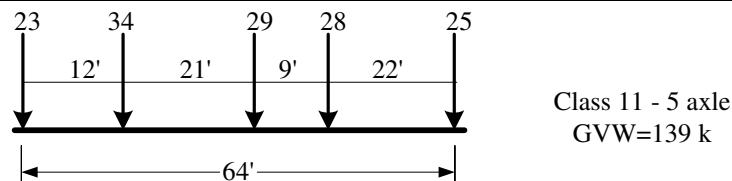
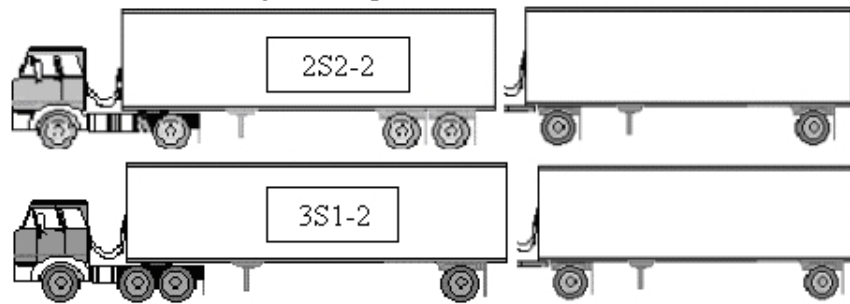

Fig. F.19 Representative vehicle for Class 11 vehicles

Class 12 Vehicles

Class 12 vehicles are for six-axle multi-trailer Trucks -- All six-axle vehicles consisting of three or more units, one of which is a tractor or straight truck power unit.



These vehicles are the combination of a semi-trailer and a trailer. Hence the configurations of the semi-trailers should be similar to those of Class 8 vehicles. The statistical characteristics are shown below, based on which a representative vehicle was created as shown in Fig. F.20. The second axle spacing ranges from 3ft to 6ft for all eleven thousand Class 12 vehicles, indicating that the number of type 2S2-2 vehicles seem rare in the WIM records. Hence the representative vehicle was created only for Type 3S1-2 vehicles. In addition, the dimension and weight of the trailers were same as those trailers in Class 11.

11011 vehicles	Minimum	Maximum	Mean	Standard deviation	5 th percentile	95 th percentile
Gross weight	34392	205250	96193.94	25863.89	61068.06	144182.34
Axle weight 1	1323	36597	16525.42	4204.99	10361.73	24250.85
Axle spacing 1	10	22	15.59	2.48	10.83	19.03
Axle weight 2	220	37258	14270.70	4310.195	8157.11	22266.69
Axle spacing 2	3	6	4.14	.235	3.94	4.27
Axle weight 3	220	39022	14678.29	4299.667	8377.57	22266.69
Axle spacing 3	3	25	19.24	3.746	4.59	21.33
Axle weight 4	1984	39022	17772.89	5728.475	9479.88	27998.71
Axle spacing 4	6	18	9.22	1.198	8.20	11.15
Axle weight 5	1102	39242	17049.24	5698.778	8598.03	27557.79
Axle spacing 5	11	25	21.75	1.645	18.04	22.97
Axle weight 6	2425	39683	15897.63	5427.705	7936.64	26014.55

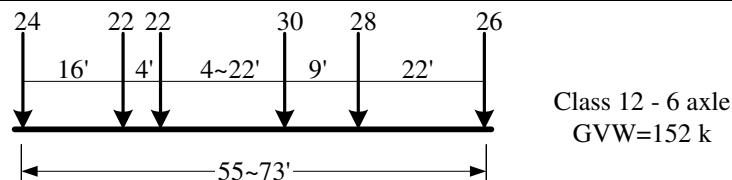
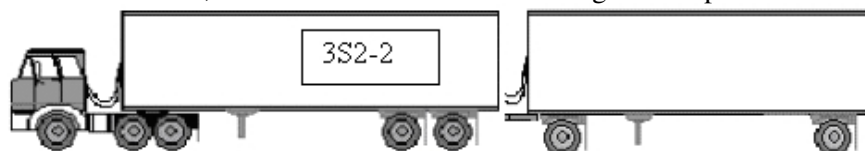

Fig. F.20 Representative vehicle for Class 12 vehicles

Class 13 Vehicles

Class 13 vehicles are for seven or more axle multi-trailer trucks -- All vehicles with seven or more axles consisting of three or more units, one of which is a tractor or straight truck power unit.



Class 13 includes both combination of trailers and nondivisible trucks potentially with permits. As a result, the distributions of the axle spacings were significantly scattered. In addition, 4579 out of 5105 Class 13 vehicles in the category are seven axle vehicles. Hence, the representative vehicles created below represents the 7-axle nondivisible trucks rather than Type 3S2-2 vehicles.

Seven-axle trucks (a): The statistical characteristics are shown below, based on which a representative vehicle was created as shown in Fig. F.21. The vehicle shown in Fig. F.21 is the representative of total 1116 trucks. The distribution of axle spacing 1 shows two peaks, indicating two distinctive vehicle types. However, considering the small total number of this category, an average spacing is used for the first axle spacing.

1116 vehicles	Minimum	Maximum	Mean	Standard deviation	5 th percentile	95 th percentile
Gross weight	22708	219580	89124.65	23196.26	52183.43	129984.57
Axle weight 1	220	36376	12581.96	4268.67	7054.79	20315.60
Axle spacing 1	3	27	13.26	5.58	5.91	21.98
Axle weight 2	220	34613	12406.73	5930.91	3527.40	22928.08
Axle spacing 2	0	105	7.69	9.09	3.94	15.14
Axle weight 3	220	39683	14905.50	5859.51	5511.56	25132.70
Axle spacing 3	3	45	16.50	14.51	3.94	41.99
Axle weight 4	220	30865	13123.63	5519.14	3527.40	21384.84
Axle spacing 4	3	6	4.42	.58	3.61	5.91
Axle weight 5	220	48722	10162.40	7325.10	1543.24	22046.23
Axle spacing 5	3	106	21.56	15.19	3.94	41.99
Axle weight 6	220	39683	13369.18	6901.66	1763.70	22928.08
Axle spacing 6	2	45	6.54	4.64	3.61	14.76
Axle weight 7	220	46077	12554.50	7375.30	1322.77	23589.47

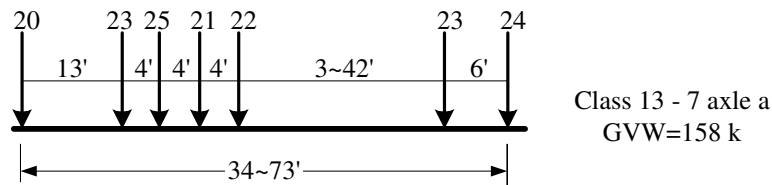

Fig. F.21 Representative vehicle for Class 13 vehicles

Seven-axle trucks (b): The statistical characteristics are shown below, based on which a representative vehicle was created as shown in Fig. F.22. The vehicle represents 3463 trucks. Note that the fourth spacing ranges from 7ft to 39ft, and the short truck would likely cause large positive moments in simply-supported girders.

3463 vehicles	Minimum	Maximum	Mean	Standard deviation	5 th percentile	95 th percentile
Gross weight	23589	248241	102497.72	25361.47	80027.81	154852.72
Axle weight 1	661	34613	11554.69	3433.36	7319.35	18077.91
Axle spacing 1	2	42	13.85	4.01	6.56	19.69
Axle weight 2	220	37699	12697.11	4793.58	5952.48	20502.99
Axle spacing 2	3	38	5.46	2.55	3.94	11.48
Axle weight 3	220	72312	17226.11	5045.03	11464.04	26896.40
Axle spacing 3	3	37	5.54	4.04	3.94	11.15
Axle weight 4	220	52470	15796.76	6395.99	5952.48	27293.23
Axle spacing 4	6	64	27.43	9.83	7.55	38.39
Axle weight 5	220	36817	15335.66	5654.44	3086.47	23986.30
Axle spacing 5	2	94	6.85	6.78	3.94	24.28
Axle weight 6	220	39904	16395.38	5993.86	3747.86	25794.09

Axle spacing 6	3	86	4.96	2.91	3.94	8.86
Axle weight 7	220	42108	13477.61	7615.91	1984.16	24912.24

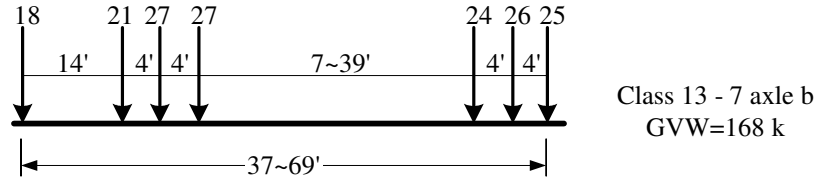

Fig. F.22 Representative vehicle for Class 13 vehicles

Class 14 Vehicles

Class 14 vehicles are for five-axle truck-trailer combinations-- vehicles with five axles consisting of two units, one of which is a truck and the other is a trailer.



The statistical characteristics are shown below, based on which a representative vehicle was created as shown in Fig. F.23. The total number of Class 14 vehicles is small compared with other classes; hence the statistical analysis should be treated with caution. With all four scattered spacing distributions, the axle spacing three was chosen to be the variable spacing only to separate the two relatively large load groups.

115 vehicles	Minimum	Maximum	Mean	Standard deviation	5 th percentile	95 th percentile
Gross weight	37699	101192	64233.13	16762.16	39903.68	88273.10
Axle weight 1	10141	21605	14932.01	2284.46	11419.95	19753.42
Axle spacing 1	8	26	19.80	2.07	16.93	22.05
Axle weight 2	5291	24692	14167.10	4685.64	7936.64	22222.60
Axle spacing 2	4	6	4.52	.28	4.27	4.92
Axle weight 3	6173	25574	13793.27	4799.73	6613.87	21561.21
Axle spacing 3	7	20	14.47	2.58	9.38	19.03
Axle weight 4	1323	23810	10622.45	4568.02	2866.01	17901.54
Axle spacing 4	12	27	16.70	3.03	12.47	22.11
Axle weight 5	2425	22928	10689.55	4921.15	3703.77	19488.87

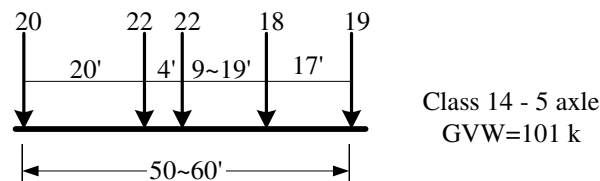

Fig. F.23 Representative vehicle for Class 14 vehicles

Comparison of Representative Overloaded Vehicles with Wis-SPV

The effects of the above representative overweight vehicles were compared with those of the 250-kip Wis-SPV. The analysis and the comparison used the same method as in Chapter 3.

One-span simply supported girders

The maximum positive moments and shear in simply-supported girders with various plan lengths by the 18 representative vehicles are shown in Fig. F.24, and the R-values are shown in Fig. F.25. Again, the effects of the Wisconsin Standard Permit Vehicle are shown in solid (blue) lines. The effects of the representative vehicles for Classes 10 and 13 exceed those of Wis-SPV, for spans from 40 to 80 ft as confirmed in Table F.3. In addition, the R-values for the representative vehicles for Classes 10 and 13 exceed 1.0, indicating that the moment envelopes exceeds that of the Wis-SPV throughout the entire span of the girders (from 40ft to 80ft). This might have been due to the fact that these three representative vehicles had a variable axle spacing. The vehicle with heavy loads could have short length when the variable spacing took the lower bound. Such short vehicles would likely cause large positive moment for short- to medium-span girders, for which several axles of Wis-SPV had to be placed outside the girder to obtain the maximum girder responses.

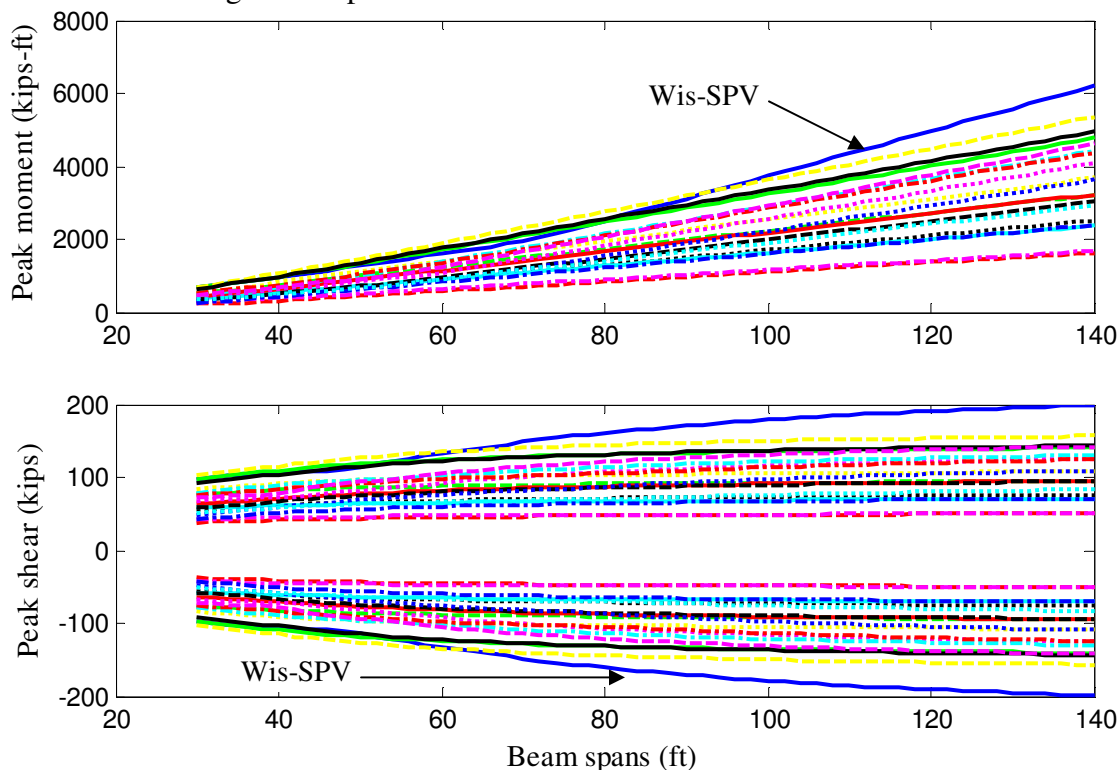

Fig. F.24 Peak moment/shear values for overweight vehicles on one-span girders

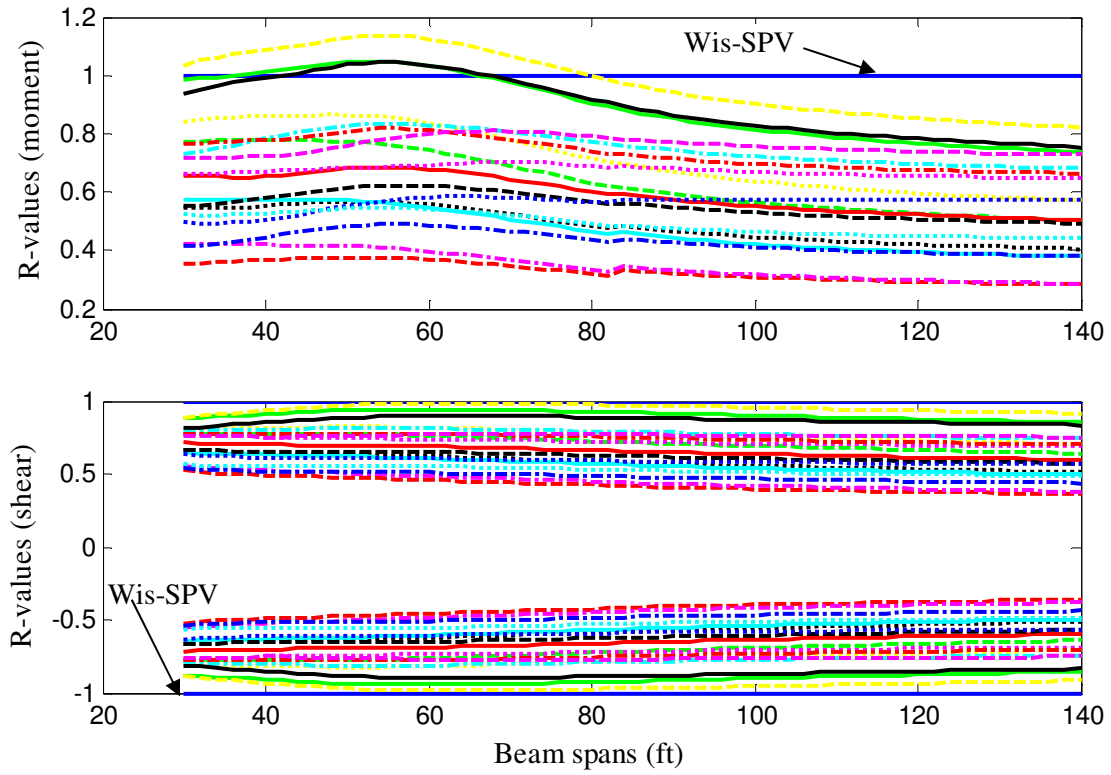

Fig. F.25 R-values for overweight vehicles on one-span girders

Table F.3(a) Peak positive moments in two-span girders by overweight vehicles (kips-ft)

Span (ft)	Wis. SPV	Class4 2axle	Class4 3axle	Class5 2axle	Class6 3axle	Class7 4axle	Class7 5axle	Class8 3axle	Class8 4axle a	Class8 4axle b	Class9 5axle a	Class9 5axle b	Class10 6axle	Class10 7axle	Class11 5axle	Class12 6axle	Class13 7axle a	Class13 7axle b	Class14 5axle
32	723.7	238.4	384.0	285.3	395.0	551.7	596.8	280.3	467.9	375.5	447.3	506.7	724.0	763.5	338.7	558.0	698.0	512.1	371.7
36	843.3	270.6	437.8	335.9	467.7	650.0	709.5	358.2	548.6	436.3	535.4	599.1	855.0	915.1	394.7	660.0	836.5	594.3	433.6
40	962.9	321.0	501.4	386.8	540.4	748.5	823.5	436.1	631.8	517.7	623.8	700.1	986.0	1066.8	450.9	762.0	975.0	687.7	495.5
44	1085.3	372.0	580.7	437.9	613.1	847.1	937.5	514.1	735.5	599.5	712.3	821.1	1117.0	1218.6	531.3	864.0	1121.2	781.1	557.5
48	1214.6	423.3	660.3	489.2	686.0	945.8	1051.5	592.0	839.1	681.4	800.8	942.8	1256.7	1370.4	621.2	986.2	1280.1	874.7	629.5
52	1344.2	475.0	740.0	540.5	758.8	1044.4	1165.5	670.0	942.7	763.6	889.5	1087.2	1409.2	1542.5	711.3	1112.2	1439.0	968.4	710.6
56	1473.7	526.9	819.9	592.0	831.7	1143.1	1279.5	748.0	1046.4	855.3	978.2	1238.0	1561.6	1715.4	801.4	1238.1	1598.0	1076.0	802.3
60	1603.2	579.0	899.8	643.5	904.6	1242.0	1393.5	825.9	1150.2	956.9	1078.9	1388.7	1714.1	1888.4	902.0	1364.1	1756.9	1236.9	903.3
64	1732.8	631.3	979.9	695.1	977.5	1340.8	1507.5	903.9	1254.1	1058.8	1227.7	1539.5	1866.5	2061.3	1012.5	1490.0	1915.8	1403.9	1004.2
68	1865.6	683.7	1060.0	746.8	1050.4	1439.7	1621.5	981.9	1357.9	1161.1	1376.5	1690.3	2019.1	2234.2	1123.6	1636.1	2074.8	1571.4	1105.2
72	2042.4	736.2	1140.2	798.4	1123.3	1538.5	1735.5	1059.8	1461.7	1263.7	1525.7	1841.0	2171.8	2407.2	1256.9	1788.1	2233.7	1739.0	1206.2
76	2267.4	788.8	1220.4	850.1	1196.1	1637.4	1849.5	1137.8	1565.6	1366.6	1675.2	1991.8	2324.6	2580.1	1395.7	1940.0	2392.6	1906.9	1307.1
80	2509.5	841.5	1300.7	901.8	1269.1	1736.2	1963.5	1215.8	1669.4	1469.5	1824.7	2142.5	2477.3	2753.0	1534.5	2092.0	2551.6	2075.2	1408.1
84	2753.1	894.2	1381.1	953.6	1342.1	1835.0	2077.5	1293.8	1773.2	1572.8	1974.2	2293.4	2630.1	2925.9	1673.2	2243.9	2710.5	2243.5	1509.0
88	2996.7	947.1	1461.5	1005.5	1415.0	1933.9	2191.5	1371.7	1877.1	1676.3	2124.1	2444.4	2782.9	3098.9	1812.0	2395.8	2869.5	2411.8	1610.0
92	3241.0	1000.0	1541.9	1057.3	1488.0	2032.8	2305.5	1449.7	1980.9	1779.8	2274.1	2595.3	2935.6	3271.8	1950.8	2547.8	3028.5	2580.3	1711.0
96	3486.1	1052.8	1622.3	1109.1	1561.0	2131.7	2419.5	1527.7	2084.9	1883.3	2424.1	2746.2	3088.4	3444.7	2089.6	2699.7	3187.5	2749.2	1812.0
100	3731.3	1105.7	1702.7	1160.9	1634.0	2230.7	2533.5	1605.6	2188.8	1987.2	2574.2	2897.2	3241.1	3617.7	2228.4	2851.7	3346.5	2918.2	1913.0
104	3976.4	1158.8	1783.1	1212.7	1706.9	2329.7	2647.5	1683.6	2292.8	2091.2	2724.2	3048.1	3393.9	3790.6	2367.1	3003.6	3505.5	3087.1	2014.0
108	4222.8	1211.8	1863.5	1264.5	1779.9	2428.6	2761.5	1761.6	2396.7	2195.2	2874.2	3199.0	3546.6	3963.5	2506.0	3155.5	3664.5	3256.0	2115.0
112	4469.2	1264.9	1944.0	1316.4	1852.9	2527.6	2875.5	1839.5	2500.7	2299.1	3024.5	3350.0	3699.4	4136.5	2644.9	3307.5	3823.5	3424.9	2216.0
116	4715.6	1318.0	2024.6	1368.3	1925.8	2626.5	2989.5	1917.5	2604.7	2403.1	3175.0	3500.9	3852.3	4309.4	2783.8	3459.4	3982.5	3593.8	2317.0
120	4962.0	1371.0	2105.2	1420.2	1998.8	2725.5	3103.5	1995.5	2708.6	2507.2	3325.4	3651.9	4005.3	4482.3	2922.8	3611.4	4141.5	3763.2	2418.0
124	5208.7	1424.1	2185.7	1472.1	2071.8	2824.5	3217.5	2073.5	2812.6	2611.6	3475.9	3802.8	4158.2	4655.3	3061.7	3763.3	4300.5	3932.5	2519.0
128	5456.2	1477.1	2266.3	1524.1	2144.7	2923.4	3331.5	2151.5	2916.5	2715.9	3626.3	3953.7	4311.2	4828.2	3200.7	3915.2	4459.5	4101.9	2620.0
132	5703.7	1530.3	2346.9	1576.0	2217.7	3022.4	3445.5	2229.5	3020.5	2820.2	3776.8	4104.7	4464.1	5001.1	3339.6	4067.2	4618.5	4271.3	2721.0
136	5951.3	1583.5	2427.4	1627.9	2290.7	3121.3	3559.5	2307.5	3124.4	2924.6	3927.3	4255.6	4617.0	5174.0	3478.6	4219.1	4777.5	4440.7	2822.0
140	6198.8	1636.7	2508.0	1679.8	2363.7	3220.3	3673.5	2385.5	3228.4	3028.9	4077.7	4406.6	4770.0	5347.0	3617.5	4371.1	4936.5	4610.1	2923.0

Table F.3(b) Peak shear in two-span girders by overweight vehicles (kips)

Span (ft)	Wis. SPV	Class4 2axle	Class4 3axle	Class5 2axle	Class6 3axle	Class7 4axle	Class7 5axle	Class8 3axle	Class8 4axle a	Class8 4axle b	Class9 5axle a	Class9 5axle b	Class10 6axle	Class10 7axle	Class11 5axle	Class12 6axle	Class13 7axle a	Class13 7axle b	Class14 5axle
32	100.44	38.39	56.71	43.05	58.61	78.22	85.94	44.26	65.42	59.23	68.85	79.97	98.72	105.71	50.95	76.85	95.31	73.10	53.10
36	103.72	40.06	59.38	44.04	60.21	80.53	89.06	48.01	67.15	62.48	71.09	84.97	104.74	110.85	55.40	79.64	100.16	75.42	56.20
40	106.35	41.39	61.51	44.84	61.49	82.38	91.55	51.01	70.83	66.73	72.88	88.97	109.57	115.06	58.96	82.92	104.05	78.67	58.68
44	108.50	42.48	63.26	45.49	62.53	83.89	93.59	53.46	73.84	70.21	75.48	92.25	113.52	120.33	62.91	86.84	108.92	85.34	60.71
48	110.80	43.39	64.71	46.03	63.40	85.15	95.29	55.51	76.36	73.11	79.60	94.98	116.81	124.72	67.17	90.10	113.10	90.89	62.40
52	118.23	44.16	65.94	46.49	64.14	86.22	96.73	57.24	78.48	75.56	83.23	97.29	119.59	128.43	70.77	93.02	116.63	95.59	63.83
56	125.86	44.82	66.99	46.89	64.78	87.13	97.97	58.72	80.31	77.66	88.07	99.27	121.98	131.62	73.86	95.52	119.66	100.58	65.06
60	132.47	45.40	67.91	47.23	65.32	87.92	99.03	60.01	81.89	79.49	92.26	101.75	124.05	134.38	76.53	97.68	122.28	105.21	66.12
64	138.64	45.90	68.71	47.52	65.80	88.61	99.97	61.13	83.27	81.08	95.93	104.82	125.86	136.79	78.88	99.58	124.57	109.26	67.05
68	145.19	46.34	69.41	47.79	66.23	89.22	100.80	62.12	84.49	82.49	99.17	107.54	127.45	138.92	80.94	101.25	126.60	112.83	67.87
72	151.01	46.73	70.04	48.02	66.60	89.77	101.53	63.01	85.57	83.74	102.05	109.96	128.87	140.81	82.78	102.74	128.40	116.01	68.60
76	156.22	47.08	70.60	48.23	66.94	90.25	102.19	63.79	86.54	84.86	104.63	112.12	130.14	142.51	84.50	104.07	130.01	118.85	69.25
80	160.91	47.40	71.11	48.42	67.24	90.69	102.78	64.50	87.41	85.86	106.95	114.06	131.28	144.03	87.22	105.26	131.46	121.41	69.84
84	165.15	47.68	71.56	48.59	67.52	91.09	103.31	65.15	88.20	86.77	109.04	115.82	132.32	145.41	89.68	106.34	132.77	123.72	71.08
88	169.00	47.94	71.98	48.75	67.77	91.44	103.80	65.73	88.92	87.60	110.95	117.41	133.26	146.66	91.93	108.05	133.96	125.82	72.44
92	172.53	48.18	72.36	48.89	67.99	91.77	104.24	66.26	89.58	88.36	112.69	118.88	134.12	147.81	93.97	109.96	135.05	127.74	73.68
96	175.75	48.40	72.70	49.02	68.20	92.07	104.65	66.75	90.18	89.05	114.29	120.21	134.90	148.86	95.85	111.71	136.05	129.50	74.82
100	178.72	48.60	73.02	49.14	68.39	92.35	105.02	67.20	90.73	89.69	115.75	121.45	135.63	149.82	97.58	113.32	136.97	131.12	75.87
104	181.47	48.78	73.32	49.25	68.57	92.61	105.37	67.62	91.24	90.28	117.11	122.58	136.29	150.72	99.17	114.81	137.81	132.62	76.84
108	184.00	48.95	73.59	49.35	68.74	92.84	105.69	68.00	91.71	90.82	118.37	123.63	136.91	151.54	100.64	116.19	138.60	134.00	77.73
112	186.36	49.11	73.85	49.44	68.89	93.06	105.98	68.36	92.15	91.33	119.53	124.61	137.49	152.31	102.01	117.47	139.33	135.29	78.56
116	188.56	49.26	74.08	49.53	69.03	93.27	106.26	68.69	92.56	91.80	120.62	125.52	138.02	153.02	103.29	118.66	140.00	136.49	79.34
120	190.60	49.40	74.30	49.61	69.16	93.46	106.52	69.00	92.94	92.24	121.63	126.37	138.52	153.69	104.48	119.77	140.64	137.60	80.06
124	192.52	49.53	74.51	49.69	69.29	93.64	106.76	69.29	93.30	92.65	122.58	127.17	138.99	154.31	105.59	120.81	141.23	138.65	80.73
128	194.32	49.65	74.70	49.76	69.40	93.81	106.98	69.57	93.63	93.04	123.47	127.91	139.43	154.89	106.64	121.79	141.79	139.63	81.37
132	196.00	49.76	74.89	49.83	69.51	93.96	107.20	69.82	93.95	93.40	124.30	128.61	139.84	155.44	107.62	122.70	142.31	140.55	81.96
136	197.59	49.87	75.06	49.89	69.61	94.11	107.40	70.06	94.24	93.74	125.09	129.27	140.23	155.96	108.54	123.56	142.80	141.41	82.52
140	199.09	49.97	75.22	49.95	69.71	94.25	107.59	70.29	94.52	94.07	125.83	129.89	140.59	156.45	109.41	124.38	143.26	142.23	83.05

Two-span continuous girders

The maximum positive moments and shear in two-span continuous girders with various span lengths by the 18 representative vehicles are shown in Fig. F.26, and the R-values in Fig. F.27. Similarly as shown in Table F.4, the effects of the Wis-SPV were exceeded by the three representative vehicles, whose variable axle spacing could cause short heavy vehicles.

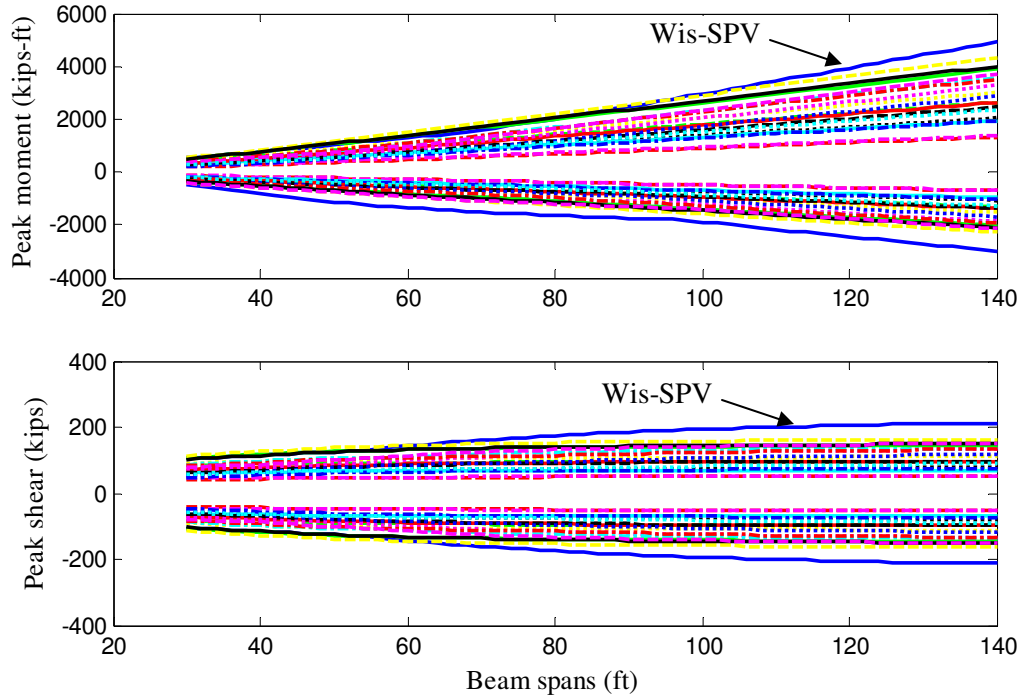

Fig. F.26 Peak moment/shear values for overweight vehicles on two-span girders

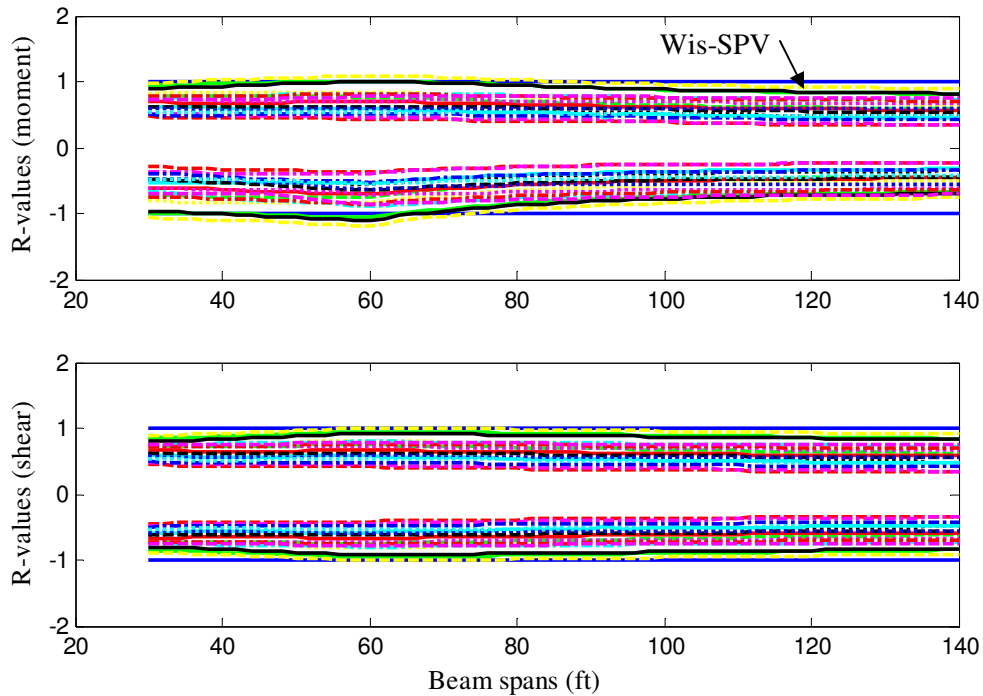

Fig. F.27 R-values for overweight vehicles on two-span girders

Table F.4(a) Peak positive moments in two-span girders by overweight vehicles (kips-ft)

Span (ft)	Wis. SPV	Class4 2axle	Class4 3axle	Class5 2axle	Class6 3axle	Class7 4axle	Class7 5axle	Class8 3axle	Class8 4axle a	Class8 4axle b	Class9 5axle a	Class9 5axle b	Class10 6axle	Class10 7axle	Class11 5axle	Class12 6axle	Class13 7axle a	Class13 7axle b	Class14 5axle
32	577.2	197.9	313.8	233.8	316.9	441.6	480.0	228.9	375.2	306.7	367.7	407.4	565.6	596.3	273.8	438.1	548.0	412.7	297.4
36	675.0	229.8	358.3	274.0	374.9	520.8	569.5	282.1	440.4	358.7	436.0	481.2	672.0	717.9	319.2	520.5	658.8	485.3	347.7
40	774.3	267.7	415.1	314.8	433.4	600.5	660.0	341.8	509.3	421.3	505.5	570.2	778.8	840.5	364.9	603.3	770.6	559.2	398.2
44	878.2	306.8	476.2	355.9	492.4	680.8	751.4	402.9	590.0	485.2	575.9	663.5	890.8	963.8	429.1	692.7	885.6	634.0	449.9
48	982.8	346.8	538.4	397.4	551.7	761.4	843.2	464.6	671.8	550.0	647.0	758.6	1010.8	1089.2	497.7	789.8	1011.8	709.3	512.2
52	1088.0	387.7	601.4	439.3	611.1	842.3	935.5	526.7	754.3	618.7	718.6	855.1	1132.0	1226.3	567.5	888.3	1138.9	785.2	575.6
56	1193.6	429.0	665.0	481.4	670.8	923.3	1028.0	589.3	837.5	696.0	790.5	968.3	1254.2	1364.5	641.1	987.8	1266.8	878.6	639.8
60	1299.5	470.6	729.1	523.6	730.5	1004.5	1120.8	652.1	921.1	774.7	869.6	1087.3	1377.0	1503.5	724.7	1088.1	1395.3	993.1	712.1
64	1405.7	512.6	793.5	565.9	790.4	1085.8	1213.9	715.2	1005.1	854.5	981.3	1207.1	1500.5	1643.1	809.7	1188.9	1524.2	1116.0	791.1
68	1528.5	554.9	858.2	608.3	850.3	1167.2	1307.3	778.5	1089.3	935.2	1094.9	1327.6	1624.3	1783.1	895.8	1300.8	1653.5	1241.3	871.2
72	1678.4	597.3	923.2	650.7	910.4	1248.8	1400.9	841.9	1173.8	1016.6	1210.0	1448.7	1748.7	1923.7	982.9	1419.8	1783.2	1370.3	951.7
76	1844.9	639.9	988.4	693.2	970.5	1330.3	1494.6	905.5	1258.5	1098.5	1326.3	1570.2	1873.2	2064.6	1081.0	1540.3	1913.1	1502.2	1032.5
80	2022.6	682.7	1053.8	735.8	1030.6	1412.0	1588.4	969.2	1343.4	1180.9	1443.6	1692.1	1998.0	2205.7	1189.3	1661.5	2043.1	1635.0	1113.7
84	2203.4	725.8	1119.3	778.4	1090.8	1493.6	1682.2	1033.0	1428.4	1263.7	1561.7	1814.3	2123.1	2347.1	1298.3	1783.1	2173.4	1768.6	1195.1
88	2386.8	769.0	1185.1	821.0	1151.0	1575.3	1776.1	1096.9	1513.6	1347.0	1680.6	1936.9	2248.4	2488.7	1407.8	1905.2	2303.8	1902.9	1276.7
92	2572.4	812.2	1251.0	863.6	1181.1	1657.1	1870.1	1160.8	1598.8	1430.9	1800.1	2059.7	2373.7	2630.5	1517.9	2027.6	2434.4	2037.8	1358.5
96	2760.0	855.6	1317.0	906.3	1271.5	1738.8	1964.1	1224.9	1684.1	1515.1	1920.1	2182.9	2499.3	2772.4	1628.4	2150.4	2565.0	2173.2	1440.5
100	2951.9	899.0	1383.0	949.1	1331.7	1820.6	2058.1	1289.0	1769.5	1599.5	2040.6	2306.0	2624.8	2914.3	1739.4	2273.5	2695.8	2309.1	1522.6
104	3146.4	942.5	1449.2	992.0	1392.0	1902.5	2152.2	1353.1	1855.0	1684.1	2161.5	2429.6	2750.7	3056.7	1850.6	2396.8	2826.7	2445.2	1604.9
108	3341.7	986.1	1515.4	1034.9	1452.4	1984.3	2246.4	1417.2	1940.6	1769.0	2282.8	2553.1	2876.5	3199.0	1962.3	2520.3	2957.6	2582.2	1687.2
112	3537.9	1029.6	1581.7	1077.8	1512.7	2066.2	2340.6	1481.4	2026.1	1853.8	2404.3	2676.8	3002.5	3341.4	2074.1	2644.0	3088.7	2719.3	1769.7
116	3734.9	1073.3	1648.0	1120.8	1573.1	2148.1	2434.8	1545.7	2111.8	1939.0	2526.3	2800.6	3128.5	3483.9	2186.1	2768.0	3219.7	2856.8	1852.3
120	3932.7	1116.9	1714.4	1163.7	1633.4	2230.0	2529.0	1610.0	2197.5	2024.2	2648.3	2924.5	3254.5	3626.4	2298.5	2892.0	3350.9	2994.5	1934.9
124	4131.0	1160.6	1780.8	1206.7	1693.8	2311.9	2623.2	1674.2	2283.1	2109.5	2770.7	3048.5	3380.6	3769.0	2411.1	3016.3	3482.1	3132.5	2017.7
128	4330.0	1204.3	1847.2	1249.6	1754.2	2393.8	2717.5	1738.5	2368.9	2194.9	2893.2	3172.6	3506.8	3911.7	2523.7	3140.5	3613.3	3270.6	2100.5
132	4529.5	1248.1	1913.7	1292.6	1814.6	2475.8	2811.7	1802.9	2454.7	2280.4	3015.9	3296.7	3632.9	4054.4	2636.6	3265.0	3744.6	3409.0	2183.3
136	4729.4	1291.8	1980.2	1335.6	1875.0	2557.7	2906.0	1867.3	2540.6	2366.0	3138.7	3420.8	3759.2	4197.2	2749.7	3389.5	3876.0	3547.5	2266.2
140	4929.8	1335.6	2046.7	1378.6	1935.4	2639.6	3000.3	1931.7	2626.4	2451.6	3261.7	3545.1	3885.5	4340.0	2862.8	3514.1	4007.3	3686.1	2349.2

Table F.4(b) Peak negative moments in two-span girders by overweight vehicles (kips-ft)

Span (ft)	Wis. SPV	Class4 2axle	Class4 3axle	Class5 2axle	Class6 3axle	Class7 4axle	Class7 5axle	Class8 3axle	Class8 4axle a	Class8 4axle b	Class9 5axle a	Class9 5axle b	Class10 6axle	Class10 7axle	Class11 5axle	Class12 6axle	Class13 7axle a	Class13 7axle b	Class14 5axle
32	-469.3	-153.7	-229.1	-144.1	-206.7	-273.5	-298.1	-195.2	-258.6	-270.5	-339.9	-334.1	-378.8	-410.8	-281.3	-307.0	-368.6	-404.3	-213.0
36	-547.7	-164.0	-244.9	-150.6	-219.4	-291.5	-316.8	-211.9	-276.7	-292.5	-371.3	-360.6	-409.3	-448.3	-308.7	-335.6	-397.3	-441.6	-228.9
40	-620.5	-174.0	-260.6	-156.4	-231.1	-308.2	-334.3	-228.4	-293.6	-314.3	-409.7	-394.2	-438.3	-485.7	-334.0	-365.4	-432.0	-479.6	-243.6
44	-688.0	-183.2	-276.3	-161.7	-241.8	-323.8	-350.8	-244.8	-309.6	-336.0	-448.4	-427.5	-465.9	-522.6	-357.1	-393.3	-466.3	-519.6	-257.4
48	-760.7	-191.6	-292.0	-166.6	-251.7	-338.3	-366.5	-261.1	-324.8	-357.6	-484.6	-460.5	-496.7	-559.3	-378.5	-419.7	-500.4	-556.9	-274.8
52	-831.6	-199.3	-307.8	-177.7	-260.8	-351.9	-386.0	-277.2	-347.1	-379.0	-518.3	-493.2	-528.9	-595.7	-398.3	-445.5	-534.4	-592.3	-297.5
56	-898.1	-206.5	-323.4	-188.7	-269.5	-364.8	-410.3	-293.2	-369.1	-400.3	-550.2	-525.7	-560.6	-631.8	-426.6	-478.6	-567.9	-627.4	-319.1
60	-960.5	-213.0	-338.3	-199.6	-278.0	-384.6	-434.3	-309.1	-391.0	-421.5	-581.5	-558.0	-592.2	-667.7	-455.7	-510.5	-601.4	-662.3	-339.6
64	-1019.2	-219.0	-352.4	-210.5	-293.2	-405.0	-458.1	-325.1	-412.9	-442.7	-612.7	-590.0	-623.8	-703.6	-483.6	-541.2	-634.6	-697.2	-358.9
68	-1074.3	-224.7	-365.5	-221.2	-308.4	-425.4	-481.9	-340.9	-434.6	-463.8	-643.8	-621.9	-655.3	-739.1	-509.9	-570.7	-667.7	-731.9	-377.2
72	-1126.3	-229.9	-378.0	-231.9	-323.5	-445.7	-505.6	-356.6	-456.2	-484.8	-674.8	-653.6	-686.6	-774.5	-534.9	-599.5	-700.8	-766.5	-394.7
76	-1175.1	-234.8	-389.6	-242.6	-338.5	-465.8	-528.9	-372.1	-477.7	-505.7	-705.5	-685.1	-717.6	-809.8	-558.7	-626.9	-733.4	-800.8	-411.0
80	-1221.2	-239.3	-400.8	-253.2	-353.5	-485.8	-552.3	-386.9	-499.0	-526.6	-736.1	-716.4	-748.6	-845.0	-581.1	-653.5	-765.9	-835.1	-426.7
84	-1264.7	-247.4	-411.3	-263.8	-368.4	-505.8	-575.5	-401.0	-519.6	-547.0	-765.3	-747.2	-779.4	-880.0	-602.6	-679.4	-798.4	-869.3	-441.5
88	-1305.9	-259.0	-421.1	-274.4	-383.2	-525.8	-598.7	-414.5	-539.3	-566.3	-793.1	-776.6	-809.4	-915.0	-623.0	-704.5	-830.8	-903.5	-455.6
92	-1344.9	-270.5	-430.6	-284.9	-398.0	-545.7	-621.9	-427.2	-558.2	-584.7	-819.5	-804.6	-837.7	-949.5	-642.4	-728.9	-863.2	-937.4	-469.1
96	-1381.9	-281.9	-439.7	-295.4	-412.8	-565.5	-644.8	-439.3	-576.3	-602.0	-844.7	-831.2	-864.7	-982.4	-660.9	-752.6	-895.1	-969.9	-481.9
100	-1417.0	-293.3	-448.2	-305.8	-427.5	-585.3	-667.8	-450.9	-593.8	-618.5	-868.4	-856.5	-890.2	-1013.6	-678.5	-775.6	-925.8	-1000.9	-494.1
104	-1450.2	-304.5	-457.8	-316.2	-442.2	-605.0	-690.8	-462.0	-610.6	-634.1	-891.4	-880.8	-914.7	-1043.7	-695.3	-798.2	-955.3	-1030.5	-505.9
108	-1482.2	-315.7	-474.8	-326.6	-456.9	-624.7	-713.7	-472.5	-626.9	-648.9	-912.8	-903.9	-937.8	-1072.0	-711.3	-820.1	-983.6	-1058.6	-517.2
112	-1511.9	-326.9	-491.6	-337.0	-471.4	-644.4	-736.4	-482.7	-642.5	-663.2	-933.5	-925.8	-959.9	-1099.4	-726.7	-841.8	-1010.9	-1085.3	-527.9
116	-1540.8	-338.1	-508.4	-347.4	-486.0	-664.1	-759.2	-492.5	-657.6	-676.5	-953.3	-947.1	-981.0	-1125.1	-741.4	-862.9	-1037.1	-1111.0	-548.5
120	-1568.2	-349.2	-525.2	-357.7	-500.6	-683.7	-781.9	-501.8	-676.5	-689.6	-972.2	-967.2	-1007.2	-1150.1	-755.6	-883.5	-1062.6	-1135.5	-571.6
124	-1594.4	-360.2	-541.9	-368.1	-515.1	-703.3	-804.6	-516.2	-698.1	-701.7	-990.2	-986.4	-1038.6	-1173.9	-771.6	-903.6	-1086.8	-1158.9	-594.6
128	-1619.3	-371.3	-558.5	-378.4	-529.5	-722.9	-827.2	-532.6	-719.6	-713.5	-1007.6	-1005.1	-1069.8	-1198.5	-793.0	-923.6	-1110.4	-1181.3	-617.5
132	-1643.3	-382.2	-575.2	-388.7	-544.0	-742.4	-849.8	-548.8	-741.1	-724.8	-1024.2	-1022.8	-1101.0	-1234.2	-814.1	-957.4	-1141.0	-1203.0	-640.1
136	-1666.4	-393.1	-591.7	-399.0	-558.5	-761.9	-872.4	-565.1	-762.4	-735.6	-1040.3	-1039.9	-1132.1	-1269.5	-834.5	-991.1	-1173.5	-1223.5	-662.7
140	-1688.3	-404.0	-608.2	-409.2	-573.0	-781.4	-895.0	-581.2	-783.8	-752.2	-1055.6	-1063.0	-1163.3	-1304.8	-854.9	-1024.7	-1205.9	-1243.4	-685.2

Table F.4(c) Peak shear in two-span girders by overweight vehicles (kips)

Span (ft)	Wis. SPV	Class4 2axle	Class4 3axle	Class5 2axle	Class6 3axle	Class7 4axle	Class7 5axle	Class8 3axle	Class8 4axle a	Class8 4axle b	Class9 5axle a	Class9 5axle b	Class10 6axle	Class10 7axle	Class11 5axle	Class12 6axle	Class13 7axle a	Class13 7axle b	Class14 5axle
32	105.01	39.09	57.90	44.57	60.98	82.20	90.62	46.66	70.65	60.84	71.84	84.64	106.05	114.48	53.40	83.53	103.49	78.03	55.64
36	107.45	40.25	59.72	45.16	61.94	83.53	92.48	47.72	71.69	62.62	73.92	88.15	108.24	117.68	55.74	85.23	106.47	80.23	57.86
40	109.56	41.26	61.30	45.68	62.76	84.68	94.08	50.01	72.57	64.16	75.94	91.18	110.38	120.43	58.65	86.68	109.05	82.30	59.79
44	111.81	42.14	62.68	46.12	63.48	85.67	95.48	52.01	73.33	66.26	77.69	93.81	113.36	122.82	61.20	87.93	111.28	84.07	61.47
48	113.78	42.91	63.89	46.51	64.12	86.55	96.71	53.77	75.03	68.85	79.21	96.12	116.00	124.91	63.44	90.22	113.23	85.60	62.95
52	115.88	43.59	64.97	46.86	64.68	87.33	97.79	55.33	76.88	71.16	80.52	98.16	118.34	126.75	65.42	92.72	114.95	86.92	64.26
56	117.73	44.20	65.93	47.17	65.17	88.01	98.75	56.73	78.53	73.22	81.67	99.96	120.42	128.56	67.18	94.93	116.94	88.41	65.41
60	119.71	44.74	66.79	47.44	65.61	88.63	99.62	57.98	80.00	75.08	82.78	101.56	122.30	131.12	70.05	96.92	119.38	92.16	66.44
64	121.46	45.23	67.57	47.69	66.01	89.18	100.39	59.10	81.34	76.75	85.26	103.00	123.98	133.43	72.65	98.69	121.57	95.56	67.36
68	123.03	45.66	68.27	47.91	66.37	89.69	101.09	60.11	82.54	78.27	87.50	104.29	125.51	135.52	75.00	100.29	123.55	98.63	68.19
72	124.41	46.06	68.91	48.11	66.70	90.14	101.73	61.03	83.63	79.65	89.54	105.46	126.90	137.42	77.14	101.74	125.35	101.44	68.94
76	126.35	46.42	69.48	48.30	67.00	90.56	102.31	61.87	84.62	80.90	91.39	106.51	128.16	139.14	79.08	103.05	126.99	103.99	69.62
80	130.98	46.75	70.01	48.47	67.27	90.93	102.84	62.64	85.53	82.05	93.08	107.47	129.31	140.73	80.86	104.24	128.49	106.33	70.23
84	135.25	47.06	70.50	48.62	67.52	91.28	103.33	63.34	86.37	83.11	94.95	108.34	130.37	142.18	82.49	105.33	129.86	109.20	70.79
88	139.21	47.33	70.94	48.76	67.75	91.60	103.77	63.98	87.14	84.08	97.44	109.50	131.35	143.52	83.99	106.33	131.13	111.89	71.30
92	142.87	47.59	71.35	48.89	67.96	91.90	104.19	64.58	87.84	84.97	99.74	111.27	132.25	144.75	85.36	107.24	132.29	114.39	71.77
96	146.27	47.83	71.73	49.01	68.16	92.17	104.57	65.13	88.50	85.80	101.88	112.92	133.09	145.90	86.64	108.09	133.37	116.70	72.21
100	149.93	48.05	72.09	49.13	68.34	92.43	104.92	65.64	89.11	86.57	103.86	114.44	133.86	146.95	87.82	108.87	134.38	118.85	72.61
104	153.81	48.25	72.41	49.23	68.51	92.66	105.26	66.11	89.67	87.28	105.71	115.86	134.58	147.94	88.91	109.59	135.31	120.85	72.98
108	157.44	48.44	72.72	49.33	68.67	92.88	105.56	66.55	90.20	87.95	107.44	117.18	135.25	148.86	89.93	110.26	136.17	122.71	73.32
112	160.84	48.62	73.00	49.42	68.82	93.09	105.85	66.96	90.69	88.57	109.05	118.42	135.87	149.71	90.87	110.88	136.99	124.46	73.63
116	164.03	48.78	73.27	49.50	68.96	93.28	106.12	67.35	91.15	89.15	110.55	119.57	136.46	150.52	91.76	111.47	137.74	126.08	73.93
120	167.02	48.94	73.52	49.58	69.09	93.46	106.37	67.71	91.58	89.69	111.97	120.65	137.01	151.27	92.58	112.01	138.46	127.62	74.20
124	169.84	49.08	73.75	49.66	69.21	93.63	106.61	68.05	91.98	90.20	113.30	121.67	137.53	151.98	93.36	112.51	139.12	129.05	74.95
128	172.50	49.22	73.97	49.73	69.32	93.79	106.83	68.36	92.36	90.68	114.55	122.62	138.01	152.64	94.35	113.00	139.75	130.41	75.81
132	175.00	49.35	74.18	49.80	69.43	93.95	107.04	68.66	92.72	91.13	115.72	123.52	138.47	153.27	95.79	114.25	140.34	131.68	76.62
136	177.36	49.47	74.37	49.86	69.53	94.09	107.24	68.95	93.06	91.56	116.84	124.37	138.90	153.86	97.14	115.42	140.90	132.88	77.38
140	179.60	49.59	74.56	49.92	69.63	94.22	107.43	69.21	93.38	91.96	117.88	125.18	139.31	154.41	98.43	116.53	141.42	134.01	78.10

Three-span continuous girders

The maximum moments and shear in three-span continuous girders with various span lengths by the 18 representative vehicles are shown in Fig. F.28, and the R-values in Fig. F.29. The three representative vehicles caused larger positive moments than Wis-SPV in almost all spans as shown in Table F.5.

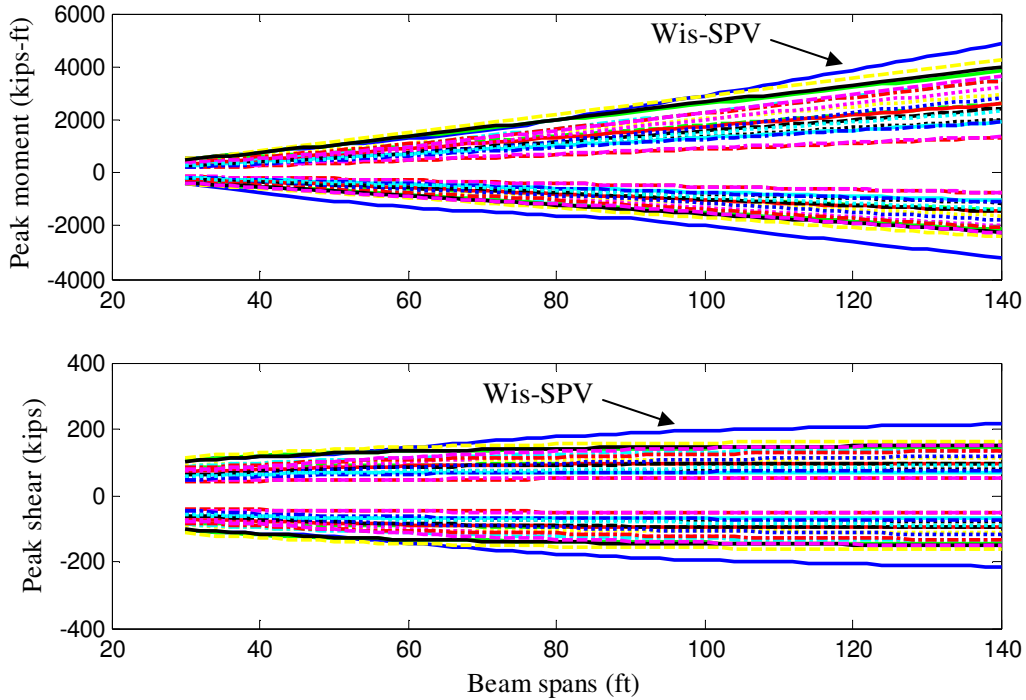

Fig. F.27 Peak moment/shear values for overweight vehicles on three-span girders

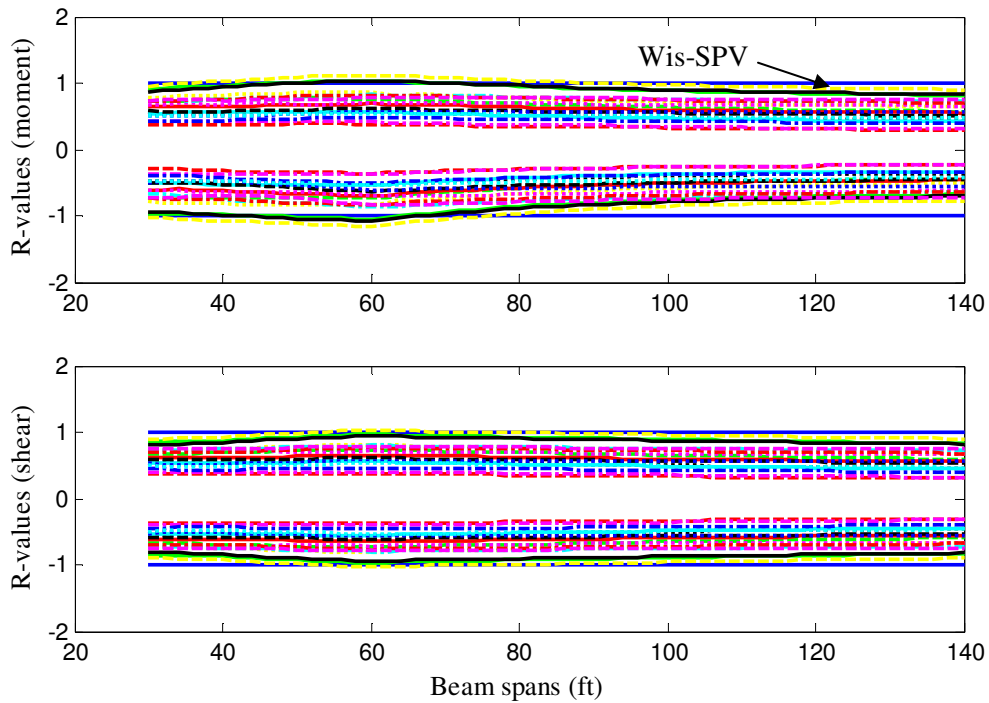

Fig. F.28 R-values for overweight vehicles on three-span girders

Table F.5(a) Peak positive moments in three-span girders by overweight vehicles (kips-ft)

Span (ft)	Wis. SPV	Class4 2axle	Class4 3axle	Class5 2axle	Class6 3axle	Class7 4axle	Class7 5axle	Class8 3axle	Class8 4axle a	Class8 4axle b	Class9 5axle a	Class9 5axle b	Class10 6axle	Class10 7axle	Class11 5axle	Class12 6axle	Class13 7axle a	Class13 7axle b	Class14 5axle
32	528.0	183.3	287.9	211.0	283.9	396.4	429.2	206.4	337.6	287.2	335.6	365.3	503.9	526.8	247.6	390.7	484.8	383.0	268.3
36	575.6	195.5	309.8	230.5	312.1	435.1	472.7	225.7	369.5	307.4	362.7	401.2	556.1	586.2	269.9	431.1	538.9	410.7	293.0
40	622.1	209.2	331.7	250.3	340.6	473.9	516.6	248.5	401.6	326.5	396.0	437.4	608.5	646.0	292.3	471.6	593.3	442.6	317.8
44	667.4	227.1	353.7	270.2	369.2	513.0	560.9	277.2	433.7	353.8	429.7	473.9	661.0	706.1	314.7	512.3	648.0	478.5	342.6
48	713.1	245.5	380.2	290.2	398.0	552.2	605.4	306.4	466.1	384.3	463.7	516.9	713.7	766.4	337.3	553.0	703.0	514.7	367.5
52	763.4	264.3	409.7	310.4	426.9	591.6	650.1	336.1	501.8	415.2	498.0	561.8	766.4	826.9	359.9	593.9	758.2	551.2	392.5
56	814.5	283.4	439.5	330.7	456.0	631.1	695.1	365.9	541.3	446.5	532.6	607.4	819.3	887.7	389.5	635.1	813.6	587.9	417.5
60	865.7	302.7	469.6	351.0	485.1	670.7	740.3	396.0	581.1	478.1	567.4	653.5	877.5	948.5	422.5	682.2	871.2	624.8	443.5
64	917.2	322.3	500.1	371.5	514.2	710.3	785.5	426.3	621.3	509.8	602.4	700.1	936.3	1009.5	455.9	729.9	933.1	661.9	473.9
68	968.8	342.0	530.8	392.0	543.5	750.1	830.9	456.7	661.6	541.8	637.5	747.1	995.5	1071.8	489.7	777.9	995.4	699.1	504.7
72	1020.4	361.9	561.7	412.5	572.8	789.9	876.4	487.2	702.1	574.0	672.6	794.5	1055.0	1139.0	523.8	826.2	1057.8	736.4	535.8
76	1072.3	382.1	592.8	433.1	602.2	829.9	922.0	517.9	742.9	609.8	708.0	842.2	1114.8	1206.7	558.3	874.9	1120.5	773.9	567.1
80	1124.3	402.4	624.1	453.7	631.6	869.9	967.7	548.6	783.8	647.5	743.4	893.0	1174.9	1274.6	593.0	923.8	1183.5	813.9	598.6
84	1176.4	422.8	655.5	474.6	661.1	909.9	1013.4	579.5	824.8	685.7	778.9	951.2	1235.2	1342.7	631.4	972.9	1246.5	866.0	630.3
88	1228.5	443.3	687.1	495.4	690.6	950.0	1059.2	610.4	866.0	724.2	814.5	1009.6	1295.7	1411.0	672.1	1022.2	1309.7	919.2	662.1
92	1280.8	463.9	718.7	516.2	720.1	990.1	1105.1	641.4	907.2	763.0	855.9	1068.2	1356.3	1479.5	713.4	1071.7	1373.1	978.4	700.0
96	1333.2	484.6	750.4	537.1	749.6	1030.2	1151.0	672.4	948.6	802.2	910.2	1127.1	1417.1	1548.4	754.9	1121.3	1436.6	1038.2	739.0
100	1385.6	505.3	782.2	558.0	779.2	1070.4	1151.0	703.5	990.0	841.5	965.2	1186.1	1478.0	1617.4	796.8	1171.0	1500.2	1098.8	778.2
104	1439.0	526.2	814.2	578.9	808.8	1110.5	1242.9	734.7	1031.6	881.2	1020.7	1245.4	1539.0	1686.5	839.0	1222.9	1563.8	1160.1	817.5
108	1507.7	547.0	846.1	599.9	838.4	1150.8	1288.9	765.9	1073.2	921.0	1076.5	1304.9	1600.2	1755.8	881.6	1280.7	1627.6	1221.8	856.9
112	1577.8	568.0	878.2	620.9	868.0	1191.0	1335.0	797.2	1114.8	961.0	1132.8	1364.7	1661.5	1825.2	924.3	1338.9	1691.5	1284.0	896.5
116	1655.1	588.9	910.3	641.8	897.7	1231.3	1381.2	828.5	1156.5	1001.2	1189.5	1424.6	1722.9	1894.7	967.3	1397.3	1755.4	1347.4	936.1
120	1733.1	609.9	942.5	662.8	927.3	1271.6	1427.3	859.9	1198.3	1041.5	1246.4	1484.5	1784.3	1964.2	1010.5	1456.2	1819.6	1412.1	975.9
124	1818.0	631.0	974.7	683.9	957.0	1311.9	1473.4	891.4	1240.2	1082.0	1303.7	1544.7	1845.8	2033.9	1061.2	1515.7	1883.8	1477.1	1015.7
128	1904.5	652.0	1006.9	704.9	986.7	1352.2	1519.6	922.8	1282.0	1122.6	1361.2	1604.8	1907.4	2103.6	1114.3	1575.2	1948.0	1542.4	1055.7
132	1991.9	673.2	1039.2	725.9	1016.4	1392.5	1565.8	954.3	1323.9	1163.3	1419.1	1665.2	1969.0	2173.3	1167.5	1635.0	2012.3	1607.9	1095.7
136	2080.0	694.3	1071.5	747.0	1046.1	1432.8	1612.1	985.8	1365.9	1204.1	1477.1	1725.5	2030.8	2243.1	1221.0	1694.8	2076.6	1673.6	1135.8
140	2169.0	715.5	1103.9	768.0	1075.8	1473.2	1658.4	1017.3	1407.8	1245.1	1535.4	1785.9	2092.5	2313.0	1274.6	1754.7	2141.0	1739.5	1175.9

Table F.5(b) Peak negative moments in three-span girders by overweight vehicles (kips-ft)

Span (ft)	Wis. SPV	Class4 2axle	Class4 3axle	Class5 2axle	Class6 3axle	Class7 4axle	Class7 5axle	Class8 3axle	Class8 4axle a	Class8 4axle b	Class9 5axle a	Class9 5axle b	Class10 6axle	Class10 7axle	Class11 5axle	Class12 6axle	Class13 7axle a	Class13 7axle b	Class14 5axle
32	-430.7	-148.0	-226.3	-141.3	-205.3	-275.2	-305.5	-190.6	-262.7	-257.9	-316.8	-317.2	-390.0	-412.2	-264.3	-312.6	-374.8	-377.0	-213.8
36	-504.5	-157.9	-241.9	-148.2	-218.9	-294.4	-325.8	-207.3	-282.3	-278.7	-348.1	-342.5	-422.8	-452.3	-290.9	-338.8	-409.6	-414.1	-230.7
40	-574.7	-167.8	-257.5	-154.5	-231.3	-312.4	-345.1	-223.7	-300.8	-299.3	-384.8	-375.4	-454.2	-490.7	-315.7	-368.4	-443.1	-451.2	-246.6
44	-640.8	-177.4	-273.0	-165.7	-242.9	-329.3	-363.2	-240.0	-318.2	-319.7	-424.0	-407.9	-484.1	-527.6	-338.7	-398.0	-475.0	-490.9	-261.5
48	-708.6	-186.2	-288.6	-177.6	-253.7	-345.1	-385.5	-256.2	-334.7	-340.1	-460.9	-440.1	-512.9	-563.1	-360.1	-426.2	-505.9	-528.8	-275.6
52	-775.6	-194.3	-304.2	-189.4	-263.7	-366.0	-411.5	-272.2	-350.5	-360.5	-495.6	-472.2	-540.7	-597.6	-379.9	-452.8	-535.8	-564.3	-293.0
56	-839.3	-201.8	-319.6	-201.1	-279.9	-388.1	-437.3	-288.1	-368.1	-380.7	-528.1	-504.0	-567.3	-630.6	-404.7	-487.0	-564.6	-598.3	-313.7
60	-900.1	-208.7	-335.1	-212.8	-296.3	-410.0	-463.0	-303.9	-390.3	-400.8	-559.1	-535.4	-593.2	-662.8	-434.4	-521.2	-595.3	-632.1	-333.8
64	-959.0	-215.2	-350.0	-224.4	-312.6	-431.8	-488.4	-319.7	-412.3	-420.8	-589.5	-566.7	-618.3	-694.1	-462.9	-554.2	-628.6	-665.7	-353.2
68	-1014.7	-221.2	-364.1	-235.9	-328.8	-453.5	-513.8	-335.4	-434.3	-440.9	-619.9	-597.8	-642.8	-724.7	-490.1	-586.0	-661.7	-699.3	-371.9
72	-1067.2	-226.8	-377.4	-247.3	-344.9	-475.2	-539.0	-351.1	-456.2	-460.9	-650.2	-628.8	-666.8	-754.7	-516.2	-616.9	-694.8	-732.7	-390.1
76	-1117.2	-238.9	-390.0	-258.7	-360.9	-496.6	-563.9	-366.6	-477.8	-480.8	-680.1	-659.6	-697.9	-783.6	-540.9	-646.8	-727.5	-765.9	-407.4
80	-1164.4	-251.4	-402.1	-270.0	-376.9	-518.0	-588.8	-382.1	-499.4	-500.6	-710.0	-690.1	-733.0	-814.7	-564.4	-675.8	-760.1	-799.0	-424.4
84	-1209.1	-263.8	-413.4	-281.3	-392.8	-539.4	-613.7	-397.1	-520.9	-520.4	-739.8	-720.6	-767.7	-852.1	-586.9	-704.0	-792.6	-832.1	-440.8
88	-1251.5	-276.1	-424.2	-292.6	-408.6	-560.7	-638.4	-411.3	-542.0	-539.9	-768.8	-750.7	-802.4	-891.8	-608.4	-731.4	-827.9	-865.1	-456.8
92	-1291.7	-288.5	-434.7	-303.8	-424.4	-581.9	-663.1	-424.8	-562.2	-558.5	-796.5	-779.8	-836.9	-931.2	-628.9	-758.0	-864.1	-898.0	-472.4
96	-1330.0	-300.6	-451.7	-315.0	-440.1	-603.1	-687.6	-437.9	-581.7	-576.2	-822.8	-807.5	-871.1	-970.3	-648.6	-784.0	-900.1	-930.8	-487.5
100	-1366.4	-312.7	-470.0	-326.1	-455.9	-624.1	-687.6	-450.4	-605.2	-593.0	-848.0	-834.1	-905.2	-1009.4	-667.3	-809.4	-935.8	-962.8	-502.3
104	-1400.9	-324.7	-488.2	-337.2	-471.6	-645.2	-736.6	-462.3	-628.6	-609.1	-872.2	-859.6	-939.2	-1048.4	-685.3	-834.2	-971.3	-993.5	-516.8
108	-1434.3	-336.6	-506.3	-348.3	-487.2	-666.2	-761.1	-479.9	-652.0	-624.3	-894.9	-883.8	-973.2	-1087.0	-704.4	-858.3	-1006.8	-1022.8	-534.8
112	-1465.3	-348.6	-524.3	-359.4	-502.8	-687.2	-785.4	-497.8	-675.4	-639.0	-917.0	-907.1	-1006.9	-1125.4	-730.3	-881.9	-1042.2	-1050.6	-559.9
116	-1495.7	-360.5	-542.2	-370.5	-518.3	-708.2	-809.6	-515.4	-698.5	-657.4	-938.1	-929.6	-1040.6	-1163.8	-755.4	-905.1	-1077.3	-1077.5	-584.9
120	-1524.3	-372.4	-560.1	-381.5	-533.8	-729.1	-833.9	-532.9	-721.5	-681.9	-958.3	-958.0	-1074.2	-1202.1	-780.1	-927.8	-1112.3	-1103.3	-609.5
124	-1551.8	-384.2	-577.9	-392.5	-549.3	-750.0	-858.1	-550.5	-744.5	-706.2	-977.6	-993.6	-1107.6	-1240.2	-804.1	-950.3	-1147.3	-1127.8	-634.1
128	-1578.1	-396.0	-595.7	-403.5	-564.7	-770.9	-882.2	-568.0	-767.4	-730.4	-996.3	-1028.9	-1140.9	-1278.2	-827.7	-984.8	-1182.2	-1151.5	-658.5
132	-1603.3	-407.6	-613.4	-414.5	-580.2	-791.8	-906.3	-585.3	-790.3	-754.5	-1014.2	-1063.9	-1174.2	-1316.2	-850.6	-1021.0	-1216.9	-1174.3	-682.7
136	-1627.7	-419.2	-631.1	-425.5	-595.6	-812.5	-930.4	-602.6	-813.1	-778.5	-1031.5	-1098.8	-1207.4	-1353.9	-873.3	-1057.0	-1251.5	-1196.1	-706.8
140	-1650.9	-430.9	-648.7	-436.4	-611.1	-833.3	-954.5	-619.9	-835.9	-802.3	-1048.1	-1133.7	-1240.6	-1391.6	-895.2	-1092.9	-1286.1	-1217.2	-730.8

Table F.5(c) Peak shear in three-span girders by overweight vehicles (kips)

Span (ft)	Wis. SPV	Class4 2axle	Class4 3axle	Class5 2axle	Class6 3axle	Class7 4axle	Class7 5axle	Class8 3axle	Class8 4axle a	Class8 4axle b	Class9 5axle a	Class9 5axle b	Class10 6axle	Class10 7axle	Class11 5axle	Class12 6axle	Class13 7axle a	Class13 7axle b	Class14 5axle
32	105.43	39.20	58.09	44.70	61.20	82.55	91.05	46.39	70.49	61.05	71.79	84.48	106.19	114.72	52.91	83.47	103.75	77.64	55.44
36	107.68	40.38	59.91	45.30	62.15	83.88	92.91	47.95	71.54	62.84	73.65	88.02	108.39	117.94	55.46	85.18	106.76	79.62	57.67
40	109.66	41.39	61.50	45.81	62.98	85.02	94.51	50.25	72.43	64.39	75.43	91.09	110.94	120.71	58.38	86.65	109.35	81.46	59.61
44	111.64	42.27	62.89	46.26	63.70	86.01	95.90	52.27	73.33	66.51	77.01	93.75	113.93	123.11	60.95	87.91	111.59	83.09	61.31
48	113.41	43.05	64.12	46.65	64.33	86.88	97.12	54.04	75.42	69.12	78.41	96.09	116.57	125.21	63.21	90.19	113.56	84.52	62.81
52	115.21	43.74	65.20	46.99	64.89	87.65	98.20	55.62	77.28	71.45	79.64	98.15	118.92	127.06	65.21	92.70	115.29	85.77	64.13
56	116.84	44.34	66.17	47.30	65.38	88.33	99.16	57.02	78.93	73.53	80.74	99.97	121.00	129.27	67.00	94.94	117.63	88.57	65.30
60	118.51	44.89	67.03	47.57	65.82	88.94	100.02	58.27	80.41	75.40	82.72	101.59	122.88	131.83	69.90	96.94	120.07	92.37	66.34
64	120.03	45.38	67.80	47.82	66.21	89.49	100.78	59.40	81.74	77.08	85.24	103.04	124.56	134.14	72.53	98.73	122.26	95.80	67.28
68	121.45	45.81	68.51	48.04	66.57	89.99	101.48	60.42	82.95	78.61	87.51	104.35	126.08	136.23	74.91	100.34	124.24	98.92	68.12
72	123.22	46.21	69.14	48.24	66.90	90.44	102.11	61.34	84.04	79.99	89.58	105.53	127.47	138.13	77.08	101.80	126.04	101.75	68.88
76	126.89	46.57	69.72	48.42	67.19	90.84	102.68	62.18	85.03	81.26	91.46	106.59	128.73	139.85	79.05	103.12	127.67	104.33	69.57
80	131.56	46.90	70.24	48.58	67.46	91.21	103.20	62.94	85.94	82.41	93.18	107.56	129.88	141.43	80.85	104.32	129.17	106.83	70.19
84	135.88	47.20	70.73	48.73	67.70	91.56	103.68	63.64	86.77	83.47	95.41	108.45	130.93	142.88	82.51	105.43	130.54	109.77	70.76
88	139.87	47.48	71.17	48.87	67.93	91.87	104.12	64.29	87.53	84.44	97.92	110.13	131.90	144.21	84.03	106.43	131.80	112.49	71.28
92	143.56	47.74	71.58	49.00	68.14	92.16	104.53	64.88	88.24	85.34	100.24	111.90	132.80	145.44	85.42	107.36	132.96	115.00	71.76
96	146.99	47.97	71.96	49.12	68.33	92.43	104.90	65.43	88.89	86.17	102.39	113.55	133.62	146.58	86.71	108.21	134.03	117.32	72.19
100	150.67	48.19	72.31	49.23	68.51	92.68	104.90	65.94	89.49	86.93	104.39	115.08	134.39	147.63	87.91	109.00	135.03	119.48	72.60
104	154.59	48.39	72.64	49.33	68.68	92.91	105.58	66.41	90.05	87.65	106.25	116.50	135.11	148.61	89.01	109.72	135.95	121.49	72.97
108	158.25	48.58	72.94	49.43	68.83	93.13	105.88	66.85	90.58	88.31	107.98	117.82	135.77	149.52	90.04	110.40	136.81	123.37	73.32
112	161.68	48.76	73.22	49.52	68.98	93.33	106.16	67.25	91.06	88.93	109.61	119.06	136.39	150.37	91.00	111.02	137.61	125.12	73.64
116	164.89	48.92	73.48	49.60	69.11	93.52	106.42	67.63	91.52	89.51	111.12	120.21	136.97	151.16	91.89	111.61	138.37	126.75	73.94
120	167.91	49.07	73.73	49.68	69.24	93.69	106.67	67.99	91.94	90.05	112.54	121.29	137.51	151.91	92.73	112.16	139.07	128.29	74.51
124	170.75	49.22	73.96	49.75	69.36	93.86	106.90	68.33	92.34	90.56	113.87	122.30	138.02	152.60	93.51	112.67	139.73	129.73	75.42
128	173.42	49.35	74.18	49.82	69.47	94.02	107.12	68.64	92.72	91.04	115.13	123.26	138.49	153.26	94.91	113.70	140.35	131.09	76.28
132	175.94	49.48	74.38	49.89	69.58	94.16	107.33	68.94	93.07	91.49	116.31	124.15	138.95	153.88	96.36	114.95	140.93	132.36	77.08
136	178.31	49.60	74.58	49.95	69.68	94.30	107.52	69.22	93.41	91.91	117.42	125.00	139.37	154.46	97.72	116.12	141.48	133.56	77.84
140	180.56	49.71	74.76	50.01	69.77	94.43	107.71	69.48	93.72	92.31	118.47	125.80	139.77	155.01	99.01	117.23	142.00	134.70	78.56

Summary of the girder responses to representative vehicles

The positive moment / shear envelopes of the Wis-SPV were breached by the following three representative vehicles all three types of girders (i.e., simply supported, 2-span continuous and 3-span continuous girders). This is due to the fact that the variable spacings in these representative vehicles all have a small lower bound (e.g., 4ft) such that the last five or six axles literally becomes a heavy axle group. Considering the definitions of the two classes, it was very likely that some non-divisible trucks had been recorded in Class 13 vehicles, and some single unit trucks, potentially with multiple lift axles, had been recorded in Class 10 vehicles.

Meanwhile, it should be noted that heavy vehicles in other classes, the representative vehicles of which did not show larger maximum girder response, could possibly cause large moments than Wis-SPV. This is due to the fact that the representative vehicles were established to represent top 5% heavy vehicles in each class rather than representing the heaviest trucks. Hence, the representative vehicles were quantified before being used for estimating the probability of the heavy trucks cause larger bridge response than the Wis-SPV.

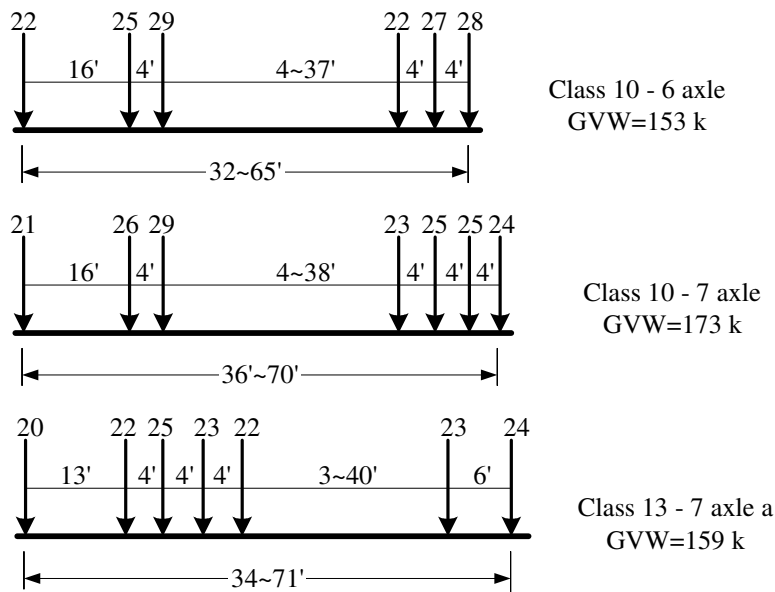

Evaluation of representative overloaded vehicles

To determine how closely the proposed representative vehicles represents the overweight vehicles in the term of bridge girder responses. Fifty vehicles were randomly selected from the vehicles that have top 5% of gross vehicle weight in each vehicle class/group. It was deemed that heavier vehicles in a certain class/group would most likely produce larger girder responses because the vehicle configurations are similar in the class/group. Girder analyses were conducted for each randomly selected vehicle on two randomly selected girder spans. The representative vehicles could then be positioned within the top 5% heaviest vehicles in each class/group by comparing the obtained girder responses with that of the representative vehicle. The comparison for the representative vehicle in Class 9, Type 3S2 vehicles is shown below in details to illustrate the process. The comparison for other representative vehicles was tabulated in Table F.6.

The girder responses of the randomly selected vehicles are plotted in Fig. F.29, in which the responses by the representative vehicle as shown in Fig. E15 for Type 3S2 vehicles are shown in solid (blue) lines, the responses by the Wis-SPV are shown in black dashed lines, and the

randomly selected vehicles are shown in various marks. Due to the random nature of the analyses, the selected vehicles covered the entire span range of interest though only two spans were calculated for each vehicle. The girder responses of the selected vehicles closely followed the responses of the representative vehicle, indicating that the representative vehicle had properly represented the top 5% overweight vehicles.

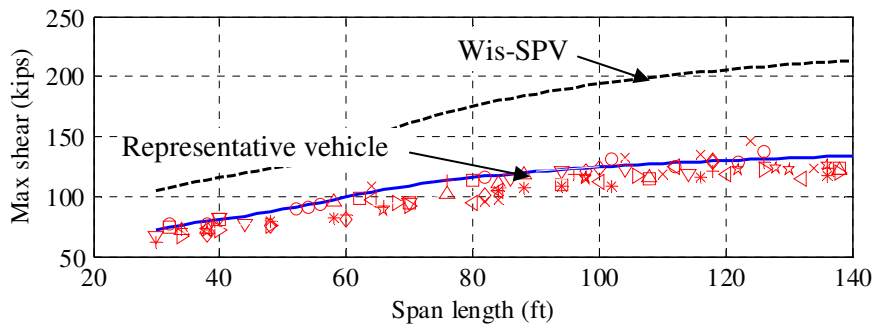
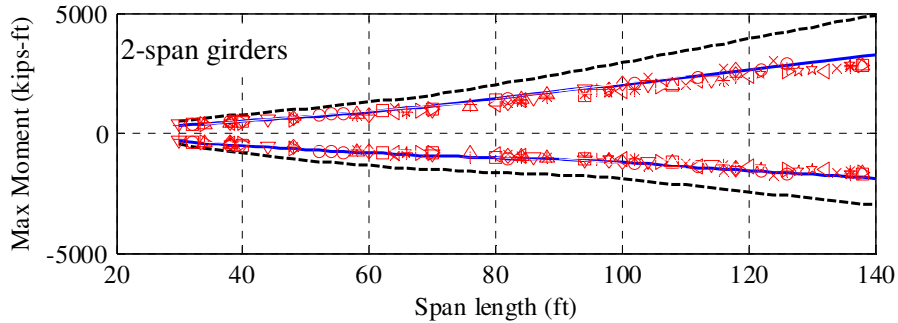
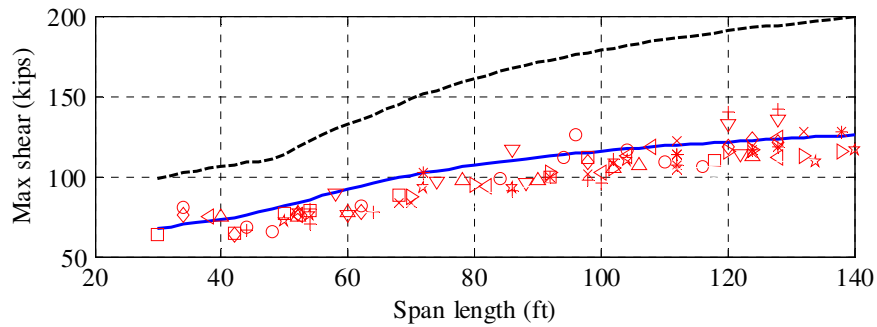
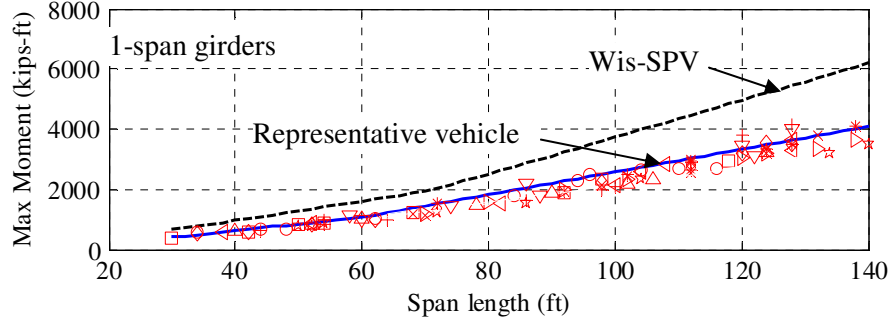

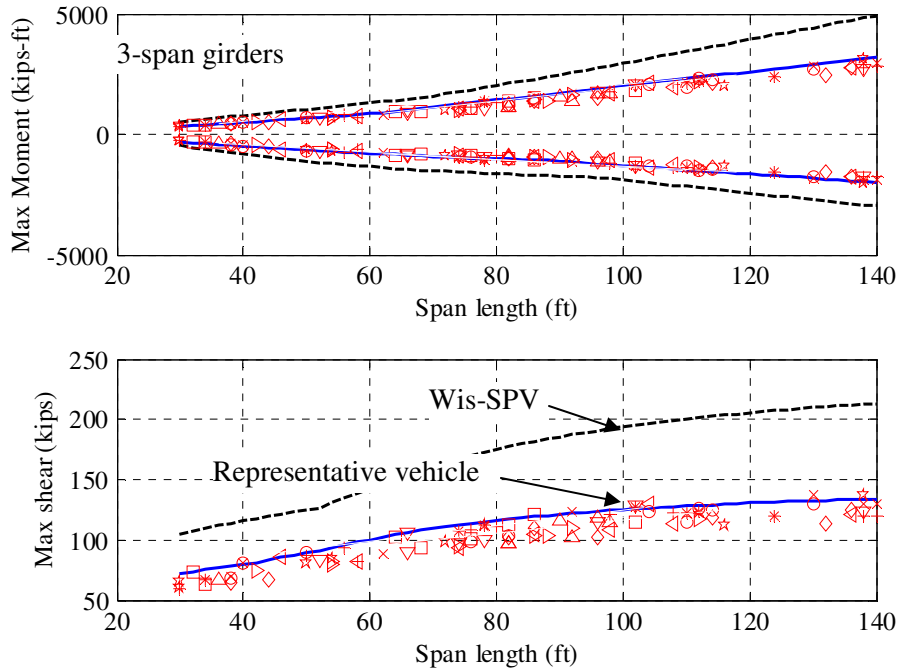

Fig. F.29 Comparison of randomly selected vehicles with the representative vehicle (Type 3S2)

The calculated responses for the randomly selected vehicles were divided by the responses of the representative vehicles for the selected span lengths to get the response ratios. The response ratios for the maximum positive moments, the maximum negative moments, and the maximum shear are shown in Fig. F.30, and the last bar chart in the figure shows the distribution of the total ratios. The mean ratios (μ) and the standard deviations (σ) are listed in Table F.6 and shown on the subfigures. Most distributions failed the Lilliefors normality tests, indicating that the randomly generated responses may not be modeled as a normal distribution. However, a normal distribution was shown in Fig. F.30 for comparison purposes.

Similarly, the response distributions of the vehicles in the entire class/group may not be modeled using a normal distribution using the sample mean ratio of μ and the sample standard deviation of σ listed in table F.6. However, normal distributions with the mean ratios of μ and the standard deviations of σ were assumed to describe the statistical characteristics of the vehicles of the entire class/group. An upper confidence bound (ucb in Fig. F.30) for each representative vehicle was calculated for each distribution as the cumulative distribution function corresponding to the response ratio of 1.0. The upper confidence bound indicates that ucb% of the vehicles within the top 5% gross vehicle weights in a class/group would cause girder responses less than that by the representative vehicles in the class/group. For example, the representative vehicle for Class 9 Type 3S2 vehicles had an upper confidence bound of 84.7%, indicating that the representative vehicle would envelop the positive moments by 84.7% vehicles in the top 5% of this class/group. Note that an optimization procedure may be used to modify the representative vehicles such that the obtained upper confidence bound for each representative vehicle can maintain constant.

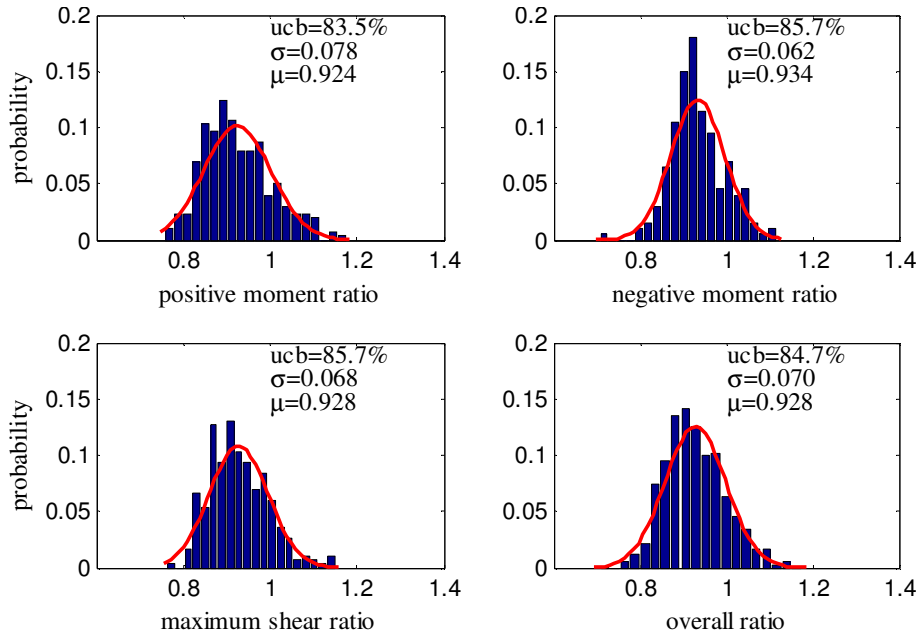

Fig. F.30 Statistical evaluation of the representative vehicle for Class 9 (Type 3S2)

Table F.6 summary of the statistical analysis of response ratios

Vehicles	Positive moments			Negative moments			Maximum shear		
	μ	σ	ucb	μ	σ	ucb	μ	σ	ucb
Class 4 2-axle	1.004	0.086	48.3	1.006	0.084	47.0	1.013	0.088	44.3
Class 4 3-axle	0.984	0.091	57.1	0.998	0.104	50.7	1.002	0.092	49.1
Class 5 2-axle	0.983	0.101	56.7	1.012	0.109	45.5	1.006	0.099	47.5
Class 6 3-axle	0.959	0.122	63.1	0.983	0.122	55.4	0.979	0.116	57.3
Class 7 4-axle	0.886	0.074	93.8	0.911	0.074	88.5	0.910	0.073	89.1
Class 7 5-axle	0.956	0.124	63.9	0.970	0.126	59.3	0.967	0.127	60.2
Class 8 3-axle	0.968	0.166	57.5	1.000	0.140	50.0	1.009	0.171	48.0
Class 8 4-axle a	0.885	0.122	82.7	0.962	0.138	60.8	0.919	0.126	74.1
Class 8 4-axle b	0.907	0.133	75.7	0.979	0.133	56.3	0.925	0.125	72.7
Class 9 5-axle a	0.924	0.078	83.5	0.934	0.062	85.7	0.928	0.068	85.7
Class 9 5-axle b	0.786	0.067	99.9	0.900	0.078	90.0	0.830	0.070	99.3
Class 10 6-axle	0.722	0.113	99.3	0.880	0.095	89.6	0.808	0.125	93.8
Class 10 7-axle	0.785	0.098	98.6	0.933	0.094	76.4	0.861	0.111	89.4
Class 11 5-axle	1.011	0.054	41.7	1.002	0.042	48.3	1.000	0.047	49.9
Class 12 6-axle	0.755	0.099	99.3	0.912	0.058	93.5	0.848	0.093	94.9
Class 13 7-axle a	0.662	0.147	98.9	0.847	0.203	77.5	0.745	0.158	94.7
Class 13 7-axle b	0.974	0.173	56.0	0.983	0.173	53.8	0.976	0.162	55.8
Class 14 5-axle	0.878	0.072	95.5	0.908	0.051	96.4	0.905	0.062	93.7

The mean response ratios and the corresponding standard deviations are not same for the girder internal forces (i.e., moments and shear). This indicates that some overloaded vehicles may cause large positive moments, and the others may cause large negative moments depending upon their configurations. To evaluate the representative vehicles, all responses ratios (including moment

and shear ratios) were used as shown in Table F.7. The mean ratios and the standard deviations for the combined samples were calculated similar to the analysis for individual internal forces. The upper confidence bound is similar to those listed in Table F.6. An ucb near 50% indicates that the representative vehicles properly represent the top 5% overweight vehicles. The upper confidence bounds near 90% indicate that the representative vehicles may overestimate the top 5% overweight vehicles.

Table F.7 Evaluation of the representative vehicles

Vehicle (Class/group)	μ	σ	ucb (%)	rep/spv (250 k)	poe (%)	# of vehicles	# of exceeds	rep/spv (190 k)	poe (%)	# of exceeds
Class 4 2-axle	1.008	0.086	46.4	0.393	0.0	21064	0	0.517	0.0	0
Class 4 3-axle	0.994	0.095	52.4	0.585	0.0	20351	0	0.770	0.0	0
Class 5 2-axle	0.999	0.103	50.4	0.431	0.0	20069	0	0.567	0.0	0
Class 6 3-axle	0.973	0.120	59.0	0.585	0.0	78523	0	0.770	0.3	13
Class 7 4-axle	0.901	0.075	90.7	0.783	0.0	15988	0	1.030	17.6	141
Class 7 5-axle	0.964	0.125	61.4	0.870	7.0	36234	126	1.145	76.5	1385
Class 8 3-axle	0.991	0.163	52.1	0.526	0.0	5789	0	0.693	0.3	1
Class 8 4-axle a	0.917	0.131	73.7	0.728	0.0	18469	0	0.958	16.5	153
Class 8 4-axle b	0.932	0.133	69.6	0.660	0.0	9813	0	0.868	4.9	24
Class 9 5-axle a	0.928	0.070	84.7	0.747	0.0	889230	0	0.983	10.2	4536
Class 9 5-axle b	0.831	0.083	97.9	0.906	0.1	133972	2	1.192	46.4	3106
Class 10 6-axle	0.794	0.129	94.4	1.082	15.8	27574	217	1.424	76.1	1049
Class 10 7-axle	0.851	0.117	89.9	1.198	55.3	2552	71	1.576	96.7	123
Class 11 5-axle	1.005	0.049	46.1	0.626	0.0	28618	0	0.824	0.0	0
Class 12 6-axle	0.829	0.108	94.3	0.879	0.2	11011	1	1.156	37.0	204
Class 13 7-axle a	0.739	0.181	92.5	1.112	18.8	1116	11	1.463	62.1	35
Class 13 7-axle b	0.977	0.169	55.4	0.875	16.4	3463	28	1.152	74.0	128
Class 14 5-axle	0.896	0.065	94.6	0.593	0.0	115	0	0.780	0.0	0

Within a certain class/group, vehicles with a smaller gross vehicle weight than the representative vehicle would cause smaller girder responses. Assuming a normal distribution for girder responses by various vehicles, the probability of exceeding (poe) was calculated for the Wis-SPV for each vehicle class/group. Similar to the calculation of the ucb values, a target response ratio (i.e. the inverse of the tabulated values of rep/spv in Table F.7) was needed for the probability of exceeding. This ratio was determined using the maximum moments/shear calculated for the representative vehicles listed in Tables F.3 through F.5 divided by the responses of the 250-kip Wis-SPV for various girders. Note that these response ratios were rather random; hence the maximum response ratios were used in the calculation of the probability of exceeding. Note that the probability of exceeding indicates that poe% of top 5% over weight vehicles are likely to cause larger girder responses than the Wis-SPV. Finally the estimated number of vehicles was calculated by multiply the poe% by 5% of the total number of the vehicles in the class/group (note that 2.5% was used for Class 9 vehicles). The total number of vehicles in each class/group is shown in the first cell in the table of the statistical characteristics of the vehicles class/group. In addition to the Class 10 and Class 13 vehicles, for which the representative vehicles caused larger positive moments as shown in Tables F.3 through F.5, significant number of Class 7 vehicles (with 6 axles) may exceed the 250-kip Wisconsin Standard Permit Vehicle. The random simulation for the Class 7 vehicles showed large variations. It is common that the exceeding probability increases with an increase in standard deviation as shown in Appendix 1. Meanwhile, the estimated situation may have reflected the real situation because Class 7 vehicles are short

single unit trucks: the representative is 26 ft long while has 113 kip gross weight. Hence, it is possible to create large positive moments, and sometimes large negative moments.

The total number of estimated vehicles (note that a vehicle may cause multiple records in the WIM data) was 456, which corresponding to 0.035% of total overweight vehicles (records). These vehicles were examined next to reveal their common features.

The gross weight distribution of the randomly selected vehicles that caused larger responses than the representative vehicles is shown in Fig. F.31. Sixteen vehicles (records) had a gross weight larger than 250 kips, and 266 vehicles (records) showed a gross weight larger than 170 kips. These heavy vehicles (records) took a slightly higher percentage than the actual data because a certain vehicle may be selected multiple times in the random process.

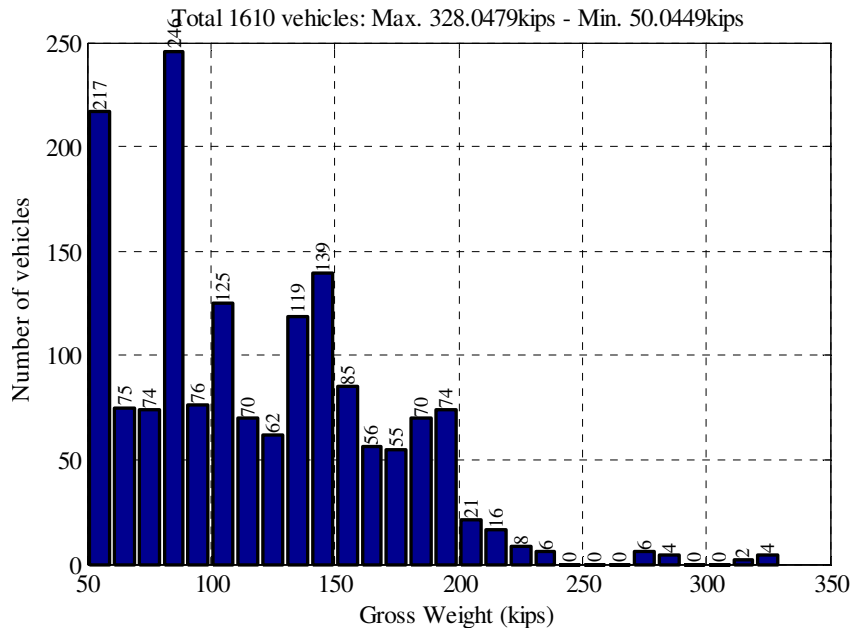

Fig. F.31 gross weight distribution of the randomly selected vehicles

Examination of randomly selected heavy vehicles

Fifty vehicles were randomly selected to conduct the above evaluation analysis for each representative vehicle on each simply-supported girder, resulting in 54 cases in total. Among the total 2,700 randomly selected vehicles in the 54 cases, 1,610 vehicles caused larger girder responses (i.e., positive moment, negative moment, or shear) than the representative vehicles. A close look at these vehicles indicated that the vehicle configurations were similar to the corresponding representative vehicles. Meanwhile almost all the 1,610 vehicles had a gross vehicle weight higher than the representative vehicles. In addition most axle spacings, especially the largest spacings were within the range of the variable spacings in the representative vehicles. This observation actually validated the methodology used in this study.

A list of heavy vehicles in each class/group was identified as shown in Fig. F.32 to demonstrate the worst cases in permit vehicles in Wisconsin. Almost all these vehicles have a gross weight larger than 80 kips except the 2-axle buses (trucks). Most vehicles have an outermost axle spacing less than the legal length: trucks less than 50 ft and vehicle combinations less than 75 ft. Most single axle weights are below 40 kips except for some Class 8 trucks with three axles, which have axle weights as large as 72 kips. The heavy rear axles actually reduced the load on the

steering axle such that the steering axle was only 1kip. This seemed unreasonable; however there was no obvious evidence that they were error in the WIM records. The heaviest steering axle is 38 kips in single unit trucks while the steering axle weights were smaller in semi-trailers and vehicle combinations.

Some Class 7 vehicles with 5 axles were particularly heavy (170 kips) and short, which would cause large girder responses in both positive moments and the negative moments. The worst Class 9 semi-trailers are slightly heavier than 170 kips, the upper limit for vehicles eligible for multi-trip permits. The worst Class 10 semi-trailers weighed close to 200 kips; hence they may need single-trip permits. Meanwhile, there were short vehicles in this class which might have been due to a wrong vehicle classification though their axle configurations followed the same pattern as the Type 3S3 and Type 3S4 vehicles. These short trucks were captured in the representative vehicles, which were the major contributors to the large girders responses. Two such trucks are shown in Fig. F.31 with 200-kip gross weight as the worst possible cases. The configuration of typical Type 3S2-2 vehicle combinations was not captured in the representative vehicles. This might have been due to the fact that Class 13 also includes non-divisible permit trucks/trailers, and the permit vehicles dominated the WIM records. Instead, the representative vehicles in Class 13 captured two typical non-divisible permit trucks/trailers as shown at the bottom of Fig. F.31.

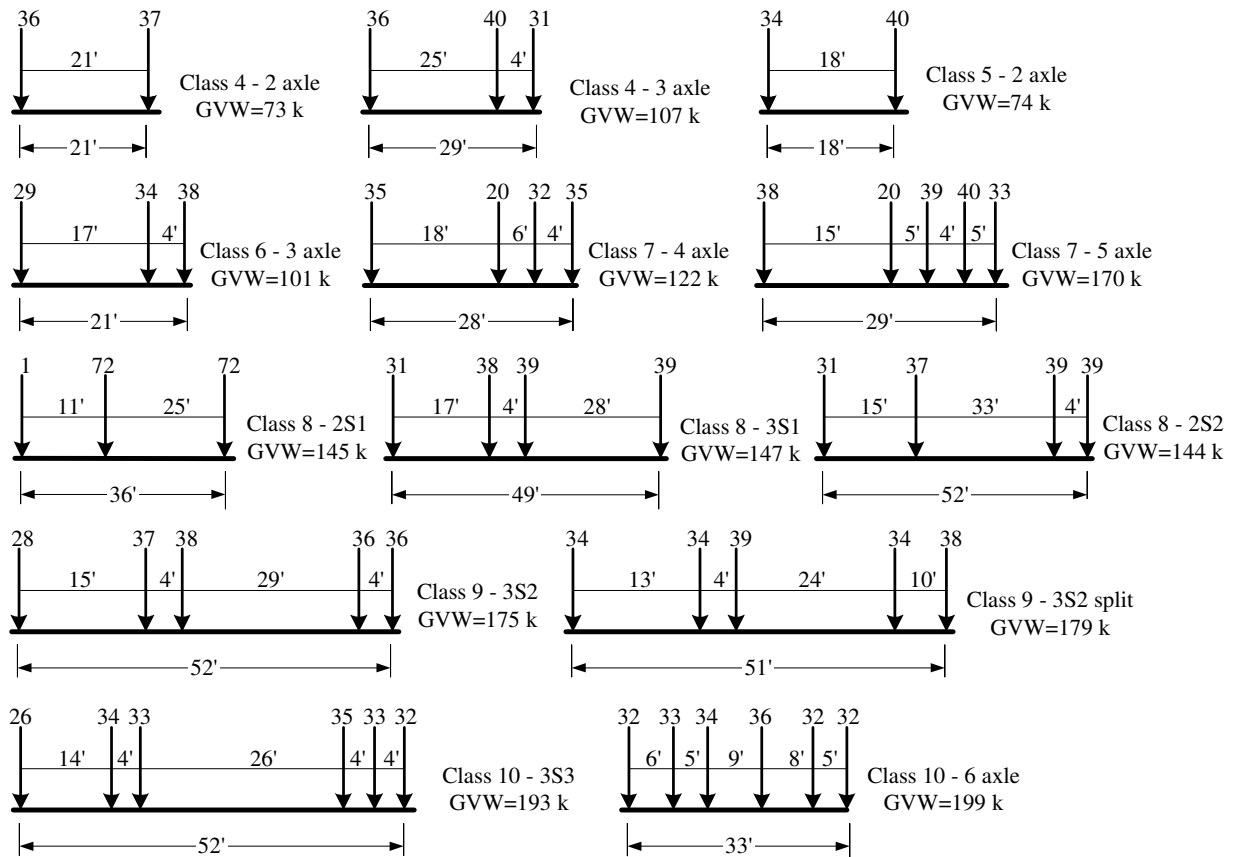

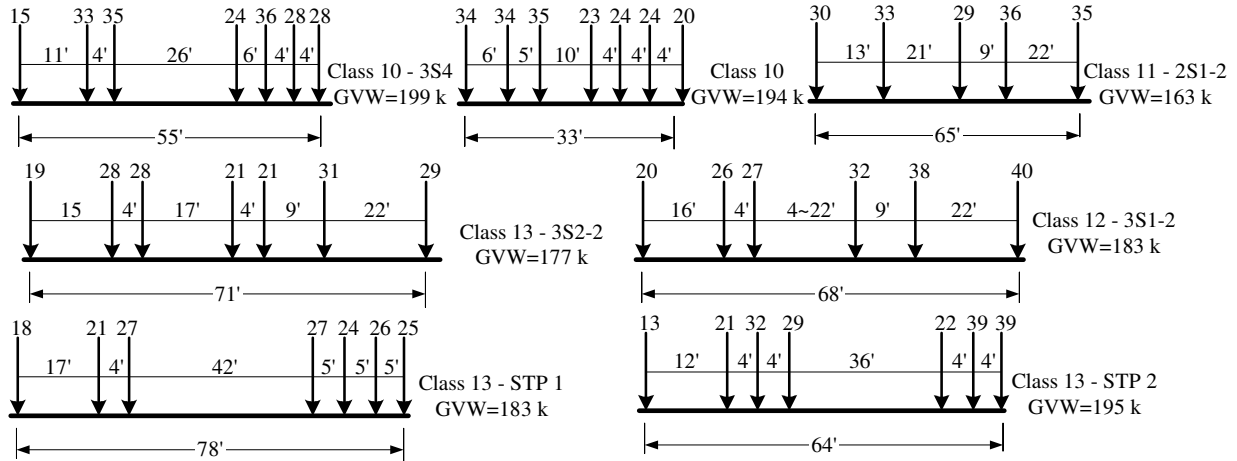
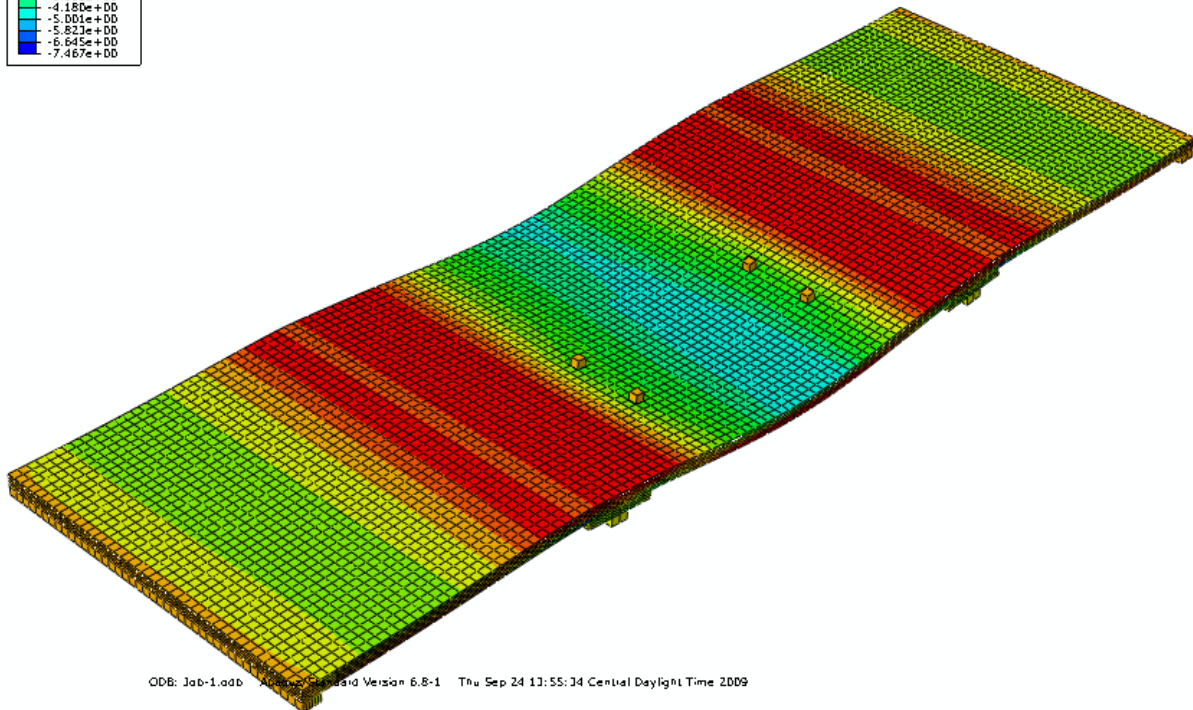
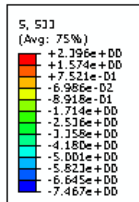

Fig. F.31 gross weight distribution of the randomly selected vehicles

These occasional overloads might cause damage to highway bridges,³⁷ especially on bridge decks.³⁸ Some exceptionally high axle loads were recorded in WIM data such as the Class 8 example (with two 72-kip axles) in Fig. F.31. Finite element analyses were conducted using ABAQUS[®] to investigate the potential local damage these high axle loads on bridge decks. The analysis results of a three-span slab bridge, which was used in Chapter 6 as permit rating example, are shown in Fig. F.32. The slab bridge was subjected to a group of two 72-kip axle loads at two locations. Normal stresses in the longitudinal direction are examined.



ODB: Job-1.odb Abaqus/CAE Version 6.8-1 Thu Sep 24 13:55:34 Central Daylight Time 2009

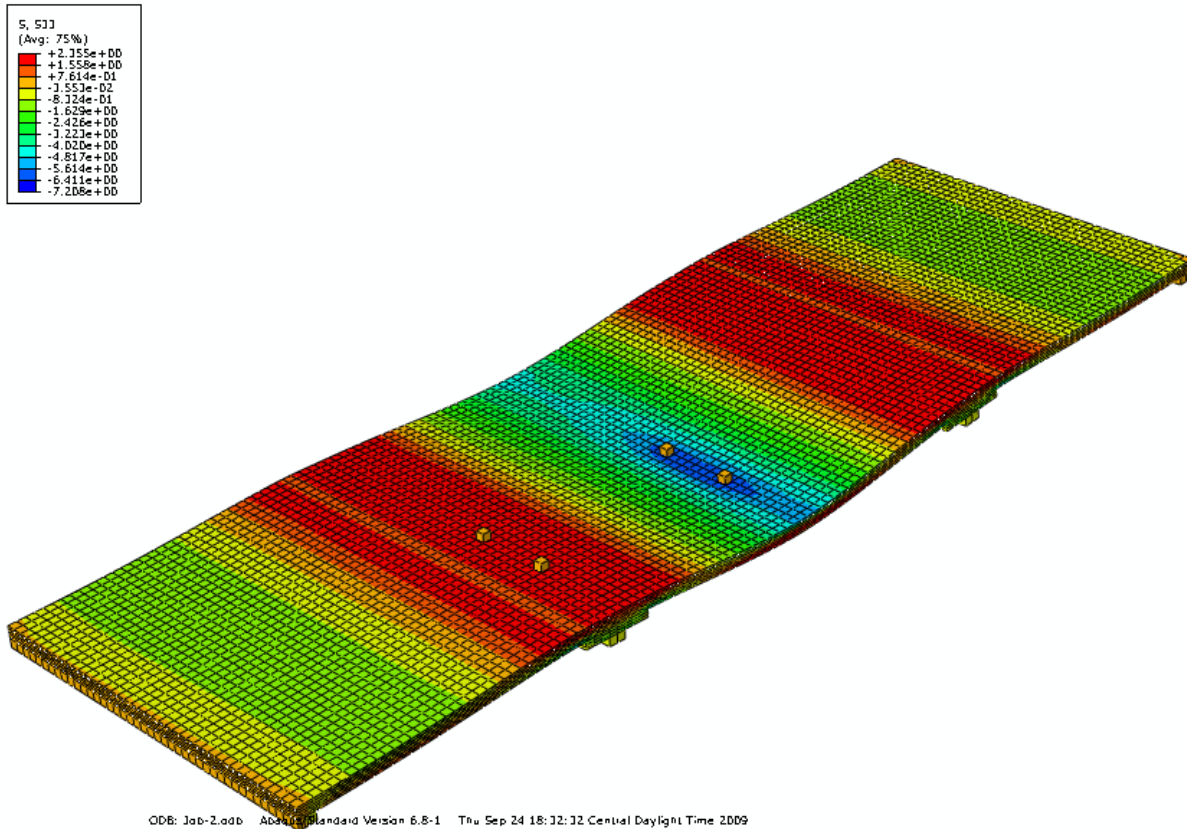

Fig. F.32 gross weight distribution of the randomly selected vehicles

In the model shown in Fig. F.32, concrete slab was modeled using solid brick element with nonlinear concrete material model considering plastic damage. Haunch plates were used near the interior supports to represent the real design. Steel reinforcements were embedded in concrete elements. Both the reinforcements and the nonlinear plastic damage concrete model facilitated the convergence of the analyses, in which the vehicle load, combined with the self weight, can cause concrete cracking near peak moments. The axle loads, applied to the slab through four rubber blocks, were placed at two locations to examine the potential local damage to the slab bridge. High stress concentration near the simulated tires was not observed in the analyzed two cases; however, the high axle loads did increase the normal stress distribution near the loads. Although the overloaded vehicle might have been considered in the design process, the increased stress may cause cracks, which may affect the durability of the bridge.

Summary

The weigh-in-motion records in Wisconsin in 2007 were used to evaluate the WisDOT Standard Permit Vehicle. The recorded vehicles (records) in individual classes per FHWA definitions were further divided into groups, in which the vehicles had similar configuration patterns. Descriptive statistical analyses were conducted for the vehicles in each class/group to define representative vehicles that best describe the vehicles with top 5% gross weights in that class/group. The representative vehicles were evaluated using randomly selected vehicles in the top 5% vehicles in the corresponding class/group. The girder responses by the randomly selected vehicles on the girders with randomly selected span lengths were used to estimate the probability that the heavy vehicles in each class/group might cause larger girder response than Wis-SPV.

The analysis indicated that 0.035% of total overweight vehicles (records) may exceed the 250-kip Wis-SPV. Meanwhile about 1% of vehicle potentially with permits would cause larger girder responses than the 190-kip Standard Permit Vehicle. A close examination of the selected overweight vehicles indicated that some short vehicles with 5 to 7 axles, currently on Wisconsin highway with annual permits, could generate severe bridge internal forces than the 250-kip Standard Permit Vehicle.