

# WISCONSIN TRUCK SIZE AND WEIGHT STUDY

Project 02-01  
June 2009

National Center for Freight & Infrastructure Research & Education  
College of Engineering  
Department of Civil and Environmental Engineering  
University of Wisconsin, Madison

*Authors:* Teresa M. Adams, Ph.D., Jason Bittner, Ernie Wittwer  
University of Wisconsin-Madison

*Principal Investigator:* Teresa M. Adams, Ph.D.  
Professor, Department of Civil and Environmental Engineering, University of Wisconsin-Madison



**Technical Report Documentation Page**

1. Report No. CFIRE 02-01	2. Government Accession No.	3. Recipient's Catalog No. <b>CFDA 20.701</b>	
4. Title and Subtitle  Wisconsin Truck Size and Weight Study		5. Report Date <b>June 2009</b>	
		6. Performing Organization Code	
7. Author/s Teresa M. Adams, Ph.D., Jason Bittner, and Ernie Wittwer		8. Performing Organization Report No. <b>CFIRE 02-01</b>	
9. Performing Organization Name and Address National Center for Freight and Infrastructure Research and Education (CFIRE) University of Wisconsin-Madison 1415 Engineering Drive, 2205 EH Madison, WI 53706		10. Work Unit No. (TRAIS)	
		11. Contract or Grant No. <b>0072-39-20</b>	
12. Sponsoring Organization Name and Address Wisconsin Department of Transportation 4802 Sheboygan Ave Madison, WI 53707		13. Type of Report and Period Covered <b>Final Report [6/15/08 – 6/30/09]</b>	
		14. Sponsoring Agency Code	
15. Supplementary Notes <b>Project completed for the Wisconsin Department of Transportation.</b>			
16. Abstract  2007 AB 238 requires the Department of Transportation to conduct a comprehensive study to review the system of motor vehicle weight limits on Wisconsin's highways and bridges. Laws regarding allowable weight limits, lengths, and widths of commercial motor vehicles are designed to ensure safe vehicle operation on Wisconsin's roadways and to preserve the state's investment in highway and bridge infrastructure. Federal laws govern limits on the Interstates and other selected state highways. Truck size and weight laws affect the cost of transportation for Wisconsin's freight shippers and carriers. At the same time, studies have documented the impacts of heavily loaded and overloaded trucks on pavement surfaces and bridge structures. In light of changing patterns of economic growth and logistics, continued increases in truck traffic, and numerous requests for changes to laws, it has become apparent that a comprehensive review of Wisconsin's state TS&W laws is needed.			
17. Key Words Trucking, size, weight, restrictions, Wisconsin		18. Distribution Statement <b>No restrictions. This report is available through the Transportation Research Information Services of the National Transportation Library.</b>	
19. Security Classification (of this report) <b>Unclassified</b>	20. Security Classification (of this page) <b>Unclassified</b>	21. No. Of Pages 295	22. Price <b>-0-</b>

## **DISCLAIMER**

This research was funded by the Wisconsin Department of Transportation through the National Center for Freight and Infrastructure Research and Education at the University of Wisconsin-Madison. The contents of this report reflect the views of the authors, who are responsible for the facts and the accuracy of the information presented herein. This document is disseminated under the sponsorship of the Department of Transportation, University Transportation Centers Program, in the interest of information exchange. The U.S. Government assumes no liability for the contents or use thereof. The contents do not necessarily reflect the official views of the National Center for Freight and Infrastructure Research and Education, the University of Wisconsin, the Wisconsin Department of Transportation, or the USDOT's RITA at the time of publication.

The United States Government assumes no liability for its contents or use thereof. This report does not constitute a standard, specification, or regulation.

The United States Government does not endorse products or manufacturers. Trade and manufacturers names appear in this report only because they are considered essential to the object of the document.



# Wisconsin TRUCK SIZE AND WEIGHT STUDY



June 15, 2009

*prepared for*

Wisconsin Department of Transportation

*prepared by*

Cambridge Systematics, Inc.

*with*

National Center for Freight and Infrastructure  
Research and Education (CFIRE) at the  
University of Wisconsin-Madison

*and*

Harry Cohen

Woodrooffe Dynamics, LLC

Stetenfeld Associates, LLC

Earth Tech/AECOM

Prime Focus, LLC

TranSmart Technologies, Inc.

Abrazo Multicultural Marketing & Communication

Wisconsin Traffic Operations and Safety Laboratory (TOPS)  
at the University of Wisconsin-Madison



*final report*

# Wisconsin Truck Size and Weight Study

*prepared for*

Wisconsin Department of Transportation

*Prepared by*

Cambridge Systematics, Inc.

*with*

National Center for Freight and Infrastructure Research and Education (CFIRE)  
at the University of Wisconsin-Madison

*and*

Harry Cohen  
Woodrooffe Dynamics, LLC  
Stetenfeld Associates, LLC  
Earth Tech/AECOM  
Prime Focus, LLC  
TranSmart Technologies, Inc.  
Abrazo Multicultural Marketing & Communication  
Wisconsin Traffic Operations and Safety Laboratory (TOPS) at the University of  
Wisconsin-Madison

*date*

June 15, 2009

# Table of Contents

<b>Executive Summary .....</b>	<b>ES-1</b>
Introduction .....	ES-1
Background – Wisconsin’s Freight Challenge .....	ES-2
Issues and Considerations .....	ES-3
Project Approach.....	ES-8
Key Findings .....	ES-9
Policy Directions and Next Steps.....	ES-18
Policy Implementation Guidance .....	ES-19
Performance Measurement.....	ES-21
<b>1.0 Scope, Limits, and Administration of Existing Truck Size and Weight Laws in Wisconsin.....</b>	<b>1-1</b>
1.1 Summary .....	1-1
1.2 Methodology .....	1-2
1.3 Findings.....	1-2
1.4 Conclusions.....	1-25
1.5 Appendix 1A – Definitions.....	1-25
1.6 Appendix 1B – Wisconsin National Network Roadways.....	1-26
<b>2.0 Selected Truck Size and Weight Laws in Neighboring States.....</b>	<b>2-1</b>
2.1 Summary .....	2-1
2.2 Methodology .....	2-2
2.3 Findings.....	2-3
2.4 Minnesota.....	2-11
2.5 Iowa .....	2-16
2.6 Illinois .....	2-18
2.7 Indiana.....	2-21
2.8 Michigan.....	2-23
<b>3.0 Heavy Truck Equipment, Configuration, and Technology Trends .....</b>	<b>3-1</b>
3.1 Summary .....	3-1
3.2 Heavy Truck Equipment and Technology Trends .....	3-2
3.3 Trends of Original Equipment Manufacturers.....	3-9
3.4 Conclusions.....	3-10
<b>4.0 Review of Changing Business Practices and Economic Forces.....</b>	<b>4-1</b>
4.1 Methodology .....	4-1

4.2	System Performance .....	4-2
4.3	Trends Impacting Freight Movements .....	4-4
4.4	Overview of Wisconsin Commodities .....	4-10
4.5	Geographic Distribution of Freight Generation .....	4-13
4.6	Business Practices and Geographic Characteristics of Heavy Hauling Industries .....	4-15
4.7	Conclusions.....	4-39
<b>5.0</b>	<b>Wisconsin Large Truck Crash Trends.....</b>	<b>5-1</b>
5.1	Summary .....	5-1
5.2	Methodology .....	5-1
5.3	Findings.....	5-2
<b>6.0</b>	<b>Potential Changes to TSW Laws and Practices .....</b>	<b>6-1</b>
6.1	Summary .....	6-1
6.2	Configurations for Review .....	6-1
6.3	Potential Policy Recommendations.....	6-8
<b>7.0</b>	<b>Truck Size and Weight Impact Analysis Methodology .....</b>	<b>7-1</b>
7.1	Introduction .....	7-1
7.2	Truck Usage .....	7-2
7.3	Goods Movement Costs.....	7-3
7.4	Pavements and Bridge Decks.....	7-4
7.5	Bridge Reconstruction, Rehabilitation, and Posting Costs .....	7-7
7.6	Safety .....	7-19
7.7	Congestion .....	7-20
7.8	Energy and the Environment.....	7-21
<b>8.0</b>	<b>Results and Recommendations .....</b>	<b>8-1</b>
8.1	Summary .....	8-1
8.2	Configuration Analysis.....	8-1
8.3	Impact of Interstate System Restrictions .....	8-13
8.4	Policy Directions and Options .....	8-15
<b>9.0</b>	<b>Wisconsin TSW Policy Implementation Guidance.....</b>	<b>9-1</b>
9.1	Overview .....	9-1
9.2	Oversize/Overweight Permitting Procedures .....	9-1
9.3	Safety and Weight Enforcement Facility (SWEF) Inspection Technologies .....	9-6
9.4	Commercial Vehicle Information Systems and Networks (CVISN) .....	9-10

<b>10.0</b>	<b>Performance Measures and Devices for Keeping Rules Current</b>	<b>10-1</b>
10.1	Introduction	10-1
10.2	Overview	10-2
10.3	Objectives of Moving Freight	10-3
10.4	Listening to the Industry	10-6
10.5	Agency Organization	10-8
10.6	Performance-Based Standards in Other Countries	10-14
10.7	Responding to Reasonable Exceptions	10-17
10.8	Summary of Recommendations	10-20
10.9	Actions Taken	10-21
10.10	Bibliography	10-22
10.11	Interviews	10-23
<b>A.</b>	<b>Private Sector Outreach Findings</b>	<b>A-1</b>
A.1	Overview	A-1
A.2	Participation	A-2
A.3	Summary	A-3
A.4	Motor Carrier Representatives	A-5
A.5	Specialized Oversize and Overweight Motor Carrier Representatives	A-7
A.6	Forest Products (Logs and Mills) Representatives	A-9
A.7	Milk Hauler Representatives	A-11
A.8	Scrap Representatives	A-12
A.9	Agricultural-Ethanol Representatives	A-14
A.10	Agricultural Products Representatives	A-15
A.11	Paper/Printing Industry Representatives	A-16
A.12	Mining Products Representatives	A-17
A.13	Consumer Products Manufacturing Representative	A-18
A.14	Brewery Representatives	A-19
<b>B.</b>	<b>Public Agency Outreach Findings</b>	<b>B-1</b>
B.1	Summary	B-1
B.2	Impact of Truck Size and Weight Laws Today	B-2
B.3	Potential Changes to TSW Laws	B-4
B.4	Potential Impacts of Change	B-5
B.5	Other Solutions	B-5
<b>C.</b>	<b>Performance-Based Evaluation of Selected Vehicles</b>	<b>C-1</b>
C.1	Introduction	C-1
C.2	Candidate Vehicles	C-1

**D. Study Advisory Group Commentary .....D-1**

D.1 Overview ..... D-1

D.2 Commentary from AAA Wisconsin..... D-2

D.3 Commentary from State Representative Mark Gottlieb ..... D-3

D.4 Commentary from the Great Lakes Timber Professionals  
Association..... D-4

D.5 Commentary from the Wisconsin County Highway Association,  
Wisconsin Counties Association, Wisconsin Towns Association,  
and Wisconsin League of Municipalities ..... D-5

# List of Tables

Table ES.1 Guiding Principles.....	ES-8
Table ES.2 Public Agency Outreach Key Findings .....	ES-10
Table ES.3 Private Sector Outreach Key Findings .....	ES-10
Table ES.4 Annual Costs and Benefits for Candidate Configurations <i>Operating on Non-Interstate Highways Only</i> .....	ES-12
Table ES.5 Annual Costs and Benefits for Candidate Configurations <i>Assuming Interstate Operation Is Allowable</i> .....	ES-12
Table ES.6 Annual Fuel and Emissions Reductions for Candidate Configurations .....	ES-15
Table 1.1 Locations of Safety and Weight Enforcement Facilities.....	1-12
Table 1.2 Load-Specific Exceptions in Wisconsin Law .....	1-15
Table 1.3 Wisconsin National Network Roadways.....	1-27
Table 2.1 Summary of Maximum Dimensions in Wisconsin and Neighboring States .....	2-4
Table 2.2 Summary of Maximum Commercial Vehicle Weights in Wisconsin and Neighboring States .....	2-4
Table 2.3 Summary of Permitting Practices for Commercial Vehicle Weights in Wisconsin and Neighboring States.....	2-6
Table 2.4 Load-Specific Exceptions by State.....	2-7
Table 2.5 2007 State Program Measures Summary.....	2-10
Table 2.6 Minnesota Weight Limits by Roadway Class .....	2-12
Table 2.7 Oversize/Overweight Permit Standards for Iowa .....	2-17
Table 3.1 Smart Bridge Technologies .....	3-2
Table 4.1 Truck Haul Lengths Originating in Wisconsin by Value and Tonnage.....	4-2
Table 4.2 Shipment Characteristics by Total Modal Activity for State of Origin 2002 .....	4-3
Table 4.3 Wisconsin's Top 5 International Export Markets 2007 .....	4-3
Table 4.4 2001 Wisconsin Commodity Transport by Tonnage (All Modes)....	4-10
Table 4.5 2001 Top Wisconsin Commodities (Truck Only).....	4-11

Table 4.6	Wisconsin’s Top Commodities by Tonnage; Within, Export, and Import.....	4-12
Table 4.7	Wisconsin’s Top Manufacturing Export Commodities by Value ....	4-13
Table 4.8	Top 10 Wisconsin Counties – Originating Truck Tonnage 2001 .....	4-14
Table 4.9	Top 10 Wisconsin Counties – Terminating Truck Tonnage 2001 .....	4-14
Table 4.10	Major Wisconsin Forest Products Processing Facilities .....	4-16
Table 4.11	Wisconsin’s Top 10 Originating Counties for the Transportation of Lumber and Wood Products 2001 .....	4-17
Table 4.12	Wisconsin’s Top 10 Origin/Destination County Pairs for the Transportation of Lumber and Wood Products 2001.....	4-17
Table 4.13	Wisconsin’s Top 10 Originating Counties for the Transportation of Paper and Pulp 2001 .....	4-20
Table 4.14	Wisconsin’s Top 10 Origin/Destination County Pairs for the Transportation of Paper and Pulp 2001.....	4-20
Table 4.15	Wisconsin’s Top 10 Originating Counties for the Transportation of Machinery 2001 .....	4-21
Table 4.16	Wisconsin’s Top 10 Origin/Destination County Pairs for the Transportation of Machinery 2001 .....	4-22
Table 4.17	Wisconsin’s Top Agricultural Commodities <i>by Dollar Value</i> .....	4-23
Table 4.18	Wisconsin Farms by Economic Sales Class 2006 to 2007 .....	4-25
Table 5.1	Wisconsin Total Crashes, Fatalities and VMT 1996 to 2006.....	5-4
Table 6.1	Six-Axle 90,000 Pound Semi.....	6-2
Table 6.2	Seven-Axle 97,000 Pound Semi .....	6-3
Table 6.3	Seven-Axle 80,000 Pound Single-Unit (45-foot length).....	6-4
Table 6.4	Eight-Axle 108,000 Pound Twin.....	6-5
Table 6.5	Six-Axle 98,000 Pound Semi.....	6-6
Table 6.6	Six-Axle 98,000-Pound Straight Truck plus Pup Trailer.....	6-7
Table 7.1	Basis for Estimating Equivalent Single-Axle Load (ESAL) Factors .....	7-7
Table 7.2	Estimated Annual Bridge Replacement Costs .....	7-17
Table 7.3	Unit Costs of Medium- and Heavy-Truck Crashes 2008 Dollars .....	7-20
Table 8.1	Annual Costs and Benefits for Candidate Configurations Operating on Non-Interstate Highways Only .....	8-4
Table 8.2	Annual Transport Cost Savings .....	8-5



Table 8.3	Annual Fuel and Emissions Reductions for Candidate Configurations .....	8-5
Table 8.4	Annual Changes in VMT Based on Diversion to Candidate Configurations .....	8-6
Table 8.5	Annual Pavement Cost Savings for Candidate Configurations .....	8-7
Table 8.6	Annual Costs and Benefits for Candidate Configurations <i>Assuming 20 Percent Shift of Freight from Interstate to Non-Interstate</i> .....	8-7
Table 8.7	Annual Costs and Benefits for Candidate Configurations <i>Assuming No Shift of Freight from Interstate to Non-Interstate</i> .....	8-8
Table 8.8	Annual Costs and Benefits for Candidate Configurations <i>Assuming Double the Amount of Diversion to Configurations</i> .....	8-8
Table 8.9	Annual Costs and Benefits for Candidate Configurations <i>Assuming One-Half the Amount of Diversion to Configurations</i> .....	8-9
Table 8.10	Annual Costs and Benefits for Candidate Configurations <i>Without Dollar Values Associated With Pain and Suffering</i> .....	8-9
Table 8.11	Annual Costs and Benefits for Candidate Configurations <i>With No Pavement Expenditure Reduction</i> .....	8-10
Table 8.12	Annual Costs and Benefits for Candidate Configurations <i>with Reduced Diesel Fuel Price of \$2.05</i> .....	8-11
Table 8.13	Annual Costs and Benefits for Candidate Configurations <i>with Increased Diesel Fuel Price of \$4.77</i> .....	8-11
Table 8.14	Annual Costs and Benefits for Candidate Configurations <i>Assuming Trucks are Powered by 20 Percent Bio-Diesel</i> .....	8-12
Table 8.15	Annual Costs and Benefits for Candidate Configurations <i>Assuming Interstate Operation is Allowable</i> .....	8-14
Table 8.16	Changes in VMT for Non-Interstate versus All Highways Scenarios .....	8-15
Table 10.1	Performance-Based Standards .....	10-15
Table 10.2	Safety Performance-Based Standards and Thresholds .....	10-16
Table A.1	Private Sector Outreach Key Findings .....	A-4
Table B.1	Public Agency Outreach Key Findings .....	B-2
Table C.1	Performance Measures for the Six- and Seven-Axle Tractor Semitrailer .....	C-10
Table C.2	Performance Measures for the Eight-Axle Double Configured as A- and B-Trains .....	C-10



# List of Figures

Figure ES.1	Balancing Truck Productivity .....	ES-1
Figure ES.2	Wisconsin Fatal Crash Rates by Vehicle Type 1984 to 2007 .....	ES-6
Figure ES.3	Wisconsin Crash Rates by Vehicle Type 1984 to 2007 .....	ES-7
Figure 1.1	Truck Size Limits .....	1-3
Figure 1.2	FHWA Bridge Formula Weights Calculator .....	1-8
Figure 1.3	Locations of Safety and Weight Enforcement Facilities.....	1-11
Figure 1.4	Wisconsin Permitting Process Overview .....	1-13
Figure 1.5	2008 Wisconsin Long Truck Operators Map .....	1-19
Figure 2.1	Selected States for Truck Size and Weight Review .....	2-3
Figure 2.2	Relative Permit Costs .....	2-8
Figure 2.3	Comparison of Overweight Fines .....	2-9
Figure 2.4	Current Out of Service Orders.....	2-11
Figure 2.5	MnDOT Gross Weight Schedule .....	2-13
Figure 2.6	Illinois Maximum Truck Configuration and Weight by Roadway Class.....	2-19
Figure 2.7	Michigan Five-Axle, 87,400 Pound Combination .....	2-24
Figure 2.8	Michigan Six-Axle 101,400 Pound Combination .....	2-24
Figure 4.1	Average Weekly Midwest Diesel Retail Sales <i>September 1994 to September 2008</i> .....	4-4
Figure 4.2	Wisconsin's Distribution Centers by Location.....	4-8
Figure 4.3	Wisconsin Forest Products Facilities .....	4-15
Figure 4.4	Paper Mills in Wisconsin.....	4-19
Figure 4.5	Farms in Wisconsin by County .....	4-24
Figure 4.6	Tons of Wisconsin Corn for Silage Production <i>by County</i> .....	4-26
Figure 4.7	Wisconsin Hay and Other Silage Production (Dry Tons).....	4-27
Figure 4.8	Wisconsin Location of Milk Cows <i>by Head</i> .....	4-29
Figure 4.9	Wisconsin Oats Production (Tons) .....	4-30
Figure 4.10	Wisconsin Potatoes Production <i>In Tons</i> .....	4-32
Figure 4.11	Wisconsin Soybean Production (Tons).....	4-33

Figure 4.12	Wisconsin Wheat Production (Tons) .....	4-34
Figure 4.13	Wisconsin Foundries .....	4-36
Figure 4.14	Wisconsin Wind Farms .....	4-38
Figure 5.1	U.S. Large Truck Crash Rate Trends .....	5-2
Figure 5.2	U.S. Passenger Car, Light Truck, and Motorcycle Crash Rate Trends.....	5-3
Figure 5.3	Wisconsin Large Truck Crashes .....	5-4
Figure 5.4	Wisconsin Crash Rates by Vehicle Type 1984 to 2007 .....	5-5
Figure 5.5	Wisconsin Fatal Crash Rates by Vehicle Type 1984 to 2007 .....	5-6
Figure 5.6	Large Truck Crashes by County 2006.....	5-7
Figure 5.7	Large Truck Crash Rates by County 2006.....	5-9
Figure 6.1	Axle Spacings and Weights.....	6-2
Figure 6.2	Axle Spacings and Weights.....	6-3
Figure 6.3	Axle Spacings and Weights.....	6-4
Figure 6.4	Axle Spacings and Weights .....	6-5
Figure 6.5	Axle Spacings and Weights.....	6-6
Figure 6.6	Axle Spacings and Weights.....	6-7
Figure 7.1	Effect of Pavement Condition on Road User Costs for Low-Volume Roads .....	7-6
Figure 7.2	Effect of Congestion on Average Speed Six-Lane Freeway With 6+ Foot Shoulders .....	7-21
Figure 9.1	Western Permit Program States.....	9-2
Figure 9.2	Virtual Weigh Station Transponder and In-Vehicle Computer.....	9-8
Figure 10.1	Inventory and Transportation Costs.....	10-4
Figure 10.2	Wisconsin DOT Organizational Structure .....	10-9
Figure 10.3	Missouri DOT Multimodal Organizational Structure.....	10-10
Figure 10.4	Maryland DOT Logistics Office Home Page .....	10-13
Figure C.1	Illustration of B-Train Trailer-to-Trailer Coupling .....	C-2
Figure C.2	Illustration of A-Train Trailer-to-Trailer Coupling .....	C-2
Figure C.3	Six-Axle Tractor Semitrailer with GVW 90,000 Pounds .....	C-3
Figure C.4	Six-Axle Tractor Semitrailer with GVW 98,000 Pounds .....	C-3

Figure C.5 Seven-Axle Tractor-Trailer Utilizing a Four-Axle Tractor with  
GVW 97,000 Pounds..... C-3

Figure C.6 Eight-Axle B-Train with GVW 108,000 Pounds ..... C-4

Figure C.7 Seven-Axle Straight Truck with GVW 80,000 Pounds with Self-  
Steering Axles at Locations 2, 3, and 4 ..... C-4

Figure C.8 Seven-Axle Straight Truck with GVW 80,000 Pounds with Self-  
Steering Axles at Locations 2, 3, 4, and 7 ..... C-4

Figure C.9 Six-Axle Straight Truck and Trailer with GVW 98,000 Pounds..... C-5

Figure C.10 Illustration of Rollover Initiation ..... C-6

Figure C.11 Rearward Amplification of Lateral Acceleration..... C-7

Figure C.12 Low-Speed Offtracking ..... C-8

Figure C.13 High-Speed Offtracking ..... C-9

Figure C.14 Comparison of Static Rollover Threshold for All Vehicles ..... C-11

Figure C.15 Comparison of Load Transfer Ratio for All Vehicles ..... C-12

Figure C.16 Comparison of Rearward Amplification for All Vehicles ..... C-13

Figure C.17 Comparison of High-Speed Transient Offtracking for All  
Vehicles ..... C-14

Figure C.18 Comparison of High-Speed Offtracking for All Vehicles..... C-15

Figure C.19 Comparison of Low-Speed Offtracking for All Vehicles..... C-15

Figure C.20 Comparison High-Speed Friction Utilization for All Vehicles... C-16



# Executive Summary

## INTRODUCTION

This report summarizes the approach, findings, and recommendations of the Wisconsin Truck Size and Weight (TSW) study led by the Wisconsin Department of Transportation (WisDOT) in cooperation with other public and private stakeholders. The purpose of the project is to assess potential changes in Wisconsin's TSW laws that would benefit the Wisconsin economy while protecting roadway and bridge infrastructure and maintaining safety. Changes to commercial vehicle configurations and policies have the potential to provide productivity gains that could strengthen Wisconsin industries against increasing domestic and international competition. The broad challenge of this evaluation is the ability of the TSW changes to balance economic gains resulting from increased truck productivity with the potential costs to safety and infrastructure (illustrated in Figure ES.1).

**Figure ES.1 Balancing Truck Productivity**

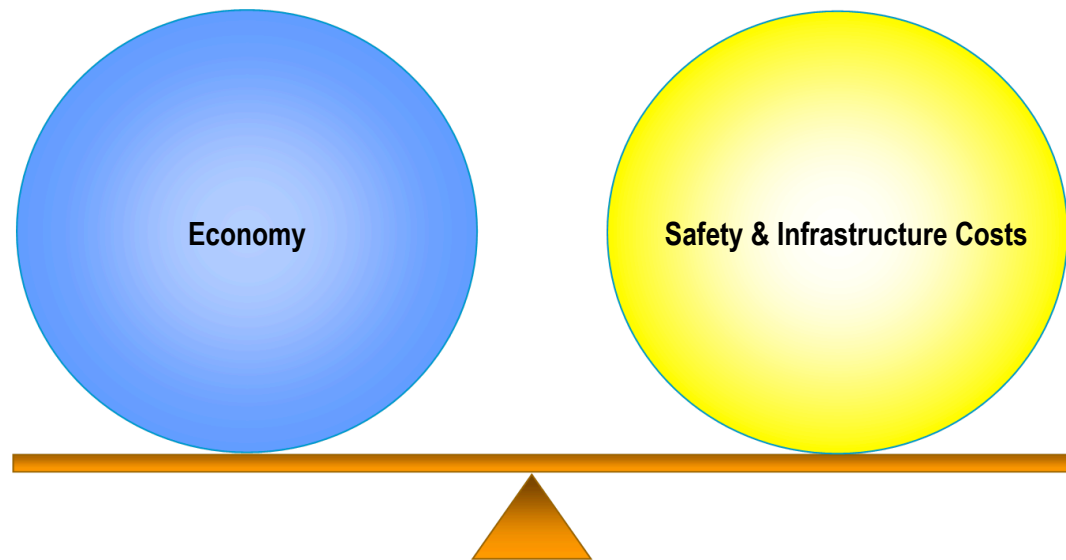

In response to this challenge, this study seeks to answer three fundamental questions:

1. Should changes be made to Wisconsin's TSW laws?
2. What impacts would changes to TSW laws have on the State's roads and bridges, regulatory and enforcement capabilities, administrative processes, and freight transportation modes?
3. What specific requirements need to be met by any vehicles operating under modified size/weight standards?

Through an extensive outreach program, research, and analysis, this study presents the answers to these questions and provides Wisconsin with potential policy directions and actions to enhance freight productivity, safety, and program efficacy.

## **BACKGROUND – WISCONSIN’S FREIGHT CHALLENGE**

Wisconsin’s industries and economy depend on an efficient multimodal transportation network to move goods reliably and cost-effectively. The State’s industries ship over \$300 billion in goods annually over the Wisconsin transportation network. The system has accommodated significant growth in freight demand over the last few decades and will face continued growth in the future – an additional 70 percent through 2025. This forecast growth will challenge the ability of the Wisconsin multimodal system to accommodate increased volumes without capacity expansion or other productivity gains that will allow more freight to move over the current network. To assist the State in confronting this gap between available infrastructure and predicted freight demand, this study seeks to examine other ways to meet this freight challenge through the potential introduction of more productive commercial vehicles and policies that support freight growth.

Of the four freight modes (rail, water, truck, and air), the trucking industry is growing at the highest rate nationally and in Wisconsin. Exact percentages differ depending on the source data, but it is expected that the trucking-related share of freight movements will continue to increase. According to the 2002 Commodity Flow Survey, 74 percent of total Wisconsin freight tonnage is carried by truck. Truck ton-miles represent just under one-half of the total ton-miles of goods movements with an average truck trip length of 183 miles. As expected, other modes have significantly longer average trip lengths within, exported from, and imported to Wisconsin.

Increasing transportation costs, especially with respect to fluctuating diesel prices, multimodal capacity constraints, international competition, changes in rail services, and a shift to containerized shipments are driving businesses to seek additional productivity gains from the freight transportation system in the State of Wisconsin. An integrated network of more efficient freight facilities and services for highway, rail, water, and air is needed to enhance Wisconsin’s competitiveness, including access to markets outside the State. Rail cars and marine vessels have generally gotten heavier over the last 25 years whereas trucking size and weights have been held relatively constant over that period by Federal law, resulting in recent pressures for changes at both the state and national level.

The agricultural, paper, foundry, forestry, and manufacturing industries of Wisconsin are especially vulnerable to regional and international competition. These industries are also currently weight constrained in truck movements. Many of the industries, most notably sand and gravel shipments, are very low



value but require significant tonnage on the roadway network. Overall, these and other industries could realize economic benefits from modified weight restrictions.

At the same time, comprehensive regulation of truck size and weights requires a balance between economic competitiveness and the principal goals of state and local transportation agencies, including infrastructure preservation and promotion of public safety. These agencies rely upon a system of truck size and weight regulations and enforcement of these regulations through the Wisconsin State Patrol and local enforcement corps. Oversize and overweight permits, issued through both local and county agencies as well as WisDOT, accommodate industry needs and allow for the flexibility to accommodate economic growth.

In response to these changing industry and agency needs, Wisconsin lawmakers have recently considered several proposals to change TSW laws. A number of these legislative proposals tailored to specific industry needs have been enacted, demonstrating the need for a more comprehensive approach to future TSW changes that consider economic, infrastructure, safety, and other impacts. As a result, the Wisconsin Legislature formed a Special Committee on Highway Weight Limits which reviewed the issue and sponsored Assembly Bill 238, passed as Wisconsin Act 20 in October of 2007. Act 20 called for the Wisconsin Department of Transportation to study vehicle truck size and weight limits through this study.

Despite the recent legislative action, WisDOT has historically opposed legislation allowing heavier trucks in recognition of the higher public investments necessary to accommodate those heavier vehicles.

## **ISSUES AND CONSIDERATIONS**

### **Industry Challenges and Considerations**

Wisconsin operates in a global economy, and competes especially with states in the Upper Midwest and with Canada. Several of these jurisdictions have higher weight limits than Wisconsin, potentially putting Wisconsin's industries at a competitive disadvantage. For example, Michigan allows operation of heavier and longer trucks, even on their Interstate system through "grandfather" provisions in Federal law. TSW limits affect freight transportation costs because they control the amount of payload that can be carried in a truck. Increases in truck weight limits increase the allowable weight per trip, so fewer trips are required to carry the same amount of goods. Freight transportation cost savings due to increases in TSW limits accrue to shippers, carriers, and consumers.

### **Pavement Considerations**

Engineers design roads to accommodate projected vehicle loads, in particular, heavy vehicle axle loads. The life of a pavement is related to the magnitude and frequency of these heavy axle loads. Pavement engineers use the concept of an equivalent single-axle load (ESAL) to measure the effects of heavy vehicles on

pavements.<sup>1</sup> Any truck axle configuration and weight can be converted to this common unit of measure. Adding axles to a truck can greatly reduce the impact on pavement. A conventional five-axle tractor-semitrailer operating at 80,000 pounds gross vehicle weight (GVW) is equivalent to about 2.4 ESALs. If the weight of this vehicle were increased to 90,000 pounds (a 12.5 percent increase), its ESAL value goes up to 4.1 (a 70.8 percent increase), because pavement damage increases at a geometric rate with weight increases. However, a six-axle tractor-semitrailer at 90,000 pounds has an ESAL value of only 2.0, because its weight is distributed over six axles instead of five. An added pavement benefit of a 90,000-pound six-axle truck is that fewer trips are required to carry the same amount of payload, resulting in almost 30 percent fewer ESAL miles per payload ton-mile.

The effect of ESALs on pavements is not constant throughout the year. During the winter, when the ground is frozen, a truck carrying a given load causes much less damage to pavements than at other times of the year. During the spring, the inverse is true: pavement layers are generally in a saturated, weakened state due to partial thaw conditions and trapped water, causing greater pavement damage by the same truck.

The pavement analysis also accounted for nontraffic-related pavement deterioration due to weather and other factors. These nonload-related factors are much more significant on local roads, which have lower heavy-truck volumes, and thus are subject to fewer ESALs per year.

## Bridge Considerations

Wisconsin has a known inventory of almost 14,000 bridges on state and local roadways that are maintained by the respective jurisdictional agency. By the Federal Highway Administration (FHWA) definition, a bridge has a minimum clear span length of 20 feet between the face of abutments. There are an unknown number of other structures with a clear span length less than 20 feet that are not included in the state inventory. A majority of these other structures is under local jurisdiction, and little information is known about the type, size, and structural capacity of these structures. This study does not address the cost to post, rehabilitate, or replace these smaller structures, but these costs could be significant.

Increases in truck weight limits can affect bridges and other smaller structures in several ways. Should the legally allowable limits change, and the limits exceed the design criteria for a bridge, the bridge must be posted (signed for restricted use) to prevent those heavy vehicles from using it. As a general rule, most bridges constructed after the late 1970s, when the American Association of State Highway

---

<sup>1</sup> One limitation of ESAL pavement analysis is that it may not fully capture the costs for pavements that have inadequate bases and subgrades, potentially resulting in understated cost estimates for impacts to lower volume local roads with inadequate pavement foundations.

and Transportation Officials (AASHTO) Load Factor Design (LFD) standards were implemented, can support the candidate TSW trucks. More recent standards, including the new (2007) AASHTO Load and Resistance Factor Design (LRFD) Bridge Design Specification should also allow passage of heavier vehicle loads. However, significant numbers of older bridges and other structures not designed for this new vehicle loading are impacted most and present a major challenge to carry the heavier vehicle loads.

Another impact of changing allowable limits is the increased agency costs for inspecting and rating bridges and structures and for posting signs. Concrete decks, supporting beams and girders, and other bridge elements can wear out with repetitive loadings by heavy vehicles. The number, spacing, and weight of individual axles, as well as the GVW carried on a truck, are important considerations for bridges. To protect bridges from overstress, Wisconsin law requires vehicles to meet the Federal Bridge Formula.

A major investment is necessary to maintain and upgrade the inventory of bridges and structures to allow for the current size and weight limit vehicle load, as well as any adjustments to the TSW loading. Without significant investment, heavy trucks will face longer routes as additional bridges are posted. Noncompliance to bridge postings (a safety risk and significant infrastructure cost) will continue to be a major enforcement issue.

### **Highway Safety Considerations**

Large trucks (vehicles 10,000 pounds gross vehicle weight or greater) have historically exhibited a higher fatal crash rate than other vehicles. In recent years, the gap in crash rates between large trucks and all other vehicle types has closed and, in fact, in the State of Wisconsin, large trucks have had a slightly lower fatal crash rate for the past seven years (See Figure ES.2).

**Figure ES.2 Wisconsin Fatal Crash Rates by Vehicle Type**  
1984 to 2007

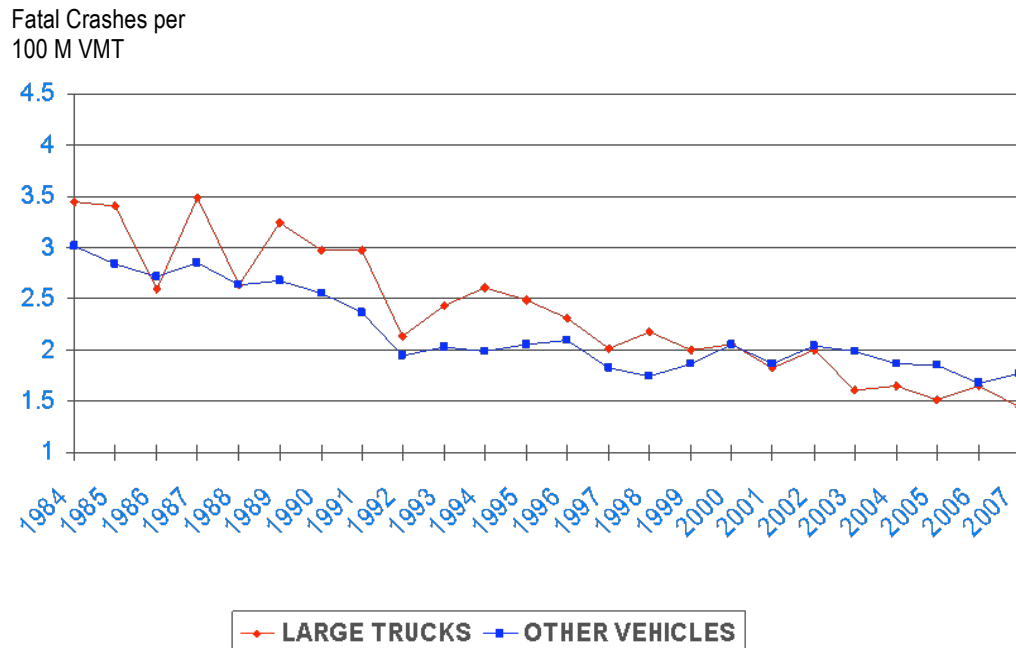

Source: Wisconsin Bureau of Transportation Safety.

Based on additional analysis of crash records from the WisDOT Bureau of Transportation Safety (BOTS), Figure ES.3 shows the relationship between large truck crash rates in Wisconsin (large truck crashes per 100 million large truck VMT), trucks hauling two trailers or “doubles” (doubles crashes per 100 million doubles VMT), and all other vehicles (all other vehicle crashes per 100 million other vehicle VMT). Crash rates for other vehicles are significantly higher than the crash rates for large trucks and doubles. There are many factors which may contribute to the lower values for large trucks and doubles. Commercial vehicles are more frequently operated on Interstates and other expressways as opposed to local roads which typically have higher crash rates. Also, commercial vehicles are often involved in long haul traveling with minimal lane shifts or turning movements. In addition, commercial drivers license holders have more training and experience than most drivers.

**Figure ES.3 Wisconsin Crash Rates by Vehicle Type**  
1984 to 2007

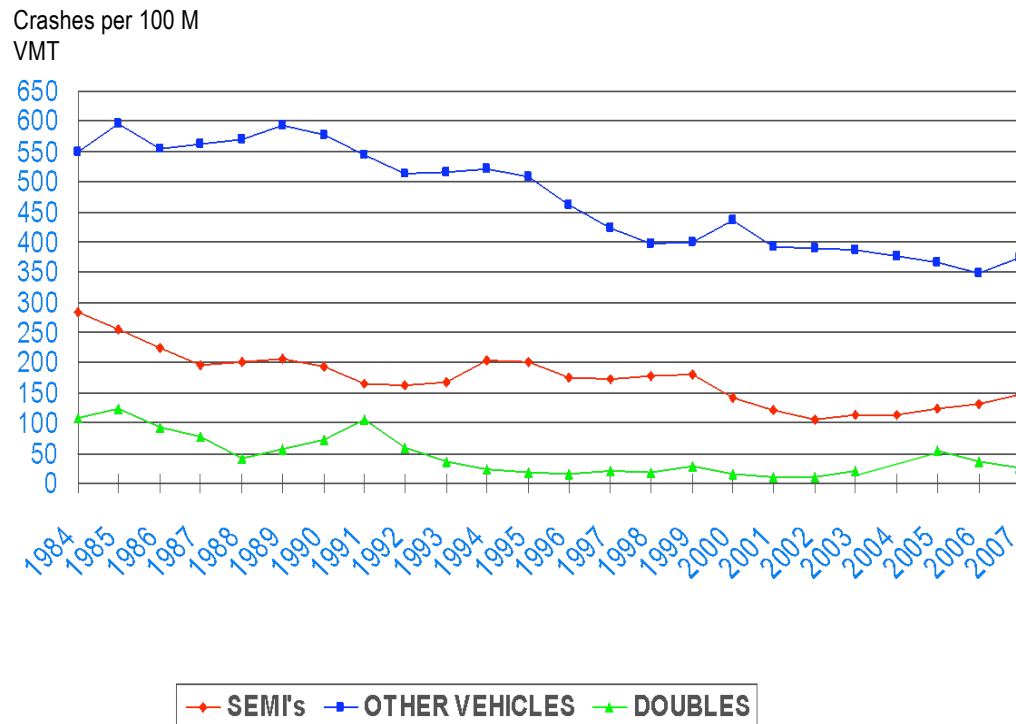

Source: Wisconsin Bureau of Transportation Safety.

Changes in TSW regulations can affect highway safety by: 1) increasing or decreasing the amount of truck traffic; 2) causing or requiring changes in vehicle design and vehicle performance that may affect crash rates and severity; and 3) causing trucks to shift to highways with higher or lower crash rates. Crash rates per vehicle-mile increase slightly with gross weight primarily because loading a truck heavier raises its center of gravity and thereby increases the possibility of rollover. However, crash rates per payload ton-mile decrease with a gross weight increase because fewer truck trips are required to haul a given amount of freight.

All heavier vehicles proposed in the project were evaluated against internationally accepted safety performance standards such as rollover threshold and offtracking. Of the configurations analyzed, the six-axle 98,000 pound straight truck-trailer (6a STT 98) failed to satisfy the load transfer ratio and static rollover threshold performance measures while the seven-axle 80,000 pound single unit truck (7a SU 80) failed the low-speed steer axle friction utility test. The 6a STT 98 configuration is most frequently operated by the timber industry and while the configuration demonstrates a higher rollover risk in laboratory conditions, industry representatives report no observed rollover issues in the field, possibly due to lower operating speeds, load configuration, and experienced drivers. All other configurations met basic international standards. In the area of low-speed offtracking (an important indicator of performance in roundabouts), all of the

vehicles examined were within the acceptable limits. Appendix C details the full results of this analysis. In addition, the review of international practice revealed for this study that technology enhancements – such as roll stability features – can further improve the safety performance of heavy trucks.

Finally, configuration evaluation results show that there is greater surplus brake capacity for all of the proposed vehicle configurations than for the standard five-axle tractor semitrailer because of the additional axles required. This means that under loaded conditions, the proposed vehicle configurations should have better stopping distance performance than the existing five-axle tractor semitrailers.

## PROJECT APPROACH

The study has benefited from the input from three oversight bodies established to guide this project and to assist Wisconsin with future freight transportation activities. The Trucking Issues Working Group, comprised largely of WisDOT, FHWA, and Federal Motor Carrier Safety Administration (FMCSA) representatives, provided technical guidance and direction. The Study Advisory Group includes representatives from stakeholder industries, the Wisconsin Legislature, academia, and local agencies and served as the policy review body, establishing key study directions and guiding principles (Table ES.1). The Study Advisory Group established the guiding principles early in the project to set the parameters for analysis of proposed alternatives. Finally, a Peer Review Panel was organized by the University of Wisconsin's National Center for Freight, Infrastructure, Research, and Education (C-FIRE) to convene national experts in TSW to provide technical and policy direction and perspectives.<sup>2</sup>

### Table ES.1 Guiding Principles

---

- Changes will consider the impact of Federal TSW laws;
  - Changes should seek to protect highway infrastructure at all levels of government;
  - Changes should not be a detriment to highway safety;
  - Changes should benefit the State's economy and competitiveness of industry;
  - Changes should promote the uniform application of TSW provisions within the State and, where possible, with neighboring states;
  - Changes should promote equity and fairness in application;
  - Users should pay the costs they impose on the system;
  - Changes should be easily understood, easily administered, and easily enforced; and
  - Changes should be consistent with State transportation performance measures and the infrastructure considerations of local jurisdictions.
- 

---

<sup>2</sup> For greater detail on the activities of these committees and the outreach effort, visit <http://www.topslab.wisc.edu/workgroups/wtsws.html>.

The study conducted three major activities: outreach, research, and analysis. An extensive outreach process was conducted including a series of private sector individual and group interviews; two Public Agency Outreach Workshops; one Safety Issues Workshop; and a culminating TSW Stakeholders Workshop. The objective of the outreach effort was to cast a broad net in order to capture both a cross-section of the State's trucking industry (to adequately address the varied interests of the firms who rely on the State's roadway freight infrastructure) and the inputs of public agencies and organizations directly involved in or affected by TSW laws, standards, and issues.

The research phase of the study considered the current size and weight laws of Wisconsin, compared laws and practices with surrounding states, reviewed trends in vehicle technology, and examined the safety performance of trucks operating in the State.

Collectively, the outreach and the research provided a range of potential changes to TSW laws, including configurations and policy changes. The configurations for evaluation evolved from several activities and sources. Because the outreach participants recommended harmonization of configurations, especially with surrounding states such as Minnesota, the evaluation included several of the recently-adopted Minnesota configurations, including the eight-axle single unit, the seven-axle 97,000 pound semitrailer, the six-axle 90,000 pound semitrailer, and the eight-axle 108,000 pound twin trailer. The six-axle 98,000 was singled out for analysis because it represents a recently exempted truck currently operating in Wisconsin and because it closely matches the six-axle 97,000 pound semitrailer endorsed by the American Trucking Associations and recommended by the Peer Review Panel. The six-axle 98,000 pound single unit with pup, which is another exempted and currently operating configuration, was suggested through industry outreach. All six configurations were vetted with the study advisory bodies and endorsed for analysis.

The analysis methodology for the project was based on nationally accepted methods utilized by the National Academy of Sciences and the U.S. DOT. The study team tailored the approach to Wisconsin, including the use of Wisconsin-specific data where possible.

## KEY FINDINGS

### Outreach

Key findings of the outreach process are shown in Table ES.2 and Table ES.3, divided into summaries of private sector and public agency sources.

**Table ES.2 Public Agency Outreach Key Findings**

Category	Issue Summary
General Approach	<ul style="list-style-type: none"> <li>• Changes to TSW Laws should:                             <ul style="list-style-type: none"> <li>– Be fair, equitable, and understandable</li> <li>– Examine what current and future infrastructure allows</li> <li>– Consider impacts on other freight modes</li> </ul> </li> </ul>
Economic Development	<ul style="list-style-type: none"> <li>• Keeping Wisconsin’s economy healthy and competitive is critical;</li> <li>• Emphasize link between State infrastructure spending and economic health of industry</li> <li>• Current TSW laws limit port traffic due to complexity</li> </ul>
Enforcement	<ul style="list-style-type: none"> <li>• Current enforcement tools (low level of enforcement and low fines) foster an “incentive for noncompliance”</li> <li>• Enforcement power should be increased</li> </ul>
Safety	<ul style="list-style-type: none"> <li>• Analyze effect of large trucks on highway safety</li> <li>• Evaluate safety risk for bridges</li> <li>• Consider requirements for truck safety countermeasures</li> </ul>
Infrastructure	<ul style="list-style-type: none"> <li>• Designate heavy truck corridors (to limit county/local road use)</li> <li>• Evaluate bridges, geometric design of intersections</li> </ul>
Federal-State	<ul style="list-style-type: none"> <li>• Federal leadership is needed for significant TSW changes</li> <li>• Consider impact of U.S. 41’s conversion to an Interstate highway</li> </ul>
Revenue	<ul style="list-style-type: none"> <li>• Ensure direct linkage between commercial vehicle revenues and covering the costs of heavy trucks’ impact on the transportation system</li> <li>• Transportation revenue and funds should be invested into transportation alone, with a focus on preservation/rehabilitation of existing infrastructure</li> </ul>

**Table ES.3 Private Sector Outreach Key Findings**

Issue Summary
<p><b>INTERSTATE HARMONIZATION</b> – Any TSW changes (including OS/OW permitting) should be harmonized across state boundaries</p>
<p><b>INTERSTATE HIGHWAY ACCESS</b> – More productive truck configurations should be allowed on the Interstate system, which can accommodate the heavier loads, consider impact of U.S. 41 conversion</p>
<p><b>REVENUE RETENTION</b> – Revenue from permitting should be reinvested in bridge and other freight truck-related improvements along key routes</p>
<p><b>EQUITABLE CHANGES AND EXCEPTIONS</b> – TSW changes should be equitable across industries and existing exceptions should be preserved</p>
<p><b>GREEN POLICY</b> – The State should promote TSW changes as “green” policy (reduced carbon, lower fuel consumption, and less congestion due to lower numbers of trucks)</p>
<p><b>IMPROVED INFORMATION</b> – Information about roads, bridges, and related information should be increased and available on the WisDOT web site</p>



## Research and Technical Analysis

The key finding of the research technical analysis was that several heavier truck configurations were reviewed and found to generate net statewide benefits. The evaluation considered transport savings, pavement costs, bridge costs, safety, and congestion. The analysis also include a separate evaluation of environmental and energy impacts.

Estimates are presented for the following configurations (with abbreviations shown):

- Six-axle 90,000 pound tractor-semitrailer (6a TST 90);
- Seven-axle 97,000 pound tractor-semitrailer (7a TST 97);
- Seven-axle 80,000 pound single unit truck (7a SU 80); and
- Eight-axle 108,000 pound double (8a D 108).

In addition to these four configurations, the analysis considered the following two six-axle 98,000 pound configurations which do not meet the Federal Bridge Formula but are both currently in use through exceptions in Wisconsin law:

- Six-axle 98,000 pound tractor-semitrailer (6a TST 98) (evaluated configuration does not meet the Federal Bridge Formula); and
- Six-axle 98,000 pound straight truck-trailer (6a STT 98) (evaluated configuration does not meet the Federal Bridge Formula).

The benefits and costs of each of the proposed changes are reported in Table ES.4. The benefits and costs shown in this table are based on the assumption that each candidate truck is implemented by itself. If all of the candidate trucks are implemented, the total benefits and costs for each category would be slightly greater than those shown for the six-axle 98,000 pound tractor-semitrailer.

The benefits shown in Table ES.4 assume existing Federal law prohibits operation on the Interstate system. Table ES.5 below illustrates the benefits that would accrue if national laws were changed to allow these configurations on Interstate highways in Wisconsin.

### *Key Assumptions of Results Tables*

The results tables below (ES.4 and ES.5) show results of the five criteria used to evaluate the potential introduction of the six candidate trucks on Wisconsin highways. The five evaluation criteria include transport cost, safety, congestion, pavements, and bridges for the new configurations compared to the base case scenario with an 80,000 gross vehicle weight limit. The results are expressed in millions of annual dollars per year. One-time costs for bridge replacements were annualized assuming a 10-year performance period and a 5 percent discount rate. The evaluation results for transport cost, safety, congestion, and pavement do not include any inflationary factor. The degree to which the State realizes these benefits depends upon the rate of conversion of the truck fleet to the new

configurations and the amount of investment in infrastructure, without which none of the benefits would be possible.

**Table ES.4 Annual Costs and Benefits for Candidate Configurations**  
*Operating on Non-Interstate Highways Only*

Fed Bridge Formula	Configuration	System User Benefits			Public Agency Benefits and Impacts			Net Benefits	
		Transport Savings	Safety	Congestion	Pavement	Bridge Costs for TSW Configs	Baseline Bridge Costs	With TSW Bridge Costs Only	With All Bridge Costs
Y	Base Case	0.00	0.00	0.00	0.00	0.00	(55.50)	0.00	(55.50)
Y	6a TST 90	5.50	0.46	0.92	2.57	(2.18)	(55.50)	7.26	(48.24)
Y	7a TST 97	6.27	0.70	0.85	3.87	(3.08)	(55.50)	8.62	(46.88)
Y	7a SU 80	2.46	0.11	0.08	0.40	(2.26)	(55.50)	0.78	(54.72)
Y	8a D 108	3.42	0.46	0.49	3.34	(6.02)	(55.50)	1.69	(53.81)
N	6a TST 98	19.19	1.52	1.89	1.10	(8.48)	(55.50)	15.23	(40.27)
N	6a STT 98	2.19	0.09	0.06	0.03	(4.22)	(55.50)	(1.85)	(57.35)

Note: All values in millions (assumes non-Interstate highway operation only).

**Table ES.5 Annual Costs and Benefits for Candidate Configurations**  
*Assuming Interstate Operation Is Allowable*

Fed Bridge Formula	Configuration	System User Benefits			Public Agency Benefits and Impacts			Net Benefits	
		Transport Savings	Safety	Congestion	Pavement	Bridge Costs for TSW Configs	Baseline Bridge Costs	With TSW Bridge Costs Only	With All Bridge Costs
Y	Base Case	0	0	0	0	0.00	(55.50)	0.00	(55.50)
Y	6a TST 90	36.64	3.48	3.44	14.65	(2.18)	(55.50)	56.03	0.53
Y	7a TST 97	41.83	4.43	4.08	19.91	(3.08)	(55.50)	67.18	11.68
Y	7a SU 80	9.83	0.53	0.09	1.53	(2.26)	(55.50)	9.73	(45.77)
Y	8a D 108	22.77	2.90	1.65	16.76	(6.02)	(55.50)	38.06	(17.44)
N	6a TST 98	127.94	9.40	11.03	10.19	(8.48)	(55.50)	150.09	94.59
N	6a STT 98	14.61	0.68	0.26	0.32	(4.22)	(55.50)	11.65	(43.85)

Note: All values in millions (assumes Interstate highway and non-Interstate highway operation).

The tables organize the criteria by beneficiaries – system users and public agencies – to demonstrate which group receives cost savings (benefits) or is impacted by increased costs (expressed as negative costs in parentheses). The system users are the private companies and individuals who use the Wisconsin highway system. The public agencies are those State and local government entities that bear the direct responsibility of maintaining the transportation system.

The five evaluation criteria include the following measures:

1. **Transport cost savings** accrue to private carriers resulting from the productivity increase of heavier or larger trucks, which allows them to carry more freight with fewer trucks. The savings of a smaller, more productive fleet include lower driver, repair, fuel, tire, and overhead costs and in this analysis also account for equipment conversion/upgrade costs. Presumably these cost savings also benefit shippers (lower shipper rates) and consumers (lower purchase costs as a share of lower transport costs are passed on).
2. **Safety cost savings** accrue to private freight carriers and the general driving public from the reduction in truck vehicle miles traveled (VMT) associated with TSW changes. The lower truck VMT reduces the potential for heavy trucks to be involved in accidents. While crash probability generally increases with weight of a truck, the lower number of trucks combined with increased braking power from additional axles results in fewer accidents involving heavy trucks statewide. The net safety benefits include lower costs associated with fatalities, injuries, and property damage.
3. **Congestion cost savings**, as mentioned above, accrue to private carriers, and drivers of personal vehicles. The congestion cost savings result from fewer trucks on the highways creating less delay and generating time savings, especially on urban highways.
4. **Pavement cost savings** accrue to the public agencies that avoid maintenance costs due to the lower ESAL impacts provided by distributing truck weight over additional axles. Some pavement savings are also related to lower truck VMT.
5. **Bridge costs** are shown in two columns to reflect the bridge costs associated with the TSW proposal and the base scenario needs of the State's bridge system<sup>3</sup>. The first column "Bridge Costs for TSW Configs" accounts for costs associated with bridge replacement, repair, or upgrade required for the proposed configurations. The second column "Baseline Bridge Costs" expresses the existing bridge needs in the State estimated at \$55.5 million per year. These baseline bridge costs would have to be funded to support baseline conditions or any heavier trucks.

While the bridge cost estimates reflect costs estimated for this study, Table ES.4 and Table ES.5 **do not account for the entire magnitude of the state and local bridge replacement costs for heavy truck operations**. The total cost to replace all statewide deficient bridges on both the state and local routes far exceeds the amount shown (see Section 7.0 for greater detail). The

---

<sup>3</sup> All estimated bridge replacement costs are based on current deck areas, assume bridge construction costs only, and only consider Wisconsin's most common bridge types. Actual costs may be higher due to larger deck areas for new bridges, roadway approach work associated with each bridge replacement, and additional bridge types in need of replacement that were not considered in the study.

total cost to replace all statewide structures less than 20 feet also exceeds the amount shown in the following tables and requires additional evaluation and study. These results only account for the bridge replacement cost associated with the candidate configuration vehicles' impacts on bridges. WisDOT has maintained that the Department cannot support changes that add to infrastructure costs without provisions that fund those added costs.

Note also that the results shown in Table ES.4 assume a 10 percent shift of freight carried by Scenario trucks from the Interstate system to non-Interstate highways. The Base Case Scenario assumes that five-axle, 80,000 pound tractor-semitrailers, and four-axle, 67,000 single unit trucks are carrying the freight which would potentially shift to the candidate configurations.

### *Results Summary*

The major finding of this analysis is that five of the six truck configurations reviewed generate net statewide benefits if they are allowed on non-Interstate highways and if the impacts on bridges are limited to the direct impacts of the new truck configurations (see Table ES.4 column "Net Benefits With TSW Bridge Costs Only"). The magnitude of benefits increases significantly if the new configurations are also allowed on the Interstate highway system (see Table ES.5 "Net Benefits With TSW Bridge Costs Only"). However, because the State faces baseline maintenance needs to support existing truck traffic on its structures, the backlog of total state bridge costs overwhelms the benefits for all trucks in this evaluation, unless the configurations are also allowed to operate on the Interstate system (see Table ES.5 column "Net Benefits With All Bridge Costs"). When all highways are considered – including Interstates – three of the new configurations would generate net benefits (6a TST 90; 7a TST 97; and 6a TST 98).

Taking into account the total bridge costs and the ability to operate on the Interstate, the most successful new configuration, in terms of net benefits, is the six-axle 98,000 semitrailer (6a TST 98), which generates the highest savings in transport costs, safety, and congestion. However, this truck, while currently operating under exception in Wisconsin, does not meet the Federal Bridge Formula with its commonly used axle spacings. The next most beneficial truck is the seven-axle 97,000 pound semitrailer (7a TST 97) followed by the marginally beneficial six-axle 90,000 pound semitrailer (6a TST 90).

Independent of the bridge considerations, all proposed configurations generate positive benefits across the four other evaluation criteria – transport costs, safety, congestion, and pavements. The most pavement-friendly configurations are those with the greatest distribution of weight across axles (lowest ESAL impacts), including the seven-axle 97,000 pound semitrailer and the eight-axle single unit. The six-axle 90,000 pound semitrailer also exhibits high pavement savings.

### *Other Results*

In addition to the analyses presented in Table ES.4 and ES.5, sensitivity analyses were conducted for several factors. This included potential rail diversion and different scenarios for diversion from current trucks to the new configurations.

The rail sensitivity tests show that as rail-to-truck diversion increases (as freight moves from rail to the new configurations) transport costs savings increase but pavement, safety, and congestion savings are reduced (because there are more trucks on the roads). While the rail diversion sensitivity tests show reduced savings across some of the evaluation criteria, the outreach participants and Peer Review Panel indicated that there is a low potential for any rail diversion. A more detailed explanation of rail diversion analysis is presented in Section 7.0 along with a brief description of the steps the State could take to develop improved rail diversion estimates.

Estimates are also presented for reductions in fuel consumption and emissions of carbon dioxide, particulate matter, and nitrogen oxides resulting from the introduction of Scenario trucks in Table ES.6.

**Table ES.6 Annual Fuel and Emissions Reductions for Candidate Configurations**

Configuration	Diverted Payload Ton-Miles	Fuel (gallons)	CO2 (pounds)	PM (grams)	NOX (grams)
6a TST 90	540	0.45	9.94	0.05	10.29
7a TST 97	450	0.54	11.97	0.06	12.40
7a SU 80	25	0.04	0.92	0.00	0.96
8a D 108	300	0.24	5.26	0.03	5.45
6a TST 98	900	1.42	31.62	0.16	32.76
6a STT 98	15	0.06	1.22	0.01	1.27

Note: All values in millions (assumes non-Interstate highway operation only).

Table ES.6 shows that the six-axle 98,000 pound semitrailer (6a TST 98) has the highest fuel and emissions reductions because it diverts the most payload ton-miles from the base case truck (five-axle 80,000 pound semitrailer). Other trucks with high energy and emissions benefits include the seven-axle 97,000 pound semitrailer (7a TST 97) and the six-axle 90,000 pound semitrailer (6a TST 90) combinations.

### Policy Issues Analysis

During the course of the study research and outreach, several potential policy-based changes to truck size and weight laws and regulations emerged for consideration by the State. These policy actions are not part of the analysis framework of the study, which focused on the configuration-based changes, and are provided for information and future evaluation.

- **Administer performance-based permit program.** Outreach participants, including those engaged through the Safety Workshop, suggested that any changes in TSW should be implemented and administered through a performance-based permit system. This system would allow new configurations – such as those listed above – but would require a continued

record of good standing or compliance from the carriers using the new configurations. The record of good standing might include such performance measures as:

- The consistent achievement of safety performance;
- Certification of additional driver training or experience in order to operate the new trucks; or
- Continued compliance with allowable weights – validated through periodic inspections and/or paper audits of logs.

Canada offers a rich source of peer experience with performance-based standards for productive truck configurations that may provide further insight on the development of standards and measures for a Wisconsin system.

- **Develop a comprehensive truck crash study.** This study utilized available WisDOT data to analyze truck crash trends statewide and by county, but additional research is needed to more definitively pinpoint the factors driving the trends. The study should also focus on crash rate differences between configurations, if possible.
- **Work with the Federal government to explore the potential for TSW changes on the Interstate System.** Given the recent discussion of truck size and weight changes for potential inclusion in the upcoming Federal surface transportation authorizing bill, the State examined the effects of TSW changes both on and off the Interstate system. The Interstate analysis, which does not represent an intention by the State to allow the new configurations on its Interstates, provides information on the potential benefits – which are significantly greater than TSW changes to the State and local systems exclusive of the Interstate. In the future, the State may want to work with Federal partners and AASHTO to define potential national TSW changes on the Interstate system, building on the analysis provided here. Stakeholders voiced nearly universal support for consideration of TSW changes to the Interstate, realizing the available cost savings and the ability of the Interstate system to generally accommodate heavier loads.
- **Review OS/OW permit process.** Applicants for oversize and overweight permits suggested that the State review permitting processes statewide (including local jurisdictions) to increase the speed of issuance of permits. While this study offers some insight into OS/OW permitting practices, additional study by the State is underway to determine what programmatic changes could be made to enhance permit activities, including possible adaptation for changing load demands (e.g., wind tower shipments). Because Wisconsin’s permit fees are below average for the region, the State may consider increasing fees to support permit program enhancement, increased enforcement resources, and other directly related activities. Several public agency stakeholders expressed the need for the price of permits to reflect the impact of the permitted load on infrastructure as well as the cost of the permit process.

- **Increase fines for commercial vehicle size/weight violations.** Research for this study on regional TSW enforcement found that Wisconsin's overweight/oversize fine structure is among the lowest among its Great Lake State peers. The State may want to adjust fines upward to discourage the "incentive for noncompliance" fostered by the currently low fines. (See Part A of this report for additional detail). Outreach participants - both public and private - strongly suggested that the State dedicate any new revenues from fines or permits to the infrastructure and programs (permitting, enforcement, etc.) directly related to highway freight transport.
- **Increase resources for TSW enforcement.** Compared to other states, Wisconsin's TSW enforcement resources - especially inspection personnel - are low compared to state routes miles. With any changes to TSW, additional resources may be required to ensure compliance and safety.
- **Review nonpermitted weight exceptions.** Currently several industries enjoy weight exceptions without permit requirements. These industries include dairy, forest products, septage, and livestock. Through the outreach activities of the study and through research into the way regional peer states treat exceptions, it is clear that Wisconsin has more industry-specific exceptions than other states. The suggestion of outreach participants is that the State pursue a more uniform policy that would potentially extend privileges across additional industries or standardize existing exceptions in a way that would not favor one industry over another.

## POLICY DIRECTIONS AND NEXT STEPS

This study has focused on three key questions: 1) Should changes be made to Wisconsin's TSW Laws? 2) What impacts would changes to TSW laws have on the state's roads and bridges, regulatory and enforcement capabilities, administrative processes, and freight transportation modes? 3) What specific requirements need to be met by any vehicles operating under modified size/weight standards. The policy directions that emerge from addressing these objectives must strike a balance between the economic benefits achieved through freight productivity improvement and the need to protect public safety and preserve state and local roads and bridges.

In view of current national/international economic conditions, declining state revenue, and costs associated with allowing heavier vehicles on state and local roads, the DOT makes no recommendations for changes to Wisconsin's TSW laws at this time. However, this report provides an excellent basis for a continuing dialogue with the legislature, local governments, the Federal government, other Midwestern states Wisconsin citizens, and the private sector regarding potential improvements to TSW policy and regulation. Towards that end, and taking into consideration the policy analysis issues, the following strategies may be pursued in the immediate future as funds allow:

- **Conduct a comprehensive study of truck crash trends on Wisconsin's state and local highway network.** Nationally, as well as in the State of Wisconsin, the number and rate of large truck crashes and fatalities is trending downward while large truck vehicle mileage continues to increase. However, while there have been decreases overall, there remain significant differences in large truck crash rates when examined at the county level. Further study needs to focus on the reasons for the differences and should also focus on the differences in crash rates – using available data – between configuration types (semitrailers, doubles, etc.).
- **Increase the visibility and coordination of freight efforts within WisDOT to more effectively address emerging freight-related issues.** Any organizational adjustment must consider emerging freight policy, planning, operations, and investment requirements. The AASHTO's recent recommendation that Congress authorize a state administered freight transportation program funded at \$18 billion for six years apportioned annually to the states to support highway freight transportation infrastructure improvements is an example of a national policy development that could significantly impact the states' organizational structure.
- **Review oversize/overweight permitting process.** A review of the Department's organization structure by which freight and truck issues are managed, may also include an assessment of the Department's oversize/overweight permit process including the feasibility of establishing a performance-based permit program for heavier vehicles. In addition, the review should examine the methods by which Wisconsin sets truck registration fees and truck overweight/oversize fines and how the State can



foster better permit coordination and potentially standardization with local jurisdictions. As mentioned earlier, additional study by the State is underway to determine what programmatic changes could be made to enhance permit activities, including possible adaptation for changing load demands (e.g., wind tower shipments).

- **Participate in the AASHTO discussion with the Federal government concerning weight limits on the national interstate highway network.** The AASHTO’s recently adopted Authorization Policy recommends that “states, in collaboration with the freight transportation industry and the Federal government, should investigate the feasibility of regional adjustments in truck size and weight in particular corridors that demonstrate important economic benefits and meet safety, pavement/bridge impact, and financing criteria.”
- **Conduct a comprehensive review of the state’s capacity to enforce TSW laws.** The safety of the traveling public and the preservation of the State’s highway infrastructure are the DOT’s highest priorities. Enforcing the states’ TSW laws is key to achieving these priorities. According to the 2009 State Enforcement Plan, Wisconsin’s size and weight enforcement resources are heavily focused on U.S. and Interstate highways, leaving minimal resources for enforcement on secondary and rural roadways. This review would assess the Patrol’s capacity to meet its responsibility for TSW enforcement and local officer training. In addition, the study will explore ways to reduce violations through expanded educational programs such as the one recently initiated by the Center for Transportation Studies at the University of Minnesota. This training promotes voluntary compliance to significantly reduce the damage to public roads caused by overweight vehicles.

## POLICY IMPLEMENTATION GUIDANCE

The findings of the Wisconsin TSW Study highlight challenges facing three areas of WisDOT management of commercial vehicles:

1. Oversize/Overweight Permitting Procedures;
2. Safety and Weight Enforcement Facility Inspection Technologies; and
3. Commercial Vehicle Information Systems and Networks (CVISN)

To address these challenges, the TSW Study offers additional guidance to improve the processes, procedures, and technologies through a review of national best practices appropriate to WisDOT delivery of TSW programs, potential future directions in program adoption for WisDOT, and lessons learned and barriers to implementation for the identified directions. The study offers the following recommendations in the three areas.

### *OS/OW Permitting*

WisDOT is developing innovative approaches to OS/OW permitting which would enable the Department to keep up with growing demand for larger and heavier vehicles while protecting Wisconsin’s infrastructure and the safety of all

roadway users. The first step in the process is coordination with Minnesota DOT as part of a broader bi-state cooperation agreement. Staff from both agencies will receive cross-training in the systems and processes of the other. This approach will culminate in true bi-state permitting, where staff from one agency could access the systems of both agencies simultaneously for any kind of permit. The states would potentially extend this concept over time to include additional states in the Upper Midwest in a broader multi-state permitting agreement, saving regional businesses time and money.

Additional opportunities for WisDOT to explore may include corridor-based permitting and performance-based permitting (discussed in Sections 9.0 and 10.0).

### *Safety and Weight Enforcement Facility Technologies*

Wisconsin has a large and growing network of fixed and virtual safety and weight enforcement facilities (SWEF) and is on the cutting edge for roadside inspection and enforcement. Like much of the United States, Wisconsin enforcement agencies are struggling to keep up with growing volumes of commercial trucks. In order to keep the roadways safe without burdening those trucks which operate responsibly within the laws, WisDOT has turned to some of the latest technologies in Virtual Weight Stations (VWS).

A typical VWS consists of a computer attached to a camera and a scale that weighs vehicles and identifies potentially overweight trucks. The VWS photographs and weighs potential weight limit violators passing the station and relays information to an enforcement officer down the road. When the VWS detects a potential violator, a patrol car can use the location and description to stop the truck. The first two VWS were installed in 2007 near Madison. Three additional VWS sites are under development with more planned for the future.

WisDOT is also exploring the use of License Plate Readers and other Automated Vehicle Identification (AVI) technologies. AVI technologies have the benefits of: enabling enforcement agencies to target resources towards offenders; increasing data collection abilities; and enabling inspectors to access safety, credentials, and criminal justice information in a timely manner.

### *Commercial Vehicle Information Systems and Networks (CVISN)*

The goal of the CVISN program is to improve commercial vehicle safety and operational efficiency nationally. The CVISN program relies on technologies to facilitate necessary commercial vehicle functions such as exchanging safety information, administering credentials electronically, and using information to focus enforcement resources on motor carriers with a history of safety problems. Wisconsin has complied with Federal standards for several years as an early leader in the program due to the cohesion and focus of the State's CVISN team.

The challenge that Wisconsin now faces is how to move CVISN out of the prototype stage and onto the same level as more mature registration and credentialing programs. Bringing CVISN into the mainstream will help

Wisconsin increase safety and security on Wisconsin roads. CVISN already assists enforcement identify and target roadside violators. In addition, improvements over the next two years should help state personnel process commercial vehicle applications and permits more efficiently.

## PERFORMANCE MEASUREMENT

In addition to the detailed review of potential changes to TSW laws, the TSW Study looks at the central objectives of moving freight, suggesting a range of measures and a process for settling upon a group of measures that might aid in defining and developing long-range benefits for both WisDOT and the trucking industry. These measures should provide a basis for ongoing discussion between the Department and the trucking industry and should provide an understanding of how the state highway infrastructure is meeting the needs of the freight-moving industries.

Following a series of interviews and a review of methods of communicating with private sector freight stakeholders and the performance based standards employed in other countries, the study team made the following recommendations:

- The Department should initiate a process with stakeholders in local government and industry to develop measures that reflect the significant aspects of freight transportation in Wisconsin.
- The Department should expand its efforts to listen to the shipping and carrying industries. Establishing a freight advisory committee is one good way to begin that process.
- The Department's internal structure also requires better coordination, communication, and alignment. Establishing an internal coordinating committee is a first step in this improvement. A second might be to identify a list of actions that should be taken – policies and procedures reviewed partnerships undertaken, etc. – that will make considerations of freight issues a normal part of agency operations.
- The Department should also take steps to help its freight customers better understand the agency. A position with a freight title is one possible measure. A freight web page with directions to other agency resources might also be of help.
- The Department should monitor the activities of other nations, most notably Canada, as they move further in the direction of performance-based standards for truck size and weight rather than purely prescriptive standards.
- The Department should consider developing an administrative procedure to evaluate reasonable requests for exceptions to truck weight rules.

WisDOT has already begun to take significant steps forward in these directions, taking such actions as: establishing a standing committee, with membership

from four divisions, to coordinate oversize/overweight permits; working with Minnesota to establish a more coordinated regional approach to issuing oversize/overweight permits; establishing an internal management committee, involving four WisDOT divisions, to provide coordination and direction to the total freight effort of the Department; and considering the establishment of an external freight advisory committee.

# 1.0 Scope, Limits, and Administration of Existing Truck Size and Weight Laws in Wisconsin

## 1.1 SUMMARY

The objective of this section is to summarize current laws governing commercial vehicle size and weight in Wisconsin, including state, Federal, county, and local statutes. The intent is to provide a clear description of current laws, including permitted exceptions to dimension and weight limits, that will assist WisDOT in determining whether to make recommendations to change existing laws. Federal, state, and some county/local laws are examined, including the following characteristics:

- Limits and provisions;
- Roles and responsibilities;
- Federal requirements;
- State enforcement practices;
- State and local permit processes; and
- Exceptions.

This summary of Wisconsin TSW laws draws from the Wisconsin Statutes, interpretive guidance from Wisconsin Department of Transportation (WisDOT) personnel (including representatives for the Bureau of Structures, Division of Motor Vehicles, WisDOT regional engineers, and State Patrol), Federal documents (including the Federal Register) American Association of State Highway and Transportation Officials (AASHTO) materials, and other interpretive materials. Throughout this memo, citations to the Wisconsin Statutes are provided in parentheses.

Two sections follow the main body of this section. Appendix 1A defines key size and weight terms, and Appendix 1B lists the National Network Highways of Wisconsin.

## 1.2 METHODOLOGY

This review organizes the information from these sources into several categories:

- Limits and provisions;
- Roles and responsibilities;
- Federal requirements;
- State enforcement practices;
- State and local permit processes; and
- Exceptions.

This review draws principally from the Wisconsin Statutes and associated interpretive materials provided by WisDOT. Federal regulations were also consulted. The primary sources consulted for this memorandum include:

- *Wisconsin Statutes 2008*;
- *Wisconsin Trucker's Guide 2007*;
- *Code of Federal Regulations 23, Part 658*;
- *Federal Size Regulations for Commercial Motor Vehicles*;
- *AASHTO Guide for Vehicle Weights and Dimensions*;
- WisDOT Division of State Patrol *State Enforcement Plan, 2009*;
- WisDOT and FHWA Internet sites; and
- Interviews with WisDOT staff.

## 1.3 FINDINGS

### Limits and Provisions

This section describes the vehicle width, height, length, and weight provisions which are applicable to most commercial vehicles traveling in Wisconsin. Generally, these limits and provisions are universally applicable and do not require special permits. Principal exceptions, most of which require permits, are described in a subsequent section. For each of the laws summarized in this section, the Federal limit, where applicable, also is noted.

Seasonal weight limitations are discussed in the subsequent exceptions section.

The truck width, height, and length limits are shown in simplified format in Figure 1.1. For greater detail, see the remainder of the limits and provisions section as well as the exceptions section.

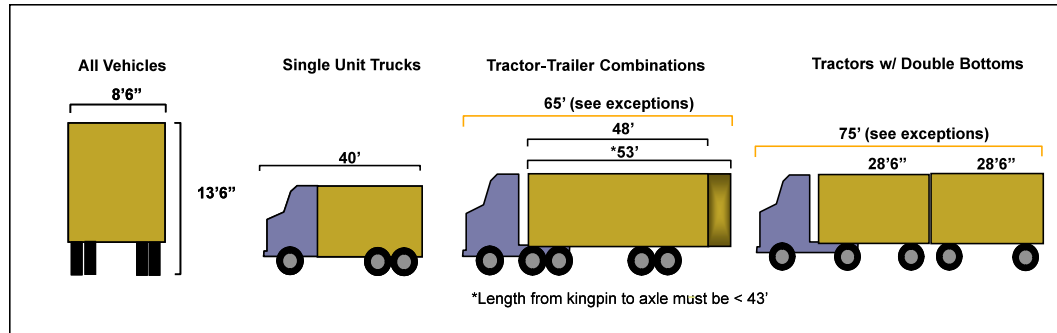
**Figure 1.1 Truck Size Limits**

### Width

**Definition.** The total outside transverse dimension of a vehicle, including any load or load-holding devices thereon, but excluding noncargo-carrying equipment.<sup>4</sup> (AASHTO)

- The maximum allowable width in Wisconsin is 102 inches (8 feet, 6 inches), which is also the Federal limit (348.05(1)).

### Height

**Definition.** The total vertical dimension of a vehicle above the ground surface, including any load and load holding device thereon.<sup>5</sup> (AASHTO)

- Wisconsin's maximum allowable height is 162 inches (13 feet, 6 inches). There is no Federal height limit; each state sets its own height standards (348.06(1)).

### Length

**Definition.** The total longitudinal dimension of a single vehicle, a trailer, or a semitrailer, including bumper and load, but excluding noncargo-carrying equipment.<sup>6</sup> (AASHTO)

- Wisconsin's maximum vehicle length is 40 feet for any single vehicles and 65 feet for any combination of two vehicles (348.07(1)). However, there are several common exceptions to this rule, reviewed in the "Length Exceptions" section of this memorandum.

In Wisconsin, the length of a semitrailer or trailer is measured from the front of the trailer to the rear of the semitrailer, trailer, or cargo, whichever is

<sup>4</sup> <http://freight.transportation.org/doc/freight/GuideWeight.pdf>.

<sup>5</sup> Ibid.

<sup>6</sup> Ibid.

longer. Length excludes bumpers, stake pockets, air deflectors, and refrigeration units. (348.07(3)(b)1)

- On certain roadways, Wisconsin allows a double bottom configuration consisting of a truck tractor and two semitrailers. The maximum length of each individual semitrailer is 28.5 feet. The length of a semitrailer operated as the first trailing unit in a double bottom consisting of a truck tractor and two semitrailers does not include a frame extension bearing a fifth wheel connection by which the second trailing unit is drawn. If the frame extension is more than 8 feet long, it is to be included in the length of the vehicle. This, however, does not affect the measurement of length from the front of the semitrailer to the rear of the cargo. (348.07(3)(b)2)

### *Weight*

There are three central means of measuring commercial vehicle weight in Wisconsin: 1) gross vehicle weight (GVW); 2) axle weight; and 3) weight of tire(s) on each side of axles. Regulations exist to govern all three weight components so as to protect highway pavements and the integrity of short span bridges.

GVW, axle weight, and tire weight vary by highway class: Class A and Class B highways. In addition, all vehicles are subject to bridge weight restrictions.

#### **Class A Highways**

Class A highways (as defined in §348.15(1)) include all state trunk highways and connecting highways and those county trunk highways, town highways, and city and village streets, or portions thereof, that have not been designated as Class B highways pursuant to §349.15. The weight limits on Class A highways are:

- 80,000 pounds GVW, for any vehicle combination with five or more axles with minimum spacing (348.15(3)(c));
- 20,000 pounds GW for any single-axle; steering axle may not exceed 13,000 unless the manufacturer's rated capacity of the axle and tires is sufficient to carry the weight (348.15(3)(b));
- 34,000 pounds GW for consecutive sets of tandem axles, if the overall distance between the first and last axles of such consecutive sets of tandem axles is 36 feet or more (348.15(3)(d)); and
- 11,000 pounds GW for wheel(s) supporting one end of an axle (348.15(3)(a)).

#### **Class B Highways**

Class B highways include those county trunk highways, town highways and city and village streets, or portions thereof, which have been designated as Class B highways by the local authorities pursuant to §349.15. The weight limits on Class B highways are 60 percent of those imposed on Class A highways (348.16(2)). Thus, the weight limits on Class B highway are:



- 48,000 pounds GVW;
- 12,000 pounds GW for any single axle;
- 20,400 pounds GW for tandem axles; and
- 6,600 pounds GW for a wheel or wheels supporting one end of an axle.

### **Bridges**

To protect vulnerable bridges, state and local agencies can define and post additional weight limits which vary by bridge. The posting of bridges under the jurisdiction of the State (along state, U.S., and Interstate highways) is coordinated by the WisDOT Bureau of Structures. Authority for posting bridges lies with the management agency, typically local and regional transportation agencies.

Guidance for the rating and analysis process that goes into determination of allowable weights on bridges is contained in the *Wisconsin Bridge Manual*.<sup>7</sup> Factors such as the volume and character of traffic, the likelihood of overweight vehicles, and the enforceability of weight posting all are considerations into whether a bridge should be posted to prevent damage or failure. While efforts are made to promote uniformity in the standards for bridge-posting, there is no guarantee that local, county, and regional agencies all operate under the same standards. With few exceptions, bridge postings take precedence over any overweight permits.

The Bureau of Structures maintains data on the locations and allowable weights of all bridges, and allows shippers/carriers to view to a restricted-access bridge map which is updated annually.

The impact of heavy truck loads on bridges is an important consideration for the determination of roadway and axle maximum weight standards. The Federal Bridge Formula is designed to protect bridges by designating a maximum weight for all groups of two or more consecutive axles on a vehicle. Bridge preservation is an important factor in the inclusion of axle spacing requirements as a component of GVW requirements.

### **Roles and Responsibilities**

#### *Federal Highway Administration (FHWA)*

The FHWA is responsible for administering the Federal regulations governing commercial vehicle (truck and bus) sizes and weights. The Vehicle Size and Weight Program, one of the central responsibilities of the FHWA's Office of Freight Management and Operations, is guided by several key statutes and regulations. The statutes and regulations provide the program with its authority and govern its structure and performance. The statutory authority for the

---

<sup>7</sup> [http://on.dot.wi.gov/dtid\\_bos/extranet/structures/bridge-manual/index.htm](http://on.dot.wi.gov/dtid_bos/extranet/structures/bridge-manual/index.htm).

Federal oversight of vehicle size and weight activities is described in three locations within U.S. Code:

- Title 23 U.S.C. 127 establishes weight limits states shall allow and must enforce on the Interstate system;
- Title 23 U.S.C. 141 requires states annually to certify that they adequately are enforcing all State laws regarding size and weight limits as a prerequisite for receipt of Federal-Aid Highway funding; and
- Title 49 U.S.C. 31111-31115 establishes minimum size requirements on the National Network (NN) and access routes to the NN.

Additional provisions are codified in various locations in Titles 23 and 49. However, the entire set of regulatory provisions that guide the administration of the Vehicle Size and Weight Activity are found in the *Code of Federal Regulations, Volume 23, Parts 657 and 658*. These two sections outline the responsibilities of the Federal program, including the procedures for state certification and enforcement of Federal size and weight limits. Specifically, Part 657 describes the state certification process of submitting enforcement plans, annual plan updates, and certification evaluations to the FHWA and the role of the FHWA in reviewing and certifying these documents. Part 658 identifies the Interstate System and the NN of highways and the Federal motor vehicle size and weight limits that must be enforced on those NN highways to guarantee state eligibility for Federal highway funding.

### *State*

The WisDOT is the primary state agency involved in commercial vehicle regulation and enforcement. WisDOT shares regulatory and administrative functions among the Division of Motor Vehicles (DMV), State Patrol, and the Bureau of Highway Operations (BHO). The DMV is the primary issuer of oversize/overweight permits and handles the licensing and credentialing of truckers and trucking firms operating in Wisconsin. The State Patrol is responsible for TSW enforcement and safety regulation. The BHO is responsible for a variety of commercial vehicle and roadway management functions. Some examples include the maintenance of electronic credentialing for commercial vehicle and the determination of Class II roadways for weight limitation posting during the Spring Thaw. Wisconsin is somewhat unique in that all three of these groups and their associated tasks fall under the umbrella of WisDOT.

### *Local (County, Town, Municipal)*

Counties and other political subdivisions are authorized to set and enforce size and weight laws on their road and highway networks. Some laws may vary by jurisdiction. One of the primary roles of local government is the identification and posting of weight limits on roadways and bridges. This is frequently a source of conflict between commercial vehicle operators and local governments.

Counties and other political subdivisions may issue permits for other configurations that exceed Wisconsin Statutes for height, length, and weight as long as the movement occurs within the boundaries of that subdivision.

Additionally, these local agencies have the authority to deny OS/OW operation on State, U.S., and Interstate highways within their jurisdiction. For greater detail, see the Permit Process Section.

## Federal Requirements

### *Federal Regulations*

The **National Network** (NN) is defined in CFR 23, Part 658 as “the Interstate System plus other qualifying Federal-Aid Primary System Highways” as of June 1, 1991 as described in Title 23 of U.S.C. The National Truck Network consists of designated roadways throughout the United States that allow long combination vehicles, semitrailer trucks with two trailers and single-trailer trucks with an extra-long trailer. See Appendix B for a listing of the NN roadways in Wisconsin.

The NN also includes those routes that provide “reasonable access” to the NN from truck and bus terminals, for example. The regulation requires that states designate reasonable access and make that information available to motor carriers. It also stipulates that states administer an “access review process” to ensure proper analysis and review of access proposals. The regulation demands the submission of access provisions from each state allowing STAA-dimensioned vehicles on all public roadways by June 1990.

The current Federal limits on length, width, and weight are based on the STAA-dimensions and are presented in the context of applicability to the NN and its constituent parts (Interstates and Federal-Aid Primary Systems). In their most basic form, those limits on state regulations are set forth as:

- **Length** - 48 feet minimum trailers in tractor-trailer combinations and 28 feet minimum on any trailer in either a tractor-semitrailer-trailer combination, applicable to the National Network routes;
- **Width** - 102 inches minimum and maximum width, applicable to the National Network routes;
- **Height** - There is no Federal height limit; these limits are set by the states; and
- **Weight** - 80,000 pounds maximum gross vehicle weight (GVW) limit, applicable to the Interstate System component of the NN (not the entire NN), except where the bridge formula dictates a lower vehicle weight:
  - 20,000 pounds per single axle; and
  - 34,000 pound per tandem axle.

The bridge gross weight formula is set forth below. It is used to specify the maximum gross weight allowed on any group of two or more consecutive axles based on the relationship between the number of axles and distance between axles. Figure 1.2 shows the FHWA’s calculation tool, highlighting the complex nature of this important input into allowable weight determination for bridges.

**Figure 1.2 FHWA Bridge Formula Weights Calculator**

**Bridge Formula Weights Calculator**

Sample Configuration:

Bridge Formula:

$$W = 500 \left[ \frac{LN}{N-1} + 12N + 36 \right]$$

Distance Between Axles (L)  
 ft.  in.

Number of Axles (N)

Maximum Weight in Lbs. (W)\*

**Calculate**

*\*Calculated values reflect FHWA's policy of rounding down when weights fall exactly between 500-pound increments. Because the Bridge Formula is designed to protect infrastructure, FHWA determined that this conservative policy is consistent with the statutory mandate.*

Source: FHWA, [http://ops.fhwa.dot.gov/freight/sw/brdgcac/calc\\_page.htm](http://ops.fhwa.dot.gov/freight/sw/brdgcac/calc_page.htm).

### LCV Freeze

The regulation also affirms the ISTEA freeze on enforcement of longer combination vehicles (LCV) on the Interstate and Defense Highways. The LCVs include any tractor and double or triple trailer, or double semitrailer combinations, excluding the STAA authorized twin 28 feet allowed on the NN, with a gross vehicle weight in excess of 80,000 pounds. Wisconsin does not have any LCV regulations grandfathered under ISTEA.

### Federal Regulations on Enforcement

Federal regulations specify enforcement as a state activity and place the burden of compliance with Federal regulations for size and weight on the states. The objective of the regulation is for states to develop programs to identify oversize and overweight vehicles and to systematically reduce violations thereby improving conditions for safety and system preservation. The statute requires states to engage in enforcement activities as a means of discouraging the violation of size and weight regulations.

Ultimately, there are two justifications underlying the Federal requirement for states to engage in enforcement activities that reduce violations. Those justifications are:

- **System Preservation** - Adherence to vehicle size and weight limits by motor carriers preserves pavement conditions and bridge structures; and
- **Safety** - Compliance with vehicle size and weight limits creates a safer driving environment.

To this end, states are required annually to submit two documents to the FHWA demonstrating enforcement of Federal size and weight regulations:

- **State Enforcement Plan (SEP)** or annual Enforcement Plan Update, articulates the approach, resources (facilities, technology, and personnel) and procedures (hours, locations) used by the state to enforce size and weight laws.
- **Enforcement Certification.** The state's governor or designated agent (usually the Department of Transportation Secretary or Commissioner) submits a statement affirming that all state laws and Federal limits, including the ISTEA freeze on LCVs and other multiunit vehicles, are enforced on the Interstate System and all Federal-Aid Primary and Secondary Highways in the state and that all state laws governing size and weight regulation on the Interstate System are consistent with 23 U.S.C. 127 (a) and (b). The Enforcement Certification must document changes to state laws or regulations made since the last certification. Finally, the Certification must include a report of state size and weight enforcement activities during the past year with several data requirements: 1) actual number of enforcements versus those forecast in the Enforcement Plan, with focus on changes in operation from those proposed in the Enforcement Plan; 2) the outcomes of the enforcement process actually applied in terms of changes in the number of oversize and overweight vehicles identified; 3) total vehicles weighed and type of device used; 4) number and type of penalties; and 5) the number and type (divisible versus nondivisible) of permits issued for overweight loads.

### **Certification Failure**

If a state fails to certify that it is adequately enforcing all state size and weight laws on Federal-Aid Highways, the State's annual apportionment of Federal-Aid Highway funds may be reduced by 10 percent of the amount that would otherwise be apportioned. A 10 percent reduction may result in the following instances: 1) the State fails to submit a certification, or 2) the Federal Highway Administrator determines that the State is not adequately enforcing size and weight regulations, despite the submission of a certification report. In both cases, the Federal Highway Administrator will transmit a determination of nonconformity identifying the reasons for the decision.

### **State Enforcement Practices**

Enforcement of TSW laws is the responsibility of the Wisconsin State Patrol. The Patrol's Size-Weight Enforcement Program monitors commercial carriers to

ensure that they are operating within statutory or permitted size and weight limitations. The State Patrol also runs the Motor Carrier Safety Assistance Program, intended to reduce the number and severity of crashes and hazardous material spills involving large trucks.

The Size-Weight Enforcement Program has several key components. Fixed location safety and weight enforcement facilities (SWEF) operate on the most heavily trafficked freight corridors in Wisconsin. Weigh-in-Motion (WIM) technologies are in place in several locations. Figure 1.3 and accompanying Table 1.2 show the locations of Wisconsin's 16 SWEFs and the routes they serve. Equipment utilized by the State Patrol includes 13 fixed platform scales (9 on the Interstate, 4 non-Interstate, National Highway System locations), 108 portable wheel weigher scales, and 12 weigh-in-motion (WIM) locations (located at Safety and Weight Enforcement Facilities).<sup>8</sup>

Enforcement of size and weight regulations on secondary and rural roadways is largely accomplished through deployment of State Patrol inspectors, equipped with portable scales to weigh and cite trucks when in violation.

According to information included in the 2009 *State Enforcement Plan*, Wisconsin's size and weight enforcement resources are heavily focused on U.S. and Interstate highways, leaving minimal resources for enforcement on secondary and rural roadways. There are 64 Wisconsin State Patrol full-time equivalent positions allocated toward truck size and weight activities which translates to approximately 100 to 110 Wisconsin State Patrol inspectors using a portion of their time to conduct size/weight activities.<sup>9</sup> While the total number of state troopers is currently statutorily limited to 380, the number who perform motor carrier enforcement activities is not statutorily limited. Further, the state patrol offers size/weight training to officers from law enforcement agencies throughout the state for size/weight activities within their respective communities, independent of State Patrol enforcement activities. Note: The State Patrol offers used but functional scales to local "trained county, municipal, and tribal law enforcement agencies," when updating its equipment.

---

<sup>8</sup> FHWA Operations Vehicle Size and Weight Enforcement – *Wisconsin State Enforcement Plan* 2009.

<sup>9</sup> Ibid.

**Figure 1.3 Locations of Safety and Weight Enforcement Facilities**

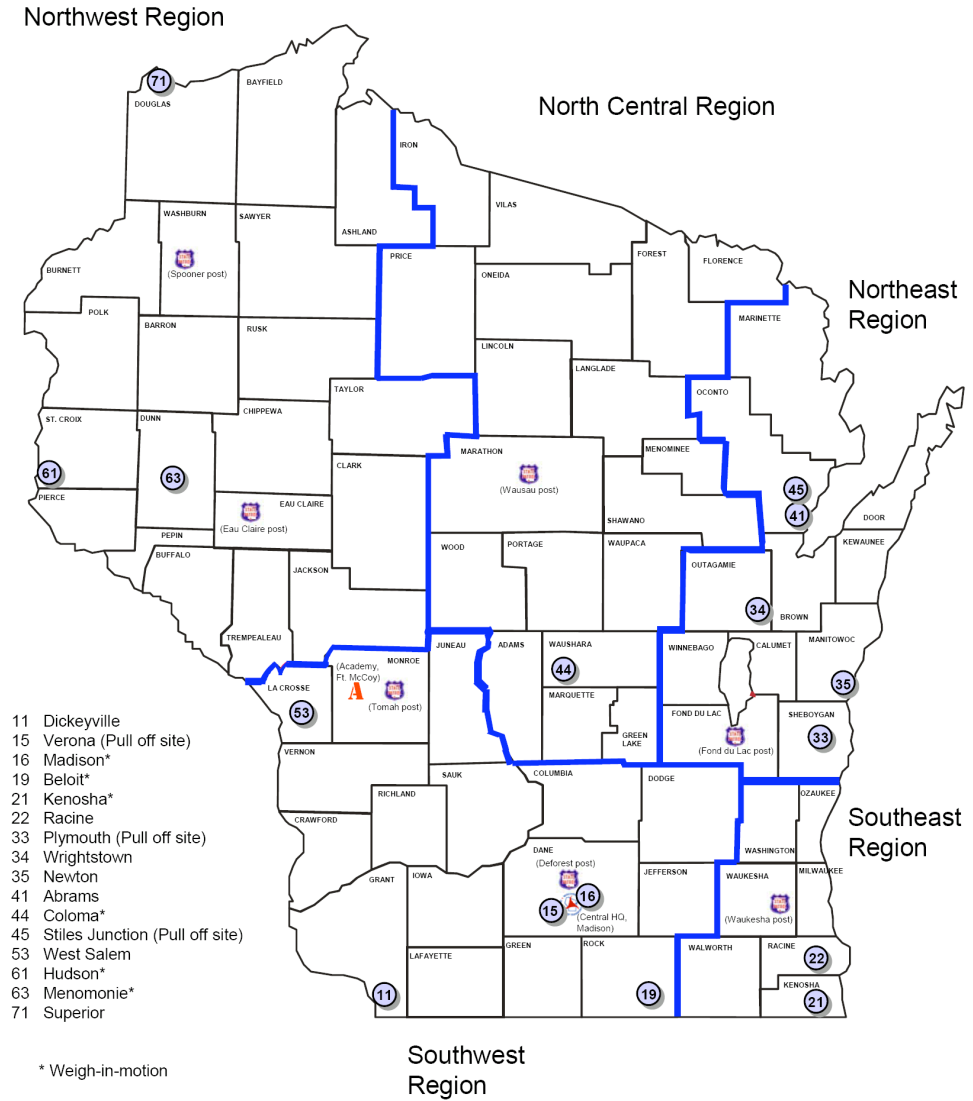

**Table 1.1 Locations of Safety and Weight Enforcement Facilities**

Location (see map)	Route
Dickeyville SWEF (11)	Hwy 11, 35 and 151
Verona pull off site (15)	Hwy 18, 2 miles east of Verona
Madison SWEF (16)*	Hwy I-90 MP 145.5, 1 mile W. CT N
Beloit SWEF (19)*	Hwy I-39/90 MP 180
Kenosha SWEF (21)*	Hwy I-94 MP 349.8, 0.25 mile N. of Illinois Line
Racine SWEF (22)	Hwy I-94 MP 327.3, 0.25 mile S. of CT G
Plymouth pull off site (33)	Hwy 57, 1 mile east of Plymouth,
Wrightstown SWEF (34)	Hwy 41, Brown and Outagamie County Line
Newton SWEF (35)	Hwy I-43 MP 141, 0.5 mile S. of CT F
Abrams SWEF (41)	Hwy 41 and 141, 3 miles S. Jct. 41 and 141
Coloma SWEF (44)*	Hwy I-39/51, 1.5 miles N. of Coloma
Stiles Junction pull off site (45)	Hwy 141, 1/4 mile south of Hwy 22
West Salem SWEF (53)	Hwy I-90 MP 10.6, 2 miles W. of CT B
Hudson SWEF (61) <sup>a</sup>	Hwy I-94 MP 8, 3.5 miles E. of Hwy. 12
Menomonie SWEF (63)*	Hwy I-94 MP 48.3, 1.5 miles E. of CT E
Superior SWEF (71)	Hwy 2 and 53, 6 miles E. of Superior

<sup>a</sup> Weigh-in-Motion.

Source: Wisconsin State Patrol (last revised April 2008).

## State and Local Permit Processes

Before transporting an oversize or overweight load, the hauler is required by law to apply for an oversize/overweight (OS/OW) permit. The legal guidelines for permitting authority can be found in Wisconsin Law (348.25-27) and exceptions to standard OS/OW permit processes are described in the Exceptions section of this memorandum. Most OS/OW permits for State, U.S., Interstate, and local highways are issued through the Permit Unit of the Motor Carriers Service Section of the Division of Motor Vehicles (DMV). Applications can be submitted on-line, by mail, or in person.

Wisconsin offers both single trip and multiple trip permits; each with various load-specific permit subtypes. Single trip permits (s.348.26) are valid for two weeks, must travel an approved route, and include four categories: Nondivisible, Manufactured Housing, Building Movers, and Special Hauling Rig. Multiple trip permits (s.348.27) are valid from 3 to 12 months, routed by carriers, and include 17 categories.

WisDOT permit staff currently consists of one supervisor, one technical lead worker, and six processors; with an automated permitting system. Popular multiuse and single-trip permits from the DMV can be issued through an automated extranet program which includes a tool that provides applicants with the latest information on allowable routes, posted structures, and business rules



that may dictate where and when they can operate. Permits can be automatically issued to applicants that define vehicle specifications to a sufficient degree, and are able to locate an acceptable route, following a review by the WisDOT regional engineers for each region the route passes through. Regional engineers will apply local knowledge of the roadway geometrics, traffic volumes and patterns, and structures to approve the route. In some cases, they may apply additional conditions to the permit, such as limiting the time of day for operation. OS/OW permits for vehicles that exceed certain thresholds require additional analysis, which may involve bridge, pavement, and more extensive involvement from regional/local engineers.

**Figure 1.4 Wisconsin Permitting Process Overview**

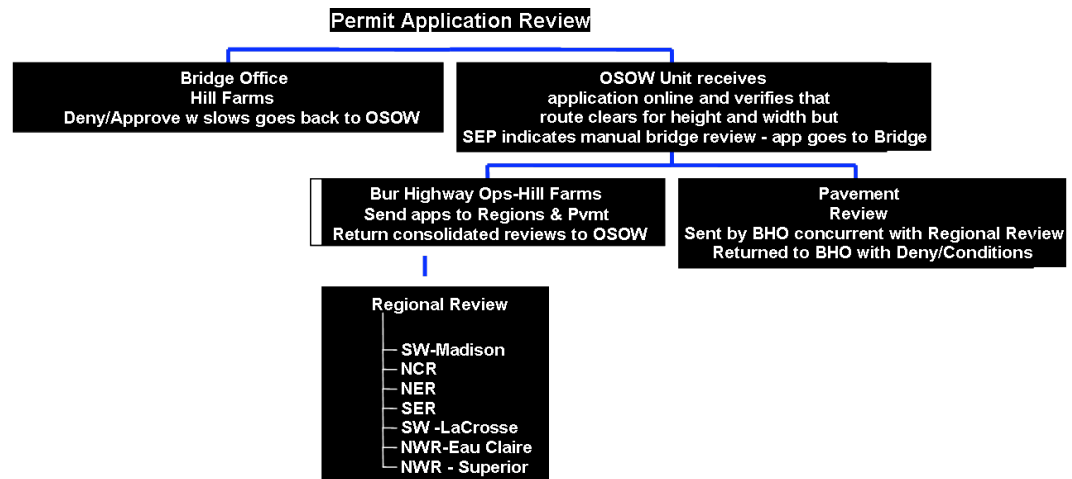

Source: “OS/OW Permitting – Wisconsin” presentation by Kathleen Nichols, Permit Unit Supervisor,  
Abbreviations: SEP = Structural Evaluation Program, Bur = Bureau, BHO = Bureau of Highway Operations,  
SW = Southwest Region, NCR = North Central Region, NER = North East Region, SER = Southeast Region,  
NWR = Northwest Region.

As a requirement of most OS/OW permits issued by the DMV, haulers will have to seek the approval of local management agencies to operate on roadways within their jurisdiction.<sup>10</sup> The rights of local agencies to deny OS/OW operation on their roadways is not limited to local and county roads, but also includes state, U.S., and Interstate highways within their jurisdiction. These rights are not standard in many states. Wisconsin may, in fact, be unique in the powers granted local management agencies. While this represents a potential source of conflict, there has been little precedent for local and county authorities denying OS/OW permits issued through the DMV. This conflict may play a larger role in future OS/OW permitting practices as local management agencies continue to face constrained budgets for roadway maintenance and construction.

<sup>10</sup>Several exceptions are included in Wisconsin Law (348.27). One exception worthy of note is that the permitting power for loads of mobile homes, manufactured homes, and modular homes lies with the State and overrides any local objections.

Local agencies (including regions, counties, cities, villages, and towns) have the authority to issue single trip OS/OW permits for any roadways within their jurisdiction. The level of impact analysis and the sophistication of the permitting process varies greatly from community to community.

### **Permit Fees**

Single trip fees for oversize loads range between \$15 to \$25. Overweight fees are \$20 to \$85 plus \$10 per 10k over 150k. Bridge review is required for loads over 130k and costs \$5. There is no charge for pavement review (required for loads greater than 270k), and the traffic engineering fee is \$10. In 2007, there were 32,000 single trip permits issued in Wisconsin. Multiple trip permits are \$200 to \$1,050 for overweight loads, and \$40 to \$90 for oversize loads. Multiple trip permits issued in Wisconsin numbered 15,000 in 2007.

Additional charges include a regional traffic engineer review fee of \$10 per region of travel, a bridge review fee of \$10 per permit for GVWs of 130,000 or more, and an on-line convenience fee of \$1.00.

### **Exceptions**

This section summarizes the principal exceptions to the commercial vehicle size and weight laws presented above. This list of exceptions is by no means exhaustive; its general intent is to document those circumstances where the existing statute allows current limits to be exceeded, either under permit or not. The emphasis on this list is privately owned and operated commercial vehicles engaged in freight movement; it does not attempt to document the exceptions for passenger transport (motor coaches) or vehicles owned by political subdivisions or utilities related to the everyday maintenance of sanitation power, water, sewage, and like systems. Seasonal weight changes are also documented in this section.

Table 1.2 summarizes the load-specific exceptions to TSW laws. Each of these exceptions is explained in greater detail.

**Table 1.2 Load-Specific Exceptions in Wisconsin Law**

Load	No Permit Required		Permit Required
	Size	Weight	Weight
Automobile Transport	L		
Dairy		X	
Forest Products	W	X	X
Grain, Coal, Iron	L		X
Granular Roofing			X
Hay (and Xmas Trees)	W		
Husbandry	W,H,L		
Livestock	L	X	
Potatoes (Seed and Bulk)			X
Scrap	L		X
Septage		X	
<b>Special</b>			
Long Truck Routes	L		
Michigan-Wisconsin Border	L		X
Fall Agricultural	Seasonal weight exceptions for corn, soybeans, potatoes, and cranberries.		

L = Length, W = Width, H = Height, and X = Weight.

The following exceptions are organized by width, height, length, overall size, and weight.

### *Width*

**Implement of Husbandry Width Exception - (348.05(2)(a)).** There is no width limitation for implements of husbandry temporarily operated upon a highway in the course of performance of its work.

**Farm Tractor Width Exception to 12 feet - (348.05(2)(c)).** Farm tractors are allowed to have a width of 12 feet, except when operating on Wisconsin highways, where the width limit is 9 feet. The 9 foot limit applies to all highways, except a portion of U.S. 51 between Wausau and WIS 78 and that portion of WIS 78 between U.S. 51 and the I-90/94 interchange near Portage upon their Federal designation as I-39<sup>11</sup>, that are a part of the national system of interstate and defense highways.

**Vehicles Carrying Tie Logs, Tie Slabs, and Veneer Logs Width Exception to 9 feet - (348.05(2)(k)).** Vehicles carrying tie logs, tie slabs, and veneer logs can have a width up to 9 feet, provided that no part of the load extends more than

<sup>11</sup>Several exceptions to the restrictions of the national system of interstate and defense highways were “grandfathered” in for those roadways officially designated I-39 in 1992.

six inches beyond the fender line of the left side of the vehicle or extend more than 10 inches beyond the fender line on the right side of the vehicle. This exception does not apply to transport on highways designated as parts of the national system of interstate and defense highways.

***Vehicles carrying loads of hay in bales and Christmas Trees to 12 feet - (348.05(2)(L)).*** There is a width exception of 12 feet for all loads of hay in bales and, from September 15 to December 15 each year, loads of Christmas trees from the point of harvesting or staging to the point of commercial shipment. However, the total outside width of the loads cannot exceed the width of a single traffic lane of any highway over which the loads are carried. This exception applies to vehicles operating on all state and local roads excepting highways designated as parts of the national system of interstate and defense highways.

***Farm tractor, Farm Machinery, and Implements of Husbandry General Width Exception - (348.05(3)).*** Farm tractors exceeding 12 feet in width and not in operation may be moved, towed, or hauled over the highways without a special permit between one-half hour before sunrise and sunset Monday-Thursday and from one-half hour before sunrise to 2:00 p.m. on Fridays. The same applies for all other farm machine and implements of husbandry exceeding 8 feet 6 inches. This does not apply to any Wisconsin highway, except a portion of U.S. 51 between Wausau and WIS 78 and that portion of WIS 78 between U.S. 51 and the I-90/94 interchange near Portage upon their Federal designation as I-39, which is a part of the national system of interstate and defense highways.

***Farm Machinery Permits for Width Exceptions - (348.27(14)).*** This annual or consecutive month permit allows the hauling of tractors exceeding 12 feet in width and the hauling of all other farm machinery and implements of husbandry exceeding 8 feet 6 inches in width. This permit allows the aforementioned overwidth vehicles onto the highways designated as part of the national system of interstate highways. A permit is not required to move, tow, or haul any overwidth machinery that is not a commercial motor vehicle on U.S. 51 between Wausau and WIS 78 and that portion of WIS 78 between U.S. 51 and the I-90/94 interchange near Portage upon their Federal designation as I-39.

### *Height*

***Implements of Husbandry Height Exception - (348.06(2)).*** Implements of husbandry of any height may be temporarily operated upon a highway without a permit for excessive height.

## Length

The Secretary of Transportation has the ability to designate specific highways for exceptions as follows (348.07(2)(im)):

- Highways that have no overall length limit for a tractor-semitrailer combination, a double bottom, or an automobile haul-away;
- Highways that have no overall length limit for a tractor or road tractor when it is operated in a tractor-semitrailer combination, part of a double bottom, or an automobile haul-away;
- Length limit on highways of 28 feet 6 inches for a semitrailer or trailer operated as part of a double bottom; and
- Length limit on highways of 53 feet for a semitrailer whose length from the kingpin to the axle does not exceed 43 feet and which is operated as part of a two vehicle combination. These length limits do not apply to the livestock exemption.

WisDOT publishes maps that outline which roads follow the limits described above, 75 foot limits, 65 foot limits, and others. This requirement is published in Statute 348.07(5). Figure 1.1 displays the latest version of the WisDOT Long Truck Routes Map. This map is included to provide a sample view of the network of Designated Long Truck Routes (green lines), 75 Foot Restricted Routes (blue lines), and 65 Foot Restricted Routes (red lines). For greater detail this map can be viewed on-line at <http://www.dot.wisconsin.gov/travel/maps/truck-routes.htm>.

Load-specific length limit exceptions codified in law include the following:

- **Implements of Husbandry Length Exception - (348.07(2)(e)).** There is no length limitation for implements of husbandry temporarily operated on a highway.
- **Livestock Length Exception - (348.07(2)(im)).** The length limit for a two-vehicle combination designed and primarily used for transporting livestock is 75 feet. The trailer or semitrailer cannot be longer than 53 feet, the trailer/semitrailer must have two axles, and the towing vehicle must be a motor truck, truck tractor, road tractor, or combination vehicle with a gross weight of 10,000 pounds or less.
- **Automobile Haulaway Exception - (348.07(2)(j)).** The length limit for an automobile haulaway is 66 feet plus an additional overhang of 4 feet to the front of the vehicle and 5 feet to the rear of the vehicle.
- **Michigan-Wisconsin Border Length Exception - (348.27(9)(a)).** This annual or consecutive permit allows trucks exceeding statutory length to operate within 11 miles of the Michigan-Wisconsin state line. The following conditions apply:

- Vehicle cannot violate length limits established, as of April 28, 2004, under Michigan Law;
- Valid on any class of Wisconsin highway; and
- If the vehicle is transporting exclusively peeled or unpeeled forest products cut crosswise, wood chips, or forestry biomass, the 11-mile limit does not apply, and vehicles with permits can operate on other specified roads. This includes travel anywhere on U.S. 2 in Iron or Ashland counties as well as on U.S. 2 in Bayfield County, from the Ashland County line through Hart Lake Road.

Note: This statute also creates an exception for vehicles that exceed weight regulations. This exception is covered in the “Weight” section.

- **Scrap Length Exception - (348.27(9r)).** This annual or consecutive permit allows vehicles to exceed statutory length limits for the transport of metallic or nonmetallic scrap for the purpose of recycling or processing. This does not apply to the national system of interstate and defense highways, except a portion of U.S. 51 between Wausau and WIS 78 and that portion of WIS 78 between U.S. 51 and the I-90/94 interchange near Portage upon their Federal designation as I-39. Note: This statute also creates an exception for vehicles that exceed weight regulations. This exception is covered in the “Weight” section.
- **Grain, Coal or Iron Length Exception - (348.27(10)).** This annual or consecutive permit allows vehicles to exceed statutory length limits for the transport of grain, coal, iron ore concentrates, and alloyed iron on a vehicle or a combination of 2 or more vehicles. This transport is allowable over any class of highway for a distance not to exceed five miles from the Wisconsin state line. However, this permit does not apply to highways designated as part of the national system of interstate and defense highways. Note: This statute also creates an exception for vehicles that exceed weight regulations, which is covered in the “Weight” section.

Figure 1.5 2008 Wisconsin Long Truck Operators Map

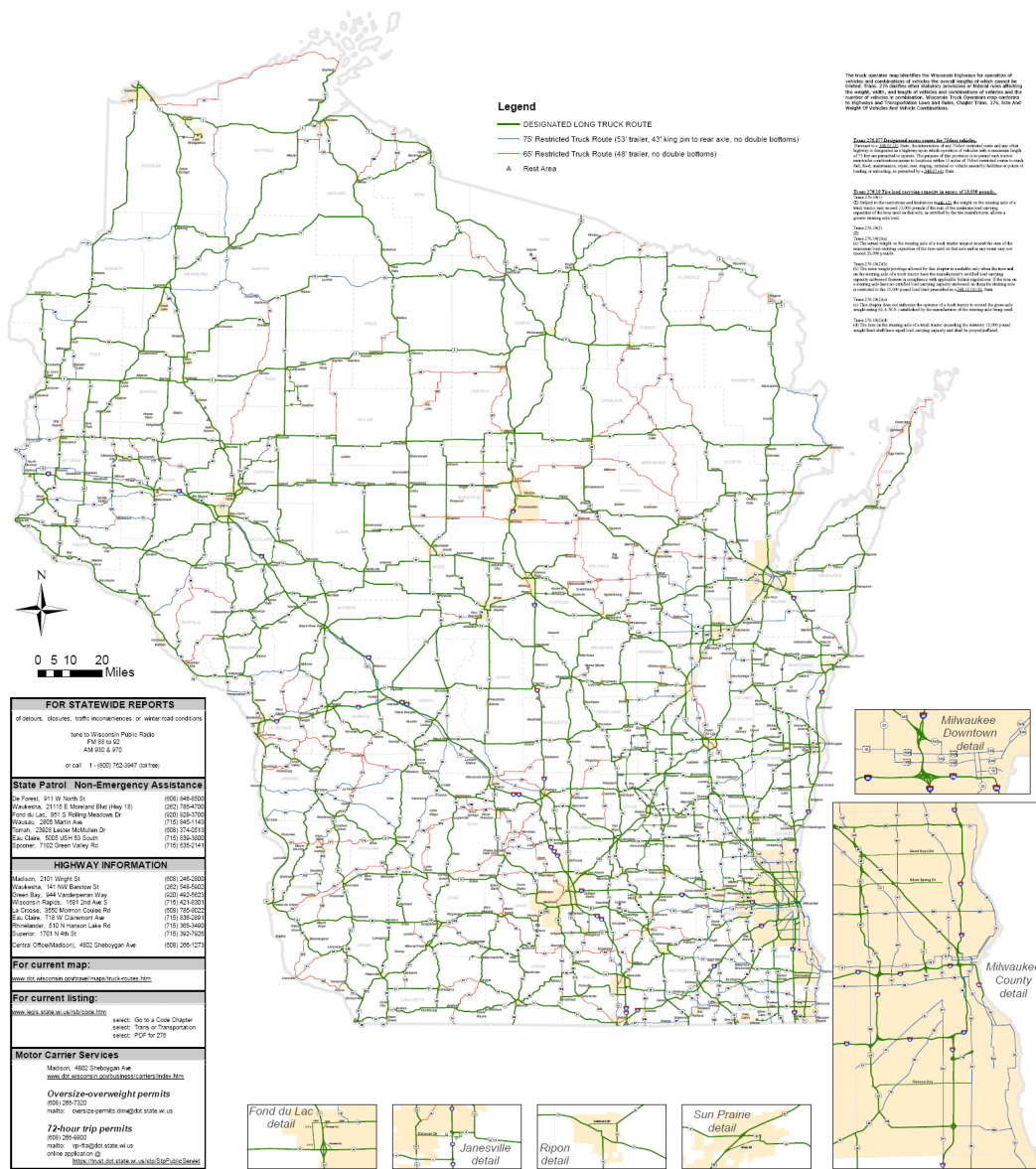

Overall Size

**Industrial interplant permits - (348.27(4)).** These may be issued, as annual or consecutive month permits, to industries and their agent motor carriers owning and operating oversize vehicles. This permit allows interplant and plant-to-state line operations. If traveling on the national system of interstate and defense highways, vehicles or loads cannot exceed 102 inches in width (This does not include that portion of U.S. 51 between Wausau and WIS 78 and that portion of WIS 78 between U.S. 51 and the I-90/94 interchange near Portage upon their Federal designation as I-39). Also, if the routes desired to be used involve city or village streets, or county or town highways, the application must be

accompanied by a written statement of route approval by the officer in charge of maintenance of the highway in question.

### *Weight*

The weight exceptions are organized by several subcategories, including load-specific exceptions with no permit required, load-specific exceptions with permit required, and seasonal weight limitations.

One universal (nonload-specific) weight limit exception is the allowance of an additional 400 pounds of GVW for vehicles equipped with idle reduction technology.

#### **Load-Specific Weight Exceptions (No Permit Required)**

***Dairy Products*** - (348.15(3)(bg)). Loads of dairy products are allowed to be transported on Class A highways with the following axle weights:

- Gross weight imposed on the highway by the wheels of any one axle may not exceed 21,000 pounds;
- For two axles eight or less feet apart, 37,000 pounds; and
- For groups of three or more consecutive axles more than nine feet apart, 2,000 pounds more than is usually allowed (depending on the distance between foremost and rearmost axles in a group) is allowed.

However, total weight cannot exceed 80,000 pounds. This statute does not apply to any Wisconsin highway, except a portion of U.S. 51 between Wausau and WIS 78 and that portion of WIS 78 between U.S. 51 and the I-90/94 interchange near Portage upon their Federal designation as I-39, that is a part of the national system of interstate and defense highways.

***Forest Products*** - (348.15(3)(br)). Loads of forest products are allowed to be transported on Class A highways with the following axle weights:

- Gross weight imposed on the highway by the wheels of any one axle may not exceed 21,500 pounds;
- For two axles 8 or less feet apart, 37,000 pounds; and
- For groups of three or more consecutive axles more than 9 feet apart, 4,000 pounds more than is usually allowed (depending on the distance between foremost and rearmost axles in a group) is allowed.

However, total weight cannot exceed 80,000 pounds. This does not apply to any Wisconsin highway, except a portion of U.S. 51 between Wausau and WIS 78 and that portion of WIS 78 between U.S. 51 and the I-90/94 interchange near Portage upon their Federal designation as I-39, that is a part of the national system of interstate and defense highways.

***Septage*** - (348.15(3)(bv)). Vehicles hauling septage are allowed to be operated on Class A highways with the following axle weights:

- Gross weight imposed on the highway by the wheels of any one axle may not exceed 21,500 pounds (total GVW may not exceed 80,000);



- For two axles eight or less feet apart, 37,000 pounds;
- For groups of three or more consecutive axles more than nine feet apart, 4,000 pounds more than is usually allowed (depending on the distance between foremost and rearmost axles in a group) is allowed;
- For groups of four or more consecutive axles more than 10 feet apart, 6,000 pounds more than is usually allowed (depending on the distance between foremost and rearmost axles in a group) is allowed; and
- For groups of five or more consecutive axles more than 14 feet apart, 7,000 pounds more than is usually allowed (depending on the distance between foremost and rearmost axles in a group) is allowed.

*Livestock* – (348.15(3)(e)). Livestock transports on Class A roads are allowed to exceed the axle weight limits by 15 percent. This is allowable as long as the gross weight does not exceed the weight specified for that vehicle (dependent on the distance between foremost and rearmost axles in a group, not to exceed 80,000 pounds). This does not apply to the national system of interstate and defense highways, except a portion of U.S. 51 between Wausau and WIS 78 and that portion of WIS 78 between U.S. 51 and the I-90/94 interchange near Portage upon their Federal designation as I-39.

#### **Load-Specific Weight Exceptions (Permit Required)**

For the following load-specific weight exceptions, Wisconsin Law grants greater authority for overweight permitting to the State (issued by the Division of Motor Vehicle's Oversize/Overweight (OS/OW) Permit Office). Though local management agency approval is required for many of these permits, vehicle operators apply for OS/OW permits through the State and in many cases the State has the authority to override the objections of local and county management agencies (see 348.27-348.28 for greater detail).

*Michigan-Wisconsin Border Weight Exception* – (348.27(9)(a)). This annual or consecutive permit allows overweight trucks to operate within 11 miles of the Michigan-Wisconsin state line. The following conditions apply:

- Overweight vehicle cannot violate weight established, as of April 28, 2004, under Michigan Law;
- Valid on any class of Wisconsin highway; and
- If the vehicle is transporting exclusively peeled or unpeeled forest products cut crosswise, wood chips, or forestry biomass, the 11-mile limit does not apply, and vehicles with permits can operate on other specified roads. This includes travel anywhere on U.S. 2 in Iron or Ashland counties as well as on U.S. 2 in Bayfield County, from the Ashland County line through Hart Lake Road.

Note: This statute also creates an exception for vehicles that exceed length regulations. This exception is covered in the "Length" section.

*Raw Forest and Agricultural Products (Field to Storage/Processing Facilities) Weight Exception* – (348.27(9m)(a)1). This annual or consecutive permit allows gross weight limitations (depending on the distance between foremost and

rearmost axles in a group) to be exceeded by 10,000 pounds, with a maximum of 90,000 pounds GVW, for raw forest products, fruits or vegetables. The transport for this permit must be from field to storage/processing facilities. This designation is not valid on highways designated as part of the national system of interstate and defense highways, except on I39 between WIS 29 south of Wausau and the I-90/94 interchange near Portage in Marathon, Portage, Waushara, Marquette, and Columbia counties. This permit is not valid for transporting raw forest products after January 1, 2011.

**Raw Forest Products (General) Weight Exception - (348.27(9m)(a)4).** This annual or consecutive permit allows gross weight limitations (depending on the distance between foremost and rearmost axles in a group) to be exceeded by 18,000 pounds for the transport of raw forest products. The following conditions apply:

- The vehicle combination must have six or more axles;
- The gross weight imposed on the highway by the wheels of any one axle of the vehicle combination cannot exceed 18,000 pounds;
- The gross weight imposed on the highway by the wheels of any steering axle on the power unit may not exceed 13,000 pounds or the manufacturer's rated capacity, but not to exceed 18,000 pounds;
- In order to be counted as an axle, the axle must impose at least 8 percent of the gross weight of the vehicle on the highway;
- This permit is not valid on the national system of interstate highways, any highway or bridge with a posted weight limitation that is less than the vehicle's gross weight, and any state trunk highway system on which the DOT has determined that this permit is not valid; and
- The maximum gross weight allowed under this permit is 98,000 pounds.

**Bulk Potatoes (Storage to Rail) Weight Exception - (348.27(9m)(a)2)** This annual or consecutive permit allows gross weight limitations (depending on the distance between foremost and rearmost axles in a group) to be exceeded by 10,000 pounds, with a maximum of 90,000 pounds GVW, for bulk potatoes being moved from storage facilities to rail loading facilities. This permit is valid *only* U.S. 51 between CTH "V" and CTH "B" in Waushara and Portage Counties, and for a distance not to exceed 15 miles from that portion of U.S. 51 for reasons such as food, fuel, or maintenance.

**Bulk Potatoes (Storage to Food Processing Facilities) Weight Exception - (348.27(9m)(a)3).** This annual or consecutive permit allows gross weight limitations (depending on the distance between foremost and rearmost axles in a group) to be exceeded by 10,000 pounds, with a maximum of 90,000 pounds GVW, for bulk potatoes being moved from storage facilities to food processing facilities. This permit is not valid on highways designated as part of the national system of interstate and defense highways.

**Potatoes (For Use as Seed) Weight Exception - (348.27(9t)).** This annual or consecutive permit allows gross weight limitations (depending on the distance between foremost and rearmost axles in a group) to be exceeded by 10,000

pounds, with a maximum of 90,000 pounds GVW, for transporting potatoes intended for use as seed. This permit is valid during spring thaw conditions. This permit only authorizes transport of potatoes on WIS 64 between CTH “H” and U.S. 41 in Langlade, Oconto, and Marinette counties; U.S. 41 between WIS 64 and the Wisconsin-Michigan border; and any highway within 15 miles of any portion of WIS 64 or U.S. 41 specified in this subsection in order to access such necessities as food and fuel.

**Scrap Weight Exception - (348.27(9r)).** This annual or consecutive permit allows vehicles to exceed statutory weight limits for the transport of metallic or nonmetallic scrap for the purpose of recycling or processing. This does not apply to the national system of interstate and defense highways, except a portion of U.S. 51 between Wausau and WIS 78 and that portion of WIS 78 between U.S. 51 and the I-90/94 interchange near Portage upon their Federal designation as I-39. Note: This statute also creates an exception for vehicles that exceed length regulations, which is covered in the “Length” section.

**Grain, Coal or Iron Weight Exception - (348.27(10)).** This annual or consecutive permit allows vehicles to exceed statutory weight limits for the transport of grain, coal, iron ore concentrates, and alloyed iron on a vehicle or a combination of 2 or more vehicles. This transport is allowable over any class of highway for a distance not to exceed 5 miles from the Wisconsin state line. However, this permit does not apply to highways designated as part of the national system of interstate and defense highways. Note: This statute also creates an exception for vehicles that exceed length regulations, which is covered in the “Length” section.

**Garbage and Refuse Annual Permits - (348.27(12)).** This annual permit allows vehicles to exceed statutory weight limits for the transport of garbage and refuse. Permits are issued by the DOT but allow for overweight operation on local highways, negating the authority of local roadway management agencies to refuse overweight operation.

**Granular Roofing Material Weight Exception - (348.27(15)(a)).** This multiple trip permit allows gross weight limitations (depending on the distance between foremost and rearmost axles in a group) to be exceeded by 10,000 pounds, with a maximum GVW of 90,000 pounds, for transport of granular roofing material. This type of permit can only be issued by the DOT, regardless of the highways used. This is not valid on highways designated as part of the national system of interstate and defense highways.

### **Seasonal Weight Limitations**

**Fall Agricultural Exception - (348.17(5)).** From September 1 to November 30 of each year, no permit is required for the transportation of corn, soybeans, potatoes, vegetables, or cranberries to and from the following locations:

- From the field to the grower’s owned or leased land;
- From the field to initial storage at a location not owned or leased by the grower; and
- From the field to initial processing.

This rule applies to vehicles weighing 50,000 pounds or more that exceed gross weight limitations (depending on the distance between foremost and rearmost axles in a group) by not more than 15 percent. This exemption does not apply to the national system of interstate and defense highways, except for that portion of I-39 between U.S. 51 and I-90/94.

**Septic Loads Exception - (349.16(3)).** Vehicles transporting material pumped from a septic or holding tank are exempt from special or seasonal weight limitations in certain instances. Operators are required to notify the authorities in charge of maintenance within 72 hours after operating a vehicle that exceeds special or seasonal weight limitations.

**Frozen Road Declaration.** During the Frozen Road Declaration, which typically lasts from late December to mid to late March, vehicles carrying raw forest products (limited to lumber) and abrasives or salt can operate at weights in excess of standard limitations. Operation is limited to roadways or areas of the State which are determined by local management engineers to be sufficiently frozen that excess weights will not cause damage. In practice, this allows for the routine operation of vehicles fitting the overweight permit requirements outlined above which allow five-axle trucks to operate at 90,000 pounds when hauling raw forest products, fruits or vegetables, and six-axle trucks to operate at 98,000 when hauling lumber, salt, and abrasives [see (348.27(9m)(a)1) and (348.27(9m)(a)4)] for the duration of the Frozen Road Declaration. WisDOT has restricted access to these overweight permits in the one- to two-week period following Frozen Road Declaration but preceding Spring Thaw conditions since 2000, when it was determined that damage was occurring during this vulnerable period for roadways.

**Spring Thaw Restrictions.** Statute 349.16 allows the DOT to restrict travel on roads because of Spring Thaw. During this time period, permits allowing transport of overweight divisible loads are suspended, while permits relating to nondivisible loads are restricted to certain routes. Permit type MI, which allows overweight travel near the Michigan border, is still allowed to some capacity. The permit allowing overweight transport of potato seed is also allowed during Spring Thaw<sup>12</sup>.

Spring Thaw typically begins in early March and ends in mid May. During Spring Thaw, additional restrictions are placed on Class II roads and Springtime posted roads. Overweight permits are not allowed on Class II roads during Spring Thaw. Class II roads, which are determined to have unstable roadway subgrades, accounted for approximately 12 percent of all state highways in 2008. They differ from Class B highways, which restrict maximum allowable vehicle weights for the entire year to 60 percent of the weights allowable on Class A highways. Springtime posted roads are in even poorer condition than Class II roads and are posted during the Spring Thaw to limit trucks to weights below the legal limits which apply to nonposted roadways. Springtime posted roads represented approximately 2 percent of all state highways in 2008.

---

<sup>12</sup><http://www.dot.wisconsin.gov/business/carriers/osow-divisible.htm>.

## 1.4 CONCLUSIONS

The movement of commercial goods is vital to Wisconsin's economy. The volume and weight of goods moved by trucks continues to rise, putting pressure on the transportation network to provide safe and efficient transportation options. The laws governing commercial vehicle size and weight are intended to preserve Wisconsin's highway infrastructure from undue damage from oversize and overweight vehicles.

Comprehensive regulation of truck size and weights requires a balance of the needs and goals of several agencies. State and local transportation agencies seek to preserve infrastructure and promote public safety. They rely upon a system of truck size and weight regulations and enforcement of these regulations through the State Patrol. Oversize and overweight permits, issued through both local and county agencies as well as WisDOT's DMV, accommodate industry needs and allow for the flexibility to accommodate economic growth.

## 1.5 APPENDIX 1A – DEFINITIONS

**Axle** - The common axis of rotation of one or more wheels whether power driven or freely rotating, and whether in one or more segments, and regardless of the number of wheels carried thereon.

**Axle Group** - An assemblage of two or more consecutive axles considered together in determining their combined load effect on a bridge or pavement structure.

**Federal Bridge Formula** - A formula used determine the maximum allowable weight that any set of axles on a motor vehicle may carry on a bridge. The formula limits the weight-to-length ratio of a vehicle crossing a bridge by spreading weight over additional axles or by increasing the distance between axles.

**Gross Vehicle Weight** - The weight of a vehicle plus the weight the vehicle is carrying.

**Implement of Husbandry** - Any vehicle used in the process of cultivating, harvesting, or transporting agricultural products, including crops and animals. Common implement of husbandry vehicles include tractors, trailers.

**ISTEA** - An acronym for Intermodal Surface Transportation Efficiency Act of 1991.

**Longer Combination Vehicle (LCV)** - Any tractor and double or triple trailer, or double semitrailer combinations, excluding the STAA authorized twin 28-foot allowed on the NN, with a gross vehicle weight in excess of 80,000 pounds.

**National Network** - The composite of the individual network of highways from each State on which vehicles authorized by the provisions of the STAA are allowed to operate. Includes the Interstate system and additional roadways (specified in Appendix B for Wisconsin).

**Reasonable Access** - Routes between the divided highways of four or more lanes of travel and terminals, facilities for food, fuel, repair, and rest and points of loading and unloading for household goods carriers, livestock carriers, or for the purpose of providing continuity of route.

**Single-Axle** - Includes all wheels whose centers may be included within two parallel transverse vertical planes 40 inches apart.

**Special Hauling Rig** - Unladen vehicle that is either over legal GVW empty or will have over legal weight axles if components of the rig are loaded onto the main trailing deck.

**STAA** - An acronym for the Surface Transportation Assistance Act.

**Tandem Axles** - Two consecutive axles whose centers are spaced more than 40 inches and not more than 96 inches apart.

**Tire Width** - The manufacturer's width as shown on the tire or the width at the widest part of the tire excluding protective side ribs, bars, and decorations.

**Tridem Axles** - Three axles spaced within 9 feet or less.

**Weigh-in-Motion (WIM)** - devices are designed to capture and record <http://en.wikipedia.org/wiki/Truck>  
[http://en.wikipedia.org/w/index.php?title=Axle\\_weight&action=edit&redlink=1](http://en.wikipedia.org/w/index.php?title=Axle_weight&action=edit&redlink=1) and gross vehicle weights as they drive over a sensor.

## 1.6 APPENDIX 1B - WISCONSIN NATIONAL NETWORK ROADWAYS

Table 1.3 shows the National Network roadways of Wisconsin, as defined in CFR 23, Part 658, Appendix A. The Federally-designated routes on Wisconsin's National Network consist of the Interstate System, except as noted, and the following additional highways. This table is current as of September 16, 2008.

**Table 1.3 Wisconsin National Network Roadways**

	<b>Beginning</b>	<b>End</b>
U.S. 2	I-535/U.S. 53 Superior	Michigan State Line Hurley
U.S. 2	Michigan State Line W. of Florence	Michigan State Line E. of Florence
U.S. 8	U.S. 63 Turtle Lake	Michigan State Line Norway Michigan
U.S. 10	U.S. 53 Osseo	I-43 Manitowoc
U.S. 12	I-94/CH "EE" W. of Eau Claire	U.S. 53 Eau Claire
U.S. 12	I-90/94 Lake Delton	End of 4-lane S. of W. Baraboo
U.S. 12	Wisconsin 67 S. Jct. Elkhorn	Illinois State Line Genoa City
U.S. 14	U.S. 51 N. of Janesville	I-90 Janesville
U.S. 14	Wisconsin 11/89 N. of Darien	I-43 Darien
U.S. 18	Iowa State Line Prairie Du Chien	I-90 Madison
U.S. 41	National Avenue Milwaukee	Garfield Avenue Milwaukee
U.S. 41	107 <sup>th</sup> St. Milwaukee	Michigan State Line Marinette
U.S. 45	Illinois State Line Bristol	Wisconsin 28 Kewaskum
U.S. 45	Wisconsin 29 Wittenberg	Michigan State Line Land O'Lakes
U.S. 51	SCL Janesville	U.S. 14 Janesville
U.S. 51	Wisconsin 78 N. of Portage	U.S. 2 Hurley
U.S. 53	U.S. 14/61 La Crosse	U.S. 10 Osseo
U.S. 53	I-94 Eau Claire	I-535/U.S. 2 Superior
U.S. 61	Iowa State Line Dubuque Iowa	Minnesota State Line La Crosse (via Wisconsin 129 Lancaster Byp.)
U.S. 63	Minnesota State Line Red Wing Minnesota	U.S. 2 W. of Ashland
U.S. 141	U.S. 41 Abrams	U.S. 8 Pembine
U.S. 151	Iowa State Line Dubuque Iowa	U.S. 18 E. of Dodgeville
U.S. 151	I-90/94 Madison	U.S. 41 Fond Du Lac
Wisconsin 11	Iowa State Line Dubuque Iowa	U.S. 51 Janesville
Wisconsin 11	I-90 Janesville	U.S. 14/Wisconsin 89 N. of Darien
Wisconsin 11	I-43 Elkhorn	Wisconsin 31 Racine
Wisconsin 13	Wisconsin 21 Friendship	U.S. 2 Ashland
Wisconsin 16	Wisconsin 78 Portage	I-94 Waukesha
Wisconsin 17	U.S. 8 Rhinelander	U.S. 45 Eagle River
Wisconsin 20	I-94 Racine	Wisconsin 31 Racine
Wisconsin 21	Wisconsin 27 Sparta	U.S. 41 Oshkosh
Wisconsin 23	Wisconsin 32 N. of Sheboygan Falls	Taylor Dr. Sheboygan
Wisconsin 26	I-94 Johnson Creek	Wisconsin 16 Watertown
Wisconsin 26	U.S. 151 Waupun	U.S. 41 SW. of Oshkosh

	<b>Beginning</b>	<b>End</b>
Wisconsin 27	U.S. 14/61 Westby	U.S. 10 Fairchild
Wisconsin 28	U.S. 41 Theresa	U.S. 45 Kewaskum
Wisconsin 29	I-94 Elk Mound	U.S. 53 Chippewa Falls
Wisconsin 29	Wisconsin 124 S. of Chippewa Falls	U.S. 41 Green Bay
Wisconsin 30	U.S. 151 Madison	I-90/94 Madison
Wisconsin 31	Wisconsin 11 Racine	Wisconsin 20 Racine
Wisconsin 32	Wisconsin 29 W. of Green Bay	Gillett
Wisconsin 34	Wisconsin 13 Wisconsin Rapids	U.S. 51 Knowlton
Wisconsin 42	I-43 Manitowoc	Wisconsin 57 SW. of Sturgeon Bay
Wisconsin 47	U.S. 10 Appleton	Wisconsin 29 Bonduel
Wisconsin 50	I-94 Kenosha	45th Avenue Kenosha
Wisconsin 54	Wisconsin 13 Wisconsin Rapids	U.S. 51 Plover
Wisconsin 57	I-43 Green Bay	Sturgeon Bay
Wisconsin 69	Wisconsin 11 Monroe	CH "PB" Paoli
Wisconsin 73	U.S. 51 Plainfield	Wisconsin 54 Wisconsin Rapids
Wisconsin 78	I-90/94 S. of Portage	U.S. 51 N. of portage
Wisconsin 80	Wisconsin 21 Necedah	Wisconsin 13 Pittsville
Wisconsin 119	I-94 Milwaukee	Wisconsin 38 Milwaukee
Wisconsin 124	U.S. 53 N. of Eau Claire	Wisconsin 29 S. of Chippewa Falls
Wisconsin 139	U.S. 8 Cavour, Forest Co	Long Lake
Wisconsin 145	Broadway Milwaukee	U.S. 41/45 Milwaukee
Wisconsin 172	U.S. 41 Ashwaubenon	CH "x" S. of Green Bay
CH "PB"	Wisconsin 69 Paoli	U.S. 18/151 E. of Verona



## 2.0 Selected Truck Size and Weight Laws in Neighboring States

### 2.1 SUMMARY

The objective of this section is to identify, compare, and contrast Wisconsin's truck size and weight (TSW) laws to states immediately nearby. All of the states selected – Minnesota, Iowa, Illinois, Indiana, and Michigan – share a common border with Wisconsin save for Indiana; but it is not uncommon for commercial vehicles originating, terminating, or engaged in long-haul through trips to travel through a combination of the selected Midwestern states. This task seeks to review TSW laws and practices in these neighboring states and highlight both similarities and key differences.

Overall, this analysis revealed that Wisconsin shares similar TSW laws and regulations to neighboring states. Highlights of findings include the following:

- Differences in size limitations between Wisconsin and neighboring states are minimal. The most notable difference is the allowable length of single unit trucks. Several states allow slightly greater lengths.
- Differences in weight limitations between Wisconsin and neighboring states are minimal, though differences in nonpermitted allowable GVWs with Michigan are significant.
- Longer combination vehicles (LCVs) are not allowed in Wisconsin, Minnesota, or Illinois, but are allowed, with provisions, on the Interstate or National Network (NN) in Iowa, Indiana, and Michigan.
- There are extensive load-specific exceptions in many of the Upper Midwest states. Several common load exceptions include raw forest products, agricultural products, auto haulers, dairy, and septage.
- Permitting fees are consistently low throughout the Upper Midwest, though many states follow different procedures in their pricing structure.
- Established procedures for evaluating exceedingly large load applications, referred to as “Superloads” are in place in Illinois, Indiana, and Michigan. This is germane as Wisconsin has received an increasing number of requests for exceptionally large or heavy loads.
- Wisconsin has similar seasonal weight limit changes to Minnesota.
- Enforcement practices are similar throughout the Upper Midwest though most other states invest more resources into enforcement of truck size and weight regulations than Wisconsin.

## 2.2 METHODOLOGY

This section includes a review of respective truck size and weight information sources for each of the states bordering Wisconsin as a means of comparing specifications and highlighting key differences. Figure 2.1 displays the selected states, which include: Minnesota, Iowa, Illinois, Indiana, and Michigan. A number of publications were used to inform this aspect of the study, among them are the following:

- *Upper Midwest Freight Corridor Study (Midwest University Regional Transportation Center);*
- *Code of Federal Regulations 23, Part 658;*<sup>13</sup>
- *Minnesota Truck Size and Weight Project, Final Report (Minnesota Department of Transportation);*
- *State of Indiana Oversize/Overweight Vehicle Permitting Handbook;*
- *Illinois Department of Transportation, “Understanding the Illinois Size and Weight Laws;”*
- *Iowa Department of Transportation, “Iowa Truck Information Guide;”*
- *Michigan Center for Truck Safety, “Truck Driver’s Handbook” 11<sup>th</sup> Edition;*
- *Regulation of Weights, Lengths, and Widths of Commercial Motor Vehicles (TRB Special Report 267);*
- *Code of Federal Regulations 23, Part 658;*
- *Federal Size Regulations for Commercial Motor Vehicles;*
- *AASHTO Guide for Vehicle Weights and Dimensions*<sup>14</sup>;
- *Wisconsin Department of Transportation and Federal Highway Administration (FHWA) Internet sites; and*
- *Conversations with enforcement and permitting staff in Minnesota, Michigan, Indiana, Illinois, and Iowa.*

Information gathered from the above sources has been organized around several broad categories for each state:

- Limits and Provisions;
- Exclusions and Exemptions;
- Roles and Responsibilities;
- Permit Process; and
- Enforcement.

---

<sup>13</sup>[http://www.access.gpo.gov/nara/cfr/waisidx\\_02/23cfr658\\_02.html](http://www.access.gpo.gov/nara/cfr/waisidx_02/23cfr658_02.html).

<sup>14</sup><http://freight.transportation.org/doc/freight/GuideWeight.pdf>.

**Figure 2.1 Selected States for Truck Size and Weight Review**

## 2.3 FINDINGS

This section provides a summary of truck regulations and enforcement trends across key categories in Wisconsin's bordering states. Federal regulations, as prescribed by the Federal Highway Administration and are detailed in *Code of Federal Regulations 23, Part 658*, tend to dictate broad parameters to be complied with by individual states. These regulations are included to provide a frame of reference when comparing the selected states. The Federal Government has also established the Bridge Formula "to limit the weight-to-length ratio of a vehicle crossing a bridge" on the interstate system. States also utilize this formula to govern bridge loads on specially designated roadways and defer to the formula for maximum axle group weight limitations. For greater detail on Federal regulations and the Federal Bridge Formula see Tech Memorandum 2A.

Table 2.1 displays dimensional guidelines for Wisconsin and neighboring states in five common categories: width, height, single-unit vehicle length, semitrailer

length, and twin-combination trailer length. Exclusions and exemptions for these regulations are described later in detailed state-by-state summaries.

**Table 2.1 Summary of Maximum Dimensions in Wisconsin and Neighboring States**

	Wisconsin	Minnesota	Iowa	Illinois	Indiana	Michigan	Federal
Width (feet)	8.5	8.5	8.5	8.5 (Class I and II)	8.5	8.5 (designated)	8.5
Height (feet)	13.5	13.5	13.5	13.5	13.5	13.5	No Limit
Length (feet)							
Single Unit (Straight Truck)	40	45	41	42	40	40	No Limit
Semitrailer	53	53	53	53	53	50/53	48 Minimum
Twin Combinations Trailer	28.5	28.5	28.5	28.5	28.5	28.5	28 Minimum, No Maximum
LCVs Allowed <sup>15</sup>	No	No	Yes <sup>16</sup>	No	Yes <sup>17</sup>	Yes <sup>18</sup>	Varies by state

Table 2.2 summarizes truck weight laws for each of the selected states. Common five-axle and six-axle configurations are included.

**Table 2.2 Summary of Maximum Commercial Vehicle Weights in Wisconsin and Neighboring States**

		Wisconsin	Minnesota	Iowa	Illinois	Indiana	Michigan	Federal
GVW Interstate	5-Axle Vehicle	80,000	80,000	80,000	80,000 <sup>19</sup>	80,000	80,000	80,000

<sup>15</sup>“ISTEA froze the weights of truck tractors with two or more trailing units operating above 80,000 pounds on the Interstate System at the weight limits actually and lawfully in effect for such vehicles in a State on June 1, 1991. ISTEA also froze the maximum length of the cargo-carrying units of CMVs with two or more such units on the National Network.” Certain longer combination vehicles are allowed in select states with provisions.

<sup>16</sup>Truck tractor and 2 trailing units: 100 feet/129,000 pounds; truck tractor and three trailing units: 100 feet/129,000 pounds; multiple “other vehicles”: 78 feet.

<sup>17</sup>Truck tractor and two trailing units: 106 feet/127,400 pounds; truck tractor and three trailing units: 104.5 feet/127,400 pounds; multiple “other vehicles”: 58 feet.

<sup>18</sup>Truck tractor and 2 trailing units: 58 feet/164,000 pounds; truck tractor and three trailing units: N/A; multiple “other vehicles”: 63 feet.

<sup>19</sup>For Classes I, II, and III roadways.

	6-Axle Vehicle	80,000	80,000	80,000	80,000	80,000	101,400 <sup>20</sup>	80,000
Other State Highways	5-Axle Vehicle	80,000	80,000	80,000	73,280 <sup>21</sup>	80,000	87,400	80,000
	6-Axle Vehicle	80,000	80,000	80,000	73,280	80,000	101,400 <sup>22</sup>	80,000
Axle Weights	Single-Axle Weight	20,000	20,000	20,000	20,000	20,000	20,000	20,000
	Tandem (2-Axle) Weight	34,000	34,000	34,000	34,000	34,000	34,000	34,000
	Tridem (3-Axle) Weight	42,000	42,000	42,500	42,500*	50,000 <sup>23</sup>	42,500*	See Note <sup>24</sup>
Seasonal Limits	Spring Load Restrictions	Yes	Yes	Yes	No	No	Yes - 35%/Axle	Yes
	Winter Weight Increase	Yes <sup>25</sup>	Yes 88,000 (+10%)	No	No	No	No	N/A

Table 2.3 summarizes the permitting standards for each of the selected states. This table is a simplification of the very complicated oversize/overweight permit processes of each state, many of which frequently defer to the Federal Bridge Formula. These values are a general representation of each state's practices. Exceptions and qualifications apply.

<sup>20</sup>Based on axle spacing and tire size.

<sup>21</sup>For other state highways and local roads (not Classes I, II, and III roadways).

<sup>22</sup>Based on axle spacing and tire size.

<sup>23</sup>Subject to Federal Bridge Table, dependent on axle spacing.

<sup>24</sup>No maximum for Tridem Axle groups specifically identified in Federal Regulations, but the Federal Bridge Formula allows for weights between 34,000 and 60,000, depending on spacing of the axle group (measured at the center of the axles).

<sup>25</sup>Pursuant to Frozen Road Declaration.

**Table 2.3 Summary of Permitting Practices for Commercial Vehicle Weights in Wisconsin and Neighboring States**

		Wisconsin	Minnesota	Iowa	Illinois	Indiana	Michigan
Maximum Routine Permit <sup>26</sup>	Gross Vehicle Weight <sup>27</sup>	130k/130k <sup>28</sup>	92k/144k	100k/156k	100k/120k	108k/120k	80k/164k
	Single Axle	35,000 <sup>29</sup>	20,000	20,000	20,000	20,000	13,000
	Double Axle	65,000 <sup>30</sup>	40,000	40,000	34,000	40,000 <sup>31</sup>	26,000
Superload Permitting Procedure <sup>32</sup>		Yes	No	No	Yes	Yes	Yes

Table 2.4 shows the load-specific exceptions for each state. These are simplified notations of the very complex laws which govern allowable truck sizes and weights and are intended only for broad-level comparison. For a detailed treatment of exceptions within each state; see the following sections.

<sup>26</sup>The phrase “Maximum Routine Permit” refers to the upper limit at which the State will issue an automatically-reviewed or standard permit. Any requests for permits above these standards necessitates a more lengthy review, typically involving state and regional engineers, bridge analysis, and/or additional restrictions on time of day or other operating characteristics.

<sup>27</sup>GVWs are shown as 5-axle/6-axle.

<sup>28</sup>130k is the GVW that triggers automated analysis by Structural Evaluation Program (SEP).

<sup>29</sup>20,000 pounds maximum for steer axles.

<sup>30</sup>55,000 pounds tandem axle loads are allowed on nondivisible multiple trip permits.

<sup>31</sup>Subject to Federal Bridge Formula.

<sup>32</sup>“Superload” refers to loads that are exceptionally large or heavy and typically exceed OS/OW permitting standards and often require case-by-case review, which includes addressing engineering assessments of highway infrastructure along the proposed route. The states selected have frequent requests for superload shipments and established systems in place for issuing “Superload” permits, and individual state permit descriptions are included within each state’s section.

**Table 2.4 Load-Specific Exceptions by State**

Load	Wisconsin	Minnesota	Iowa	Illinois	Indiana	Michigan
Agricultural Products	S,W				S, W	S
Automobile Transport	S	S	S	S	S	S
Canola Oil		W				
Concrete Pipe						S
Dairy	W					
Firefighting Equipment					S, W	S, W
Forest Products	S,W					S
Grain, Coal, Iron	S					
Granular Roofing	W					
Highway Construction Equipment			W		S, W	
Husbandry	S		W		S,W	S,W
Livestock	S,W		W			
Paper		W				
Raw or Unprocessed Agricultural	W	S,W			S	
Scrap	S,W					
Septage	W					
Timber/Forest Products	S	S,W				
Waste		W				S

S = Size, W = Weight.

As Wisconsin and its neighboring states rely on a variety of permitting definitions and terminology, administration and enforcement strategies, there tends to be a substantial amount of disparity in permitting approaches and over dimension-over weight regulation in general. Figure 2.2 depicts a hypothetical scenario for permit costs across the six states for a single-trip 100k five-axle load. There are numerous qualifying factors that could cause rates to fluctuate greatly, and the nature of the fee structures and regulations do not lend themselves easily to direct comparison, however, this graphic attempts to broadly capture both the basis for permit costs in each state as well as a sample trip rate. As can be seen, the permit cost for this load can range from \$10 to \$200. Given the increasing pressure on the trucking industry to absorb rising fuel costs and operate on slimmer profit margins, \$100 to \$200 for a single trip load is not necessarily considered a marginal expense.

Figure 2.2 Relative Permit Costs

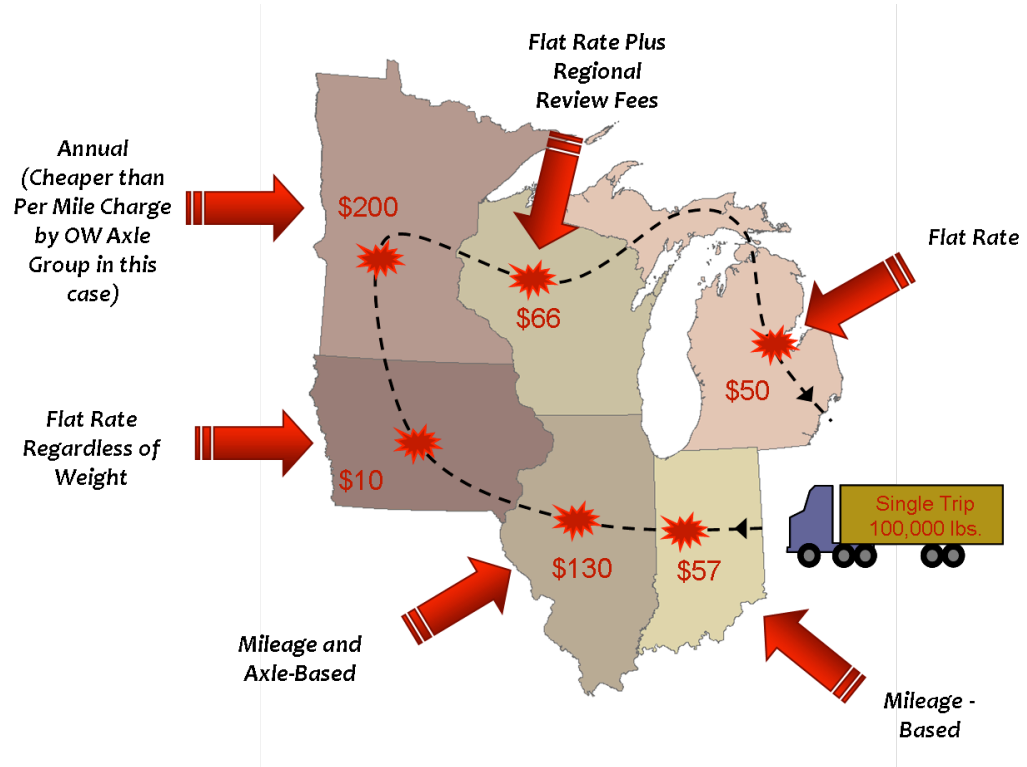



**Figure 2.3 Comparison of Overweight Fines**

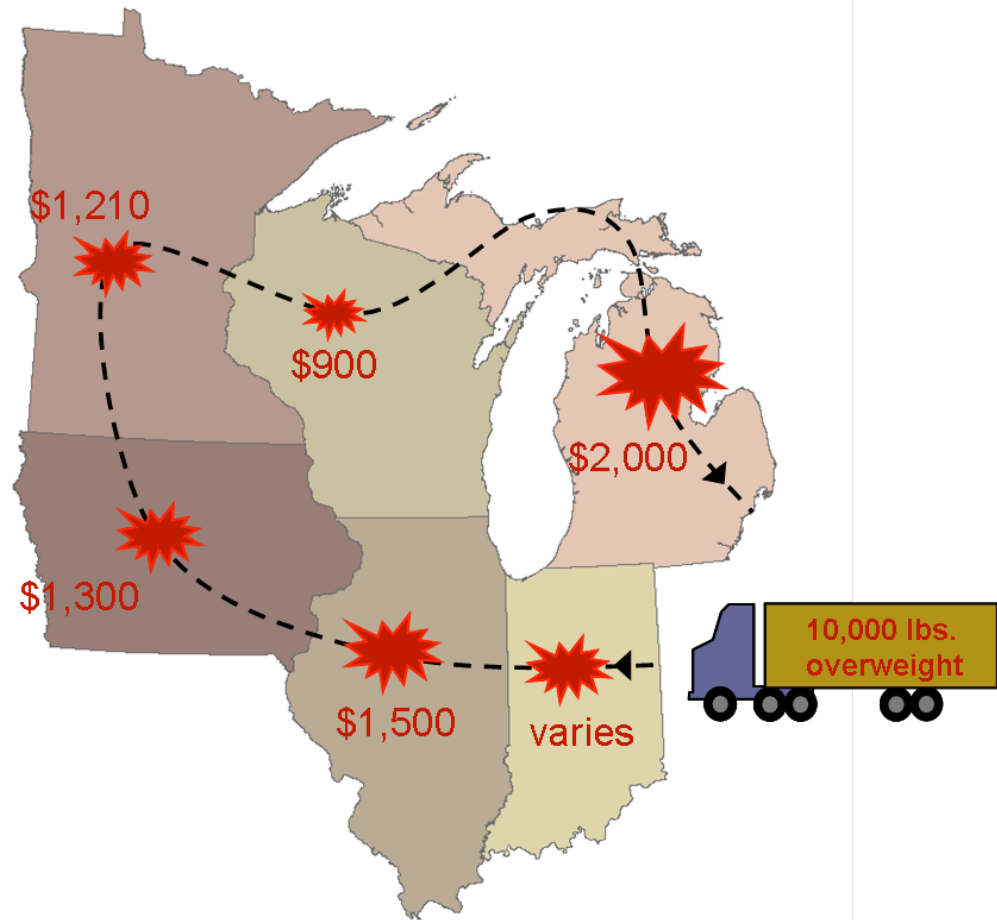

Note: Fees are for initial citation. Do not include subsequent and/or additional court or processing fees. In Indiana, a GVW violation of 10,000 pounds or greater over the maximum is considered a Class A violation (penalties vary).

Truck size and weight laws require enforcement to be effective. Figure 2.3 shows a comparison of the overweight fines a carrier would receive if operating without a permit at 10,000 pounds overweight through the region. As shown in Figure 2.3, Wisconsin's penalty is lowest in the region.

Motor carrier operator and vehicle compliance is subject to regulations which are outlined in the U.S. Code of Federal Regulations parts 395 and 396.<sup>33</sup> Part 395 outlines driver requirements, including hours-of-service information and record of duty status, and also defines "out of service" criteria (395.13). Part 396 focuses on vehicle safety regulations and provides criteria for inspector qualifications, minimum vehicle requirements, and related operational standards. Part 396

<sup>33</sup>Chapter III – Federal Motor Carrier Safety Administration, Department of Transportation. Available at: [http://www.access.gpo.gov/nara/cfr/waisidx\\_04/49cfrv4\\_04.html](http://www.access.gpo.gov/nara/cfr/waisidx_04/49cfrv4_04.html).

authorizes a vehicle to be declared “Out of Service (OOS)” for failing to meet minimum mechanical standards. Table 2.5 displays summary information for Compliance Reviews, Roadside Inspections, and Traffic Enforcement statistics for select Midwest states along with totals for the U.S. in 2007. Compliance Reviews refer to “on-site examinations of a motor carrier’s records and operations to determine whether the carrier meets the FMCSA safety fitness standard.” Roadside Inspections “occur when a MCSAP inspector conducts an examination on individual commercial motor vehicles and drivers to determine if they are in compliance with the Federal Motor Carrier Safety Regulations.” Traffic Enforcement is identified as “an event when at least one traffic violation is present in the inspection. Only those traffic enforcements that initiate a subsequent roadside inspection are included in the MCSAP program.”<sup>34</sup>

By this measure Wisconsin stands out as having far fewer roadside inspections than all surrounding states at 38,000. Illinois and Michigan both exceed 82,000 in this category. Wisconsin is also second only to Iowa in traffic enforcement at 17,451 roadside inspections; Michigan and Indiana recorded 40,000 plus and Illinois was at 28,000.

**Table 2.5 2007 State Program Measures Summary<sup>35</sup>**

	Wisconsin	Minnesota	Iowa	Illinois	Indiana	Michigan	U.S.
Compliance Reviews	206	159	164	248	278	166	9,774
Satisfactory:	68.0 %	75.5 %	56.7 %	58.9 %	75.2 %	63.9 %	65.3 %
Conditional:	28.2 %	18.2 %	39.6 %	38.3 %	18.3 %	35.5 %	26.7 %
Unsatisfactory:	0.0 %	1.9 %	1.8 %	2.8 %	6.1 %	0.6 %	5.5 %
Not Rated:	3.9 %	4.4 %	1.8 %	0.0 %	0.4 %	0.0 %	2.5 %
Roadside Inspections	38,548	50,036	64,227	82,486	74,262	82,975	3,411,914
Driver OOS <sup>a</sup>	6.9 %	8.9 %	9.4 %	7.8 %	10.1 %	6.3 %	6.8 %
Vehicle OOS <sup>b</sup>	23.2 %	22.4 %	27.0 %	23.2 %	29.4 %	19.8 %	22.3 %
Traffic Enforcement	17,451	21,319	14,135	28,509	40,540	40,029	755,376
Driver OOS <sup>a</sup>	8.0 %	9.8 %	8.8 %	9.4 %	11.9 %	7.8 %	10.0 %
Vehicle OOS <sup>b</sup>	24.9 %	38.6 %	31.5 %	21.6 %	36.3 %	21.2 %	28.0 %

<sup>a</sup> Driver OOS Rate is based on inspection levels 1,2,3.

<sup>b</sup> Vehicle OOS Rate is based on inspection levels 1,2,5.

<sup>34</sup>Federal Motor Carrier Safety Administration, Analysis Division.

<sup>35</sup>FMCSA Program Measures Activity Summary, by State 2007. Available at: <http://ai.fmcsa.dot.gov/ProgramMeasures/Intro/ProgramMeasuresMain.asp?ST=IA>

Current Out of Service Orders (OOS) for Wisconsin and surrounding states are shown in Figure 2.4. Categories include: “90-day failure to pay,” “New Entrant Number, Registration Revoked,” “Unsatisfactory Unfit,” and “Imminent Hazard.” Of the states included, Illinois is the clear leader in OSO at slightly over 1,000. Michigan and Minnesota follow at approximately 400 apiece, followed by Indiana and Iowa. Wisconsin has the least number of OSO with less than 100.

**Figure 2.4 Current Out of Service Orders<sup>36</sup>**

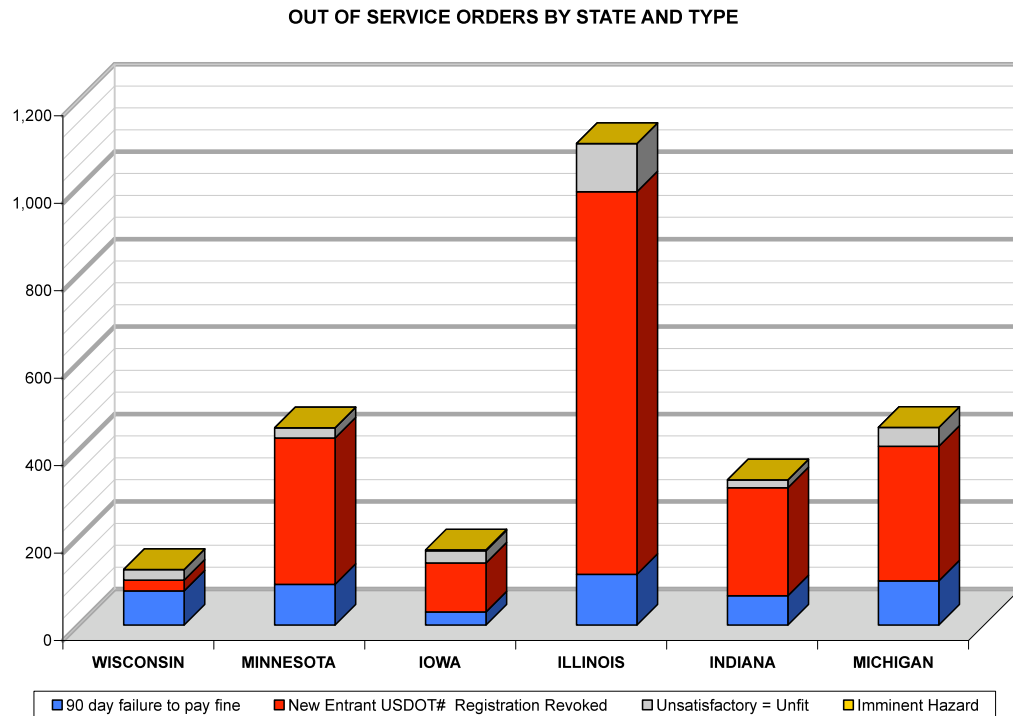

## 2.4 MINNESOTA<sup>37</sup>

### Limits and Provisions

*Dimensions: Same as Wisconsin, except for Single-Unit Vehicles/Straight Trucks*

The maximum allowable height in Minnesota is 13.5 feet. The maximum allowable width is 8.5 feet unless specifically permitted for greater width. Minnesota allows

<sup>36</sup>Inclusive of all carriers who have current Federal Motor Carrier Safety Administration (FMCSA) Out of Service Orders issued against them. Available at: [http://li-public.fmcsa.dot.gov/LIVIEW/pkg\\_oos\\_process.prc\\_oos\\_search](http://li-public.fmcsa.dot.gov/LIVIEW/pkg_oos_process.prc_oos_search).

<sup>37</sup>Laws for Size and Weight in Minnesota are defined in (2007) Statute Section 169.8x.

single unit trucks of up to 45 feet in length. Combination vehicles are limited to 75 feet of overall length. LCVs are not allowed in Minnesota.

**Weight: Same as Wisconsin**

Minnesota roadways divided into two groups. Designated Highways (10-Ton Network) include all State Trunk Highways, all paved County and County State-Aid Highways, and certain other routes designated by the Commissioner of Transportation. 10-ton route weight limits are comparable to Wisconsin’s, while Nondesignated Highways allow slightly lesser weights. See Table 2.6 for a summary of weight limits by roadway class. All routes are subject to a maximum wheel load allowed on the foremost and rearmost steering axles of 600 pounds per inch of tire width or the manufacturers rated load. For all other axles the maximum load is 500 pounds per inch of tire width.

**Table 2.6 Minnesota Weight Limits by Roadway Class**

Weight Limits	Designated Highways	Nondesignated Highways		
	10-Ton Network	9-Ton Network	7-Ton Network	5-Ton Network
GVW	80,000 <sup>a</sup>	73,280 <sup>b</sup> /80,000 <sup>c</sup>	N/A	N/A
Single Axle	20,000	18,000	14,000	10,000
Single Wheel	10,000	9,000	7,000	5,000

<sup>a</sup> Any vehicle combination with five or more axles with minimum spacing.

<sup>b</sup> Any vehicle combination with five or more axles with minimum spacing.

<sup>c</sup> Any vehicle combination with six or more axles with minimum spacing.

Minnesota has a seasonal weight increase of 10 percent on all 10-ton routes, translating to a maximum gross weight of 88,000-pounds, with proper axle spacing. Weight limit increase Minnesota Department of Transportation provides annotated weight table to clarify axle-weight and axle-spacing limits. The table is shown in Figure 2.5.

Figure 2.5 MnDOT Gross Weight Schedule

Axle spacing	Number of Axles							
	2 Ax (9T)	2 Ax (10T)	3 Axles	4 Axles	5 Axles	6 Axles	7 Axles	8 Axles
4	34000	34000						
5	34000	34000						
6	34000	34000						
7	34000	34000	37000					
8	34000	34000	38500					
8 plus	34000	38000	42000					
9	35000	39000	43000					
10	36000	40000	43500	49000				
11			44500	49500				
12			45000	50000				
13			46000	51000				
14			46500	51500	57000			
15			47500	52000	57500			
16			48000	53000	58000			
17			49000	53500	59000			
18			49500	54000	59500			
19			50500	55000	60000			
20			51000	55500	60500	66000	72000	
21			52000	56000	61500	67000	72500	
22			52500	57000	62000	67500	73000	
23			53500	57500	62500	68000	73500	
24			54000	58000	63000	68500	74000	
25			55000	59000	64000	69000	75000	
26			55500	59500	64500	70000	75500	
27			56500	60000	65000	70500	76000	
28			57000	61000	65500	71000	76500	
29			58000	61500	66500	71500	77000	82000
30			58500	62000	67000	72000	77500	82500
31			59500	63000	67500	73000	78500	83500
32			60000	63500	68000	73500	79000	84500
33				64000	69000	74000	79500	85000
34				65000	69500	74500	80000	85500
35				65500	70000	75000	80500	86000
36				66000	70500	76000	81000	86500
37				67000	71500	76500	81500	87000
38				67500	72000	77000	82000	87500
39				68000	72500	77500	82500	88500
40				69000	73000	78000	83500	89000
41				69500	74000	79000	84000	89500
42				70000	74500	79500	84500	90000
43				71000	75000	80000	85000	90500
44				71500	75500	80500	85500	91000
45				72000	76500	81000	86000	91500
46				72500	77000	81500	87000	92500
47				73500	77500	82000	87500	93000
48				74000	78000	83000	88000	93500
49				74500	79000	83500	88500	94000
50				75000	79500	84000	89000	94500
51				76000	80000	84500	89500	95000
52				76500		85000	90500	95500
53				77500		86000	91000	96500
54				78000		86500	91500	97000
55				78500		87000	92000	97500
56				79500		87500	92500	98000
57				80000		88000	93000	98500
58						89000	94000	99000
59						89500	94500	99500
60						90000	95000	100500
61							95500	101000
62							96000	101500
63							96500	102000
64							97000	102500
65								103000
66								103500
67								104500
68								105000
69								105500
70								106000
71								106500
72								107000
73								107500
74								108000

Source: Minnesota DOT, 2008.

Exclusions and Exemptions

There are exceptions to Minnesota’s standard truck size and weight laws in the following cases:

- Public utility vehicles transporting poles which cannot be shortened, or truck transporting pole-length pulpwoods can operate at lengths up to 75 feet.
- Truck tractor and semitrailer combinations exceeding 75 feet in length, including twin-trailer combinations, may be operated on the Twin Trailer Network (divided highways with four or more lanes of travel and on other routes designated by the Commissioner of Transportation.
- There is a statewide system of approved routes which allow 14.5 foot vehicle widths.<sup>38</sup>
- Single unit mobile cranes may operate at 48 feet in length.

<sup>38</sup><http://www.dot.state.mn.us/cvo/oversize/14-6WideLoadsJuly08.pdf>.

- During the Winter Weight Increase, maximum allowable GVW is increased by 10 percent for zones established based on the freezing model each winter. Vehicles carrying raw forest products may operate at 98,000 pounds during the Winter Weight Increase (which matches Wisconsin's exception for raw forest product loads during the Frozen Road Declaration). Nine-ton county roads allow 88,000 pound loads during this period and Interstate routes allow for 88,000 pound loads with a permit.
- During the Harvest Season Weight Increase, the maximum allowable GVW for loads of sugar beets, carrots, and potatoes is increased by 10 percent.
- During Spring Load restrictions, a five-ton axle limit is placed on certain county highways, town roads, or city streets. Local authorities can add additional restrictions on weight during this period.

Minnesota allows exclusions and exemptions to standard TSW laws in the form of annual, load-specific permits:

- Raw or unfinished forest products may be hauled in vehicles operating at up to 90,000 pounds with an annual permit of \$300.
- Vehicles moving implements of husbandry on non-Interstates under 30 mph and within 75 miles of farmland or dealership are exempt from weight restrictions.
- Vehicles hauling livestock may operate under permit at a GVW of up to 88,000 pounds for any vehicle or combination of vehicles with six or more axles while exclusively engaged in hauling livestock on all state trunk highways other than Interstate highways.
- Under permit, a nine-axle combination consisting of a truck tractor and semitrailer drawing one additional semitrailer and an auxiliary dolly (with maximum trailer length of 28 feet 6 inches) is allowed a maximum GVW of 108,000 pounds when carrying special paper products. This configuration is limited to a few key roadways defined in Minnesota Law.
- There is an exception to the relevant evidence required for vehicles transporting the first haul of unprocessed or raw farm products (including milk) or raw and unfinished forest products as long as the weight recorded does not exceed the maximum allowable weight by 10 percent.
- Waste haulers are exempted from variable load axle restrictions when a permit is obtained.

Several additional load-specific permits were added to Minnesota Law in 2008.<sup>39</sup>

- The definition for raw and unfinished forest products used to determine eligibility for the 90,000 pound annual permit (see above) is expanded to include paper, pulp, oriented strand lumber, hardboard, treated lumber, untreated lumber, and barrel staves. These raw or unfinished forest

---

<sup>39</sup>Permit Changes for 2008, Minnesota Department of Transportation.

products may be hauled in vehicles operating at up to 90,000 pounds with an annual permit of \$300.

- A new permit allows the transport of round or square baled hay, straw, or square baled hay, straw, or cornstalks up to 12 feet wide and 14.5 feet high.
- Permits are allowed for loads of agricultural products (raw or unprocessed) to be hauled in commercial vehicles with 6/7 axles at GVWs up to 90,000/□97,000 pounds.
- Agricultural products that are in sealed international intermodal containers and are in international movement may be transported at up to 90,000 pounds.
- An annual permit allows tow trucks to exceed length and weight limitations when towing disabled or damaged vehicles.
- A two-unit permit allows 7 axles with proper spacing to operate at GVWs of up to 97,000 on restricted routes.
- A Canola oil annual permit allows a three-vehicle combination (twin 28.5 feet trailers) with proper spacing to haul up to 105,500-pounds GVW over limited routes from Hallock, Minnesota to North Dakota border. This permit is not valid on Interstate highways or National Truck Network highways.

### *Roles and Responsibilities*

The Minnesota State Patrol, Department of Safety, Commercial Vehicle Enforcement Division is responsible for enforcement of size and weight laws on its highways. The MnDOT Office of Freight and Commercial Vehicle Operations Oversize/Overweight Permit section reviews and administers the permitting system for oversize and overweight vehicles.

### *Permitting Process*

MnDOT Office of Freight and Commercial Vehicle Operations Oversize/□Overweight Permit section issues permits for Interstate, U.S., and state highways. Local roadway authorities maintain jurisdiction over county, city, and local streets. Frequently requested permit types include single trip, job permit, seasonal winter weight increase, sugar beet, potato, carrot harvest, raw forest product annual, refuse compactor truck annual, snow plow truck annual, mobile home annual, construction machinery and supplies annual, mobile crane annual, farm implement annual, farm equipment annual, commercial boat annual, and noncommercial boat annual.<sup>40</sup>

Permit fees are modest and range from \$15 for a single trip of any load type to up to \$300 for special annual permits, such as the permit allowing for raw forest products to be transported at 90,000 pounds.

---

<sup>40</sup>Minnesota Commercial Truck and Passenger Regulations Fact Sheet.

### *Enforcement*

The Commercial Vehicle Enforcement Division of the Minnesota State Patrol uses 15 weigh stations to enforce truck size and weight regulations.

## **2.5 IOWA<sup>41</sup>**

### **Limits and Provisions**

Iowa roadways are categorized into two groups: Primary and Nonprimary. Primary roadways include all state and Federal highways, including the Interstate highway system. Nonprimary roadways are all city and county roadways not included in the Primary roadway class.

*Dimensions: Same as Wisconsin except for slightly longer Single-unit vehicles/□straight trucks*

Iowa law limits vehicle length to 41 feet for single unit trucks (one foot longer than Wisconsin's limit) and 53 feet for semitrailers. There is no overall length limitations on trailer-tractor/semitrailer combinations. Height is limited to 13.5 feet.

*Weight: Same as Wisconsin*

Primary roadways allow for a single axle weight of 20,000 pounds, a tandem axle load of 34,000-pounds, and a maximum GVW of 80,000 pounds.

### *Exclusions and Exemptions*

Several exceptions to Iowa's truck size and weight laws are listed (in simplified form) below.

- Auto transporters hauling passenger vehicles, light delivery trucks, pickup trucks, or recreational vehicle chassis may operate at 14 feet in height.
- Lowboy trailers used exclusively for the transportation of construction equipment may be used in a truck-tractor semitrailer combination with a semitrailer length of 57 feet.
- Stinger steer auto transporters may operate at a length of 75 feet (exceeding semitrailer length limits).
- Six and seven-axle livestock and construction vehicles may operate with a GVW of 90,000/96,000 with approved axle spacing.
- Five-axle livestock transports with a spread-axle trailer may operate with a maximum GVW of 86,000 pounds on all non-Interstate primary roads.

---

<sup>41</sup>Iowa Size and Weight Laws defined (2003) Iowa Code Chapter 321 (321.452-459).



## Roles and Responsibilities

Vehicle size and weight regulations are enforced by the Iowa Department of Transportation's Office of Motor Vehicle Enforcement, while permitting for Over-Dimensional, Overweight Loads, Special Mobile Equipment, and trip permits are administered by the Office of Motor Carrier Services.

## Permit Process

Oversize/overweight permits are issued by the Office of Motor Carrier Services. Iowa issues single trip and annual permits for indivisible loads that exceed legal dimensions. Separate permits are necessary for operations on state, county, and city roads, unless an "All-Systems Permit" is obtained from the state and authorized by participating counties. Table 2.7 shows permit standards and costs. These costs are consistent with other Upper Midwest states.

**Table 2.7 Oversize/Overweight Permit Standards for Iowa**

Oversize/Overweight Permits					
Permit Type	Single Trip	Annual		Annual*** Oversize/Overweight	Multi-Trip
Cost	\$10	\$25		\$300	\$200
Axle Weight	20,000 lbs. per axle *See exception	20,000 lbs. per axle		20,000 lbs. per axle	20,000 lbs. per axle
Gross Weight	No limit	80,000 lbs.		156,000 lbs.	156,000 lbs.
Height	No limit	13'10"	15'5"	15'5"	Unlimited
Length	No limit	120'	120'	120'	120'
Width	No limit	12'5"	16'	13'5"	16'
Interstate Travel	Allowed	Allowed	Allowed	No interstate highway travel over 80,000 lbs.	Allowed
Routing	MCS routing required	MCS routing not required	MCS routing required when loads over 14'6" wide. MCS routing required when loads are over 50-mile radius unless route continues on at least 4-lane roads.	MCS routing not required	Carrier provides route and DOT verifies. Load can change, configuration cannot.
Valid	1 trip in 5 days	12 months from month issued		12 months from issued	60 days
Construction Equipment	Allowed up to 36,000 lbs. single axle; 126,000 gross weight with qualifying tires**	Allowed up to 36,000 lbs. single axle; 80,000 lbs. gross weight with qualifying tires.**		Allowed up to 36,000 lbs. single axle; 126,000 lbs. gross weight with qualifying tires.**	Allowed up to 36,000 lbs. single axle; 126,000 gross weight with qualifying tires**
Carrier Route Check	None	None	None	- Construction and embargo maps - Vertical clearance maps - 156 Kip map - Check with DOT to ensure no changes	None

These permits are valid only for movement on state and federal highways. County and city permits must be obtained separately. \*Exception: cranes with pneumatic tires meeting the definition of an indivisible vehicle may have a maximum of 24,000 pounds per axle, single trip permit and round-trip permits only; and travel is allowed on the interstate system. \*\*Exception: Formula for construction equipment with flotation pneumatic tires: Axle weight=20,000 lbs+(tire width-18) X 1,882 pounds. \*\*\* Vehicles operating under an annual oversize/overweight permit can operate under annuals with no weight guidelines when they can meet the annual permit requirements with no weight dimensions.

Source: Iowa Truck Information Guide 2007.

### *Enforcement*

The Iowa DOT's Office of Motor Vehicle Enforcement operates 16 enforcement scale sites. PrePass is equipped on 5 of the 13 Interstate scales. The additional three scales are off the Interstate system on the Iowa Primary Road system.

## **2.6 ILLINOIS<sup>42</sup>**

### **Limits and Provisions**

Illinois has a roadway classification system consisting of designated highways (Classes I, II, and III), and nondesignated roadways (other state highways, and local roads and streets).

*Dimensions: Same except for longer single-unit vehicle length*

Illinois laws allow for a single vehicle length of 42 feet, two feet longer than Wisconsin laws. A width of 8.5 feet is applicable only to Classes I and II roadways, while a maximum of eight feet is standard for all other roadways.

*Weight: Generally similar to Wisconsin, but lower limits on nondesignated roadways.*

Classes I, II, and III highways carry a GVW maximum of 80,000 pounds, while combination vehicles operating on other State highways and local roads have a 73,280-pound limit. Figure 2.6 below provides a summary graphic of Illinois size and weight laws, organized by vehicle combination.

---

<sup>42</sup>Illinois size and weight laws are defined in Illinois Vehicle Code (625 ILCS 5/Chapter 15). Available at: <http://www.ilga.gov/legislation/ilcs/ilcs4.asp?DocName=062500050HCh.+15+Art.+III&ActID=1815&ChapAct=625%26nbsp%3BILCS%26nbsp%3B5%2F&ChapterID=49&ChapterName=VEHICLES&SectionID=59818&SeqStart=142000000&SeqEnd=144300000&ActName=Illinois+Vehicle+Code>.

**Figure 2.6 Illinois Maximum Truck Configuration and Weight by Roadway Class**

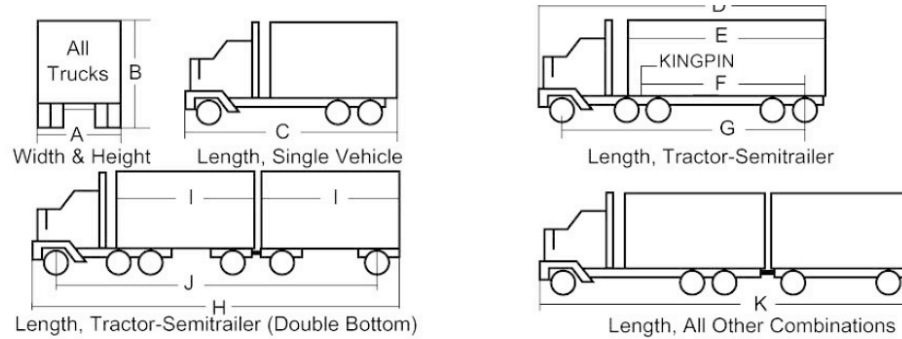

Type of Highway or Street	Maximum Legal Dimensions										Maximum Weights			
	A	B	C	D	E	F <sup>4</sup>	G	H	I	J	K	Single Axle	Tandem Axle <sup>2</sup>	Gross <sup>3</sup>
Class I	8'-6"	13'-6"	42'	N.S.	53'	45'-6"	N.S.	N.S.	28'-6"	N.S.	60'	20,000	34,000	II
Class II	8'-6"	13'-6"	42'	N.S.	53'	45'-6"	N.S.	N.S.	28'-6"	65'	60'	20,000	34,000	II
Class III	8'	13'-6"	42'	65' <sup>1</sup>	53'	42'-6"	55' <sup>1</sup>	60'	N.S.	N.S.	60'	20,000	34,000	II
Other State Highway	8'	13'-6"	42'	65' <sup>1</sup>	53'	42'-6"	55' <sup>1</sup>	60'	N.S.	N.S.	60'	18,000	32,000	III
Local Roads and Streets	8'	13'-6"	42'	55'	N.S.	N.S.	N.S.	60'	N.S.	N.S.	60'	18,000	32,000	III

N.S. indicates legal dimension not specified

**Notes:**

- <sup>1</sup> 65 feet overall length (bumper to bumper) and/or 55 feet from center of front axle to center of rear axle.
- <sup>2</sup> Tandem is defined as any 2 or more single axles whose centers are more than 40 inches and not more than 96 inches apart, measured to the nearest inch between extreme axles.
- <sup>3</sup> See tables II and III on reverse side.
- <sup>4</sup> Applies on semitrailers longer than 48 feet.

Source: Understanding the Illinois Size and Weight Laws.

*Exclusions and Exemptions*

There are few exceptions written into Illinois truck size and weight laws. Illinois handles requests for exceptions to standard limits and provisions through the oversize/overweight permitting, administered by the Illinois DOT Permits Section.

*Roles and Responsibilities*

Enforcement of Illinois size and weight laws is performed by the Illinois State Police, Commercial Vehicle Enforcement Section. Oversize/overweight permitting is administered by the Illinois DOT Permits Section. In addition, Illinois has a system of state-maintained and locally-maintained designated truck routes, as well as a list of permit restricted roadways, due to dimensional limitations. An interactive mapping program provides information regarding

roadway class, state and locally-maintained truck routes, state and locally posted structures as well as overweight truck routes.<sup>43</sup>

### *Permit Process*

The Illinois DOT Permits Section issues oversize/overweight permits when infrastructure will not be unduly damaged and the safety of the traveling public will be adequately protected. Permits are also issued where substantial benefits will be realized by a large segment of the public and potential damage and safety problems can be resolved.

Illinois has a “Superload” permit program for very large loads. A permit is considered a Superload permit if any of the following is true:

- Width is greater than 14.5 feet;
- Length is greater than 145 feet;
- Height is greater than 15 feet;
- Any axle exceeds 25,000 pounds; and
- GVW is greater than 120,000 pounds.

Additional criteria for Superload permits can be found on IDOT’s web site<sup>44</sup> and include weights by axle groupings and configuration types. Superload permits require additional review by IDOT engineering staff.

Fees are generally modest. In Illinois, the cost of overweight permit fees vary by the distance traveled. For example, a single trip permit for a vehicle with six axles operating at up to 88,000 pounds is only \$10 for a distance of 45 miles or less, but increases to \$35 for distances of 451 to 495 miles. There is an on-line fee estimation web tool for Superload permits.<sup>45</sup>

### *Enforcement*

The Commercial Vehicle Enforcement Section of the Illinois State Police has 35 weigh stations operating in the State, by far the most of any state in the Upper Midwest.

---

<sup>43</sup>IDOT, *Getting Around Illinois* Trucking Information  
<http://www.gettingaroundillinois.com/default.aspx?ql=dtr>.

<sup>44</sup><http://www.dot.state.il.us/FAQ'sPermitOffice2008.htm>.

<sup>45</sup><https://permits.dot.state.il.us/permits/Estimatefee.aspx>.

## 2.7 INDIANA<sup>46</sup>

### Limits and Provisions

*Dimensions: Identical to Wisconsin on public roadways, larger dimensions allowed on Indiana Toll Road (ITR)*

Indiana limits height to 13.5 feet and width to 8.5 feet on public roadways.

Dimensions allowed on the Indiana Toll Road (ITR) without a permit are as follows: width of 12 feet, height of 14.5 feet, single vehicle length 65 feet, and a trailer length of 53 feet. Trailers in combination are limited to 28.5 feet with no overall combination length restriction. Oversize/overweight permits are required for dimensions exceeding these limits.

*Weight: Identical to Wisconsin on public roadways, heavier loads allowed on ITR*

Similar to Wisconsin, Indiana limits weights to 80,000 pounds in GVW, 20,000 for single axle weights, and 34,000 for tandem axles.

Vehicles operating on the ITR are limited to a maximum single axle weight of 22,400 pounds, a tandem axle weight per axle of 18,000 pounds (36,000 maximum), and a maximum GVW of 90,000 pounds. Permits are required for vehicles exceeding these weights.

### Exclusions and Exemptions

The following vehicles are exempt from standard Indiana truck size and weight laws when traveling on roadways other than Interstate highways:

- Vehicles engaged in the construction of highways, when the movement of the vehicle is confined to roadways or roadway segments that are not open to the public;
- Machinery or equipment used in highway construction or maintenance by the Indiana DOT or Indiana counties or municipalities;
- Implements of agriculture when used for farming operations or when constructed that the implements can be moved without material damage to highways;
- Farm vehicles loaded with a farm product, including unprocessed tobacco leaf (exempted from width or height restrictions);
- Fire-fighting apparatus owned or operated by a political subdivision or volunteer fire company; and
- Movements of a disabled vehicle or combination of vehicles for a distance of 50 miles or less by a registered recovery vehicle or vehicle.

---

<sup>46</sup>Indiana Size and Weight Laws are defined in (2008) Indiana Code 9 Article 20 (IC 9-20). Available at: <http://www.in.gov/legislative/ic/code/title9/ar20/>.

### *Roles and Responsibilities*

Size and weight law enforcement falls under the jurisdiction of the Indiana State Police, Commercial Vehicle Enforcement Division. Oversize/overweight permitting is administered by the Indiana Department of Revenue, Motor Carrier Services office.

### *Permit Process*

Oversize/overweight permitting is administered by the Indiana Department of Revenue, Motor Carrier Services office.

Indiana offers Superload permits for exceptionally large and/or heavy loads. Software packages including the Overload Routing System (O.R.S.) and the Bridge Analysis and Rating System (B.A.R.S.) are employed to find suitable routes and estimate impacts to infrastructure. INDOT defines a Superload as “any load that exceeds 15 feet high, 16 feet wide, 110 feet long, and/or 120,000 pounds, or fails the overload analysis.” Additional analysis by INDOT engineers is required for Superloads.

Michigan Train permits are available for select vehicle combinations but are restricted to operation in northern Indiana along designated routes. These permits allow a GVW of 134,000 pounds and single axle weight of 18,000 pounds in order to accommodate vehicles operating between Michigan (which has heavier allowable GVWs) and Indiana. These permits are primarily used for the hauling of steel loads.

Fees for oversize/overweight permits are \$30 for overdimension permits and a \$20 base fee plus a mileage-distance charge based on GVW, plus a \$25 design review fee for overweight permits. For GVW of less or equal to 108,000 pounds, the mileage charge is \$0.35 per mile. This charge goes up to \$1.00 per mile for GVWs of greater than 150,000 pounds. According to INDOT staff, approximately 7,500 permits for loads between 80k and 200k pounds are issued weekly, while roughly 75 permits are issued weekly for loads more than 200k pounds.

### *Enforcement*

The Indiana State Police’s Commercial Vehicle Enforcement Division utilizes 10 permanent scales along Indiana’s Interstate system to enforce truck size and weight regulations, weighing about 1.5 million commercial vehicles annually. Five of the 10 stations feature Weigh-in-Motion technologies.<sup>47</sup>

---

<sup>47</sup><http://www.in.gov/isp/2554.htm>.

## 2.8 MICHIGAN<sup>48</sup>

### Limits and Provisions

*Dimensions: Same as Wisconsin on designated highways, narrower widths, and shorter trailer lengths on all other roadways. Michigan allows LCVs on Interstate highways.*

Michigan limits commercial vehicles' width to 8.5 feet on designated highways and 8 feet on all other roads. Height is limited to 13.5 feet (same as Wisconsin). The length of a trailer including load is limited to 53 feet on Designated highways, 50 feet on Nondesignated highways. There is no limitation on overall length of combination vehicles.

Michigan allows LCVs on Interstate highways. Federal regulations allow LCVs with double trailer cargo carrying units up to 58 feet in total length on the Interstate system and Designated state highways. Federal law also allows for truck-trailer combinations carrying timber to operate on the National Network with a cargo carrying trailer up to 63 feet in length or 70 feet overall with power unit.

*Weight: Generally the same as Wisconsin, with the exception of heavier vehicle configurations due to axle-spacing. Single and tandem axle limits are the same as Wisconsin.*

Michigan limits 5-axle configurations to a GVW of 80,000 pounds on Interstate highways, but allows axle spacing variation for 5 and 6-axle vehicles to arrive at a GVW of up to 101,400 pounds (6-axle) on Interstate and other State highways, and 87,400 pounds (5-axle) on other State highways. An example 5-axle, 87,400 pound tractor-trailer-trailer configuration is shown in Figure 2.5 below, and a 6-axle 101,400 pound tractor-trailer configuration is provided in Figure 6.6. Michigan's limit on the total number of axles for a commercial vehicle is 11, which allows GVWs of up to 151,400.

Michigan enforces spring load restrictions, but milk haulers can apply for an exemption. Michigan restricts spring loads, but few highways are posted. There is no winter weight increase.

---

<sup>48</sup>Michigan Size and Weight Laws are defined in Michigan Vehicle Code Act 300 of 1949, Section 257.71x. Available at:  
[http://www.legislature.mi.gov/\(S\(mpjce5zd4yybub45docqs4zb\)\)/mileg.aspx?page=getobject&objectname=mcl-300-1949-VI-SIZE-WEIGHT-AND-LOAD&query=on&highlight=size%20AND%20weight](http://www.legislature.mi.gov/(S(mpjce5zd4yybub45docqs4zb))/mileg.aspx?page=getobject&objectname=mcl-300-1949-VI-SIZE-WEIGHT-AND-LOAD&query=on&highlight=size%20AND%20weight).

**Figure 2.7 Michigan Five-Axle, 87,400 Pound Combination**

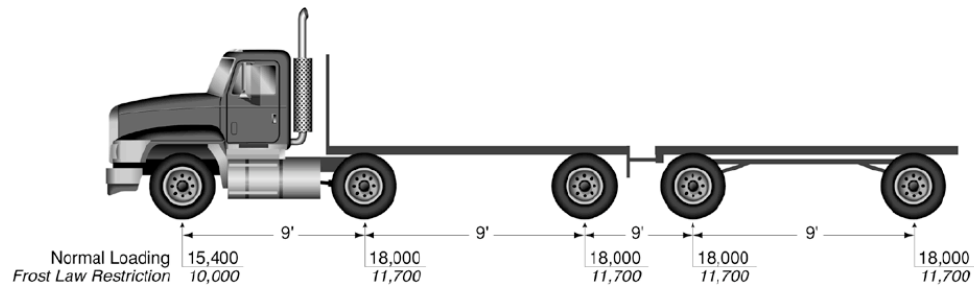

Source: Truck Drivers Guidebook, 11<sup>th</sup> edition, 2008.

**Figure 2.8 Michigan Six-Axle 101,400 Pound Combination**

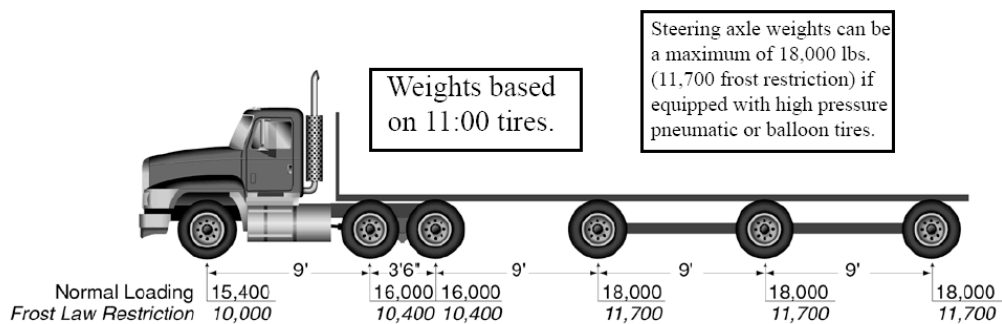

Source: Ibid.

### *Exclusions and Exemptions*

- 108-Inch Width Exceptions – Loads of unprocessed logs, pulpwood, wood bolts, agricultural products, and concrete pipe have a maximum width of 108 inches, 6 inches more than the normal legal width of 102 inches.
- Implements of Husbandry Width Exemption- Implements of husbandry, operated by a farmer only, can exceed the legal width limit to any width required for normal farming operations.
- Combination Length Exceptions – Truck and semitrailer or trailer, or two semitrailers in a combination can exceed the 53 feet length limit to 58 feet on Designated Highways and up to 59 feet on Nondesignated routes.
- 65-Foot Truck and Trailer or Semitrailer Length Exception – These combinations can be operated on Designated routes.
- 70-Foot Timber Hauler Length Exception – Timber haulers transporting saw logs, pulpwood, and tree length poles can move trailers or semitrailers up to 70 feet in length and may be operated on Designated routes, including National Network routes.
- Assembled Motor Vehicle Length Exceptions – Tractor and trailer or semitrailer combinations designed and used exclusively to move assembled



motor vehicles or bodies, recreational vehicles, or boats can exceed length limits to 65 feet except stinger-steered, single tow-bar, or saddle mount combinations, which can exceed length limits to 75 feet on Designated routes and 55 feet on Nondesignated routes.

The Michigan State Police Motor Carrier Division also produces a comprehensive Farmer's Transportation Guidebook in conjunction with the Michigan Farm Bureau which details all agriculture-specific roadway guidelines.<sup>49</sup>

### *Roles and Responsibilities*

Enforcement of Michigan size and weight laws is provided by the Michigan State Police, Traffic Safety Division, Commercial Vehicle Enforcement.<sup>50</sup> The Michigan DOT Oversize Permits office issues Oversize/Overweight permits.

### *Permit Process*

The Michigan DOT Oversize Permits office issues routine permits for nondivisible loads of up to 16 feet wide, 110 feet long, 15 feet high, and GVWs of 108,000 pounds for five-axle trucks and 120,000 pounds for six-axle trucks for certain configurations. Requests for permits that exceed these size and weight dimensions are handled through a Superload permitting process. Michigan offers MIPARS, an on-line web application which provides capabilities for permit type, load, weight, and routing evaluation and generation. MIPARS also includes mapping functions for restricted roadways.

Single trip permits are \$15 for overdimension permits (vehicle is legal in weight) and \$50 for any vehicles over legal axle weight limits.

### *Enforcement*

The Michigan State Police's Traffic Safety Division uses 21 state weight stations to identify commercial vehicles that may be in violation of size and weight regulations.<sup>51</sup> In addition, they deploy road patrol units, carrying portable scales to perform weight checks on commercial vehicles that may not cross state weigh station.

---

<sup>49</sup>Michigan Farmer's Transportation Guidebook,  
[http://www.michigan.gov/□documents/□msp/□Farm\\_Manual\\_2007\\_189909\\_7.pdf](http://www.michigan.gov/□documents/□msp/□Farm_Manual_2007_189909_7.pdf).

<sup>50</sup>Michigan State Police, Commercial Vehicle Enforcement:  
[http://www.michigan.gov/□msp/□0,1607,7-123-1593\\_47093\\_3536---,00.html](http://www.michigan.gov/□msp/□0,1607,7-123-1593_47093_3536---,00.html).

<sup>51</sup>Ibid.



## 3.0 Heavy Truck Equipment, Configuration, and Technology Trends

### 3.1 SUMMARY

The objective of this section is to identify the current manufacturing and industry trends in truck configurations and to focus on how these trends address the challenges affecting the truck size and weight laws and practices. Heavy truck equipment and technology trends to improve safety and mobility of the commercial vehicle industry are focused on addressing three major areas: infrastructure protection devices (pavement, bridges, and roadway design), safety enhancing technologies, and enforcement/compliance systems.

In order to complete this task, a review was conducted of international, national, and state practices that are currently available on the market or under research and development. Private manufacturers doing business in Wisconsin or with Wisconsin carriers were also interviewed to identify additional truck equipment, changes in configurations and technology trends.

The trucking industry has resisted the adoption of new technologies due to cost. There is a very low volume of new trucks manufactured compared to passenger vehicles: 150,000-250,000 per year versus 17 million new cars manufactured per year. Larger national fleets update more frequently and have a higher equipment turnover compared to smaller fleets that have less capital to upgrade. Market penetration is a slow process.

Small regional carriers are less likely to invest in and deploy innovative technologies. Carriers specializing in heavy hauling and regional/local hauling tend to maintain small fleets and replace equipment infrequently. Consequently, the demand for new vehicles and new technologies by smaller carriers is lower than for national carriers. Because small regional/local carriers are more likely to haul heavy commodities, such as raw agricultural or forest products, rapid deployment of innovations is unlikely within Wisconsin.

Benefits to pavement and bridge condition, safety, and compliance will not occur quickly for most technologies unless improvements to vehicles are mandated. Absent a regulation requiring adoption of these technologies, the applications that hold greatest promise for rapid deployment are those relatively inexpensive technologies, such as self-steering axles, that immediately begin to show a return on investment in the form of higher allowable weights.

## 3.2 HEAVY TRUCK EQUIPMENT AND TECHNOLOGY TRENDS

Heavy truck equipment and technology trends to improve safety and mobility of the commercial vehicle industry are focused on addressing three major areas: infrastructure protection devices (pavement, bridges, and roadway design), safety enhancing technologies, and enforcement/compliance systems.

### Infrastructure Protection Devices

Heavy trucks have a large impact on the system's infrastructure such as pavements and bridge structures. The following technologies are used to redistribute and adjust additional weight resulting from a heavy load:

- Smart Bridge applications;
- Dual tires versus wide-base single tires;
- Variable load axles and tires (lift axles);
- Automatic tire inflation;
- Self-steering axles;
- Smart suspension systems; and
- Weigh-in-Motion (WIM).

#### *Smart Bridge Applications*

A "Smart Bridge" is one that has sensors and instrumentation installed in the structure during or after construction to monitor its structural behavior and other performance under service loads and maximum loading conditions. See Table 3.1 for various smart bridge technologies.

**Table 3.1 Smart Bridge Technologies**

Instrumentation Currently In Use	Intended Usage
Cescor (Milan Italy) www.cescor.it	Monitoring corrosion reinforced and pre-stressed concrete structures
Force Technology www.force.dk/ciad	Monitoring of the corrosion condition of reinforcement
CorrPro Companies, Inc.	Measures the corrosion rate of steel reinforced concrete structures
Virginia Technologies, Inc. www.vatechnologies.com/eci/htm	Embeddable instrument capable of measuring parameters important to long term corrosion monitoring
Vetek Systems Corporation www.veteksystems.com	Monitoring for corrosion and corrosion rate
Geonor www.geonor.com	Embedded and surface mounted instrumentation for measuring strains, inclination and crack displacement
SOFO System www.smartec.ch	Monitoring strain in rebar or surface strain

Source: Parker, Neville A. and Ansari, Farhad. "Bridge Appurtenance" Final Report FHWA-NJ-2003-011. CUNY Institute for Transportation Systems, New York, New York, July 2003, <http://www.utrc2.org/research/assets/69/bridge1.pdf>.

### *Dual Tires versus Wide-Base Single Tires*

The use of both standard and wide-based tires has been considered. Recent increases in steering axle loadings and use of single tires on load-bearing axles have led to examine the effect on pavement deterioration of substituting single for dual tires. Past investigations of the pavement deterioration effects of single versus dual tires have found that single tires produce more pavement deterioration than dual, but that the differential wear effect diminishes with an increase in pavement stiffness, in the width of the single tire, and in tire load. A general finding is that wide-base single tires appear to cause about 1.5 times more rutting than dual tires on flexible pavements.<sup>52</sup>

### *Variable Load Axles and Tires (Lift Axles)*

Variable load (lift) axles and tires reduce pressure of the load on highway by increasing the surface contact area of the vehicle on the pavement when needed. When there is an empty load, the driver can lift the wheels off the surface.

### *Automatic Tire Inflation*

Automatic tire inflation (ATI) systems can monitor and adjust the tire pressure based on the load weight. ATI have sensors located in tires that consistently monitor the air pressure within the tire. Proper tire pressure can increase the tire life, reduce fuel consumption, and provide a consistent weight on all axles, which may reduce damage to the pavement.

### *Self-Steering Axles*

Self-steering axles can accommodate additional load weight and can stabilize loads on turns that may avoid rollovers. A self-steering axle is composed of at least two wheels that are fitted at each end with a device that can pivot around a vertical axis allowing the wheels to steer along the vehicle path. Smart suspension systems, such as air suspension or air ride suspension, automatically adjust suspension based on changing road conditions. Sensors detect road surface changes to the smart system, which then processes the information and adjusts the truck components to react properly. Proper suspension increases the load efficiency and decreases the damage to the pavement.

### *Weigh-in-motion (WIM) Technology*

There are five types of sensors used in Weigh-in-motion (WIM) technology. The first is the Kistler WIM, which is a series of Lineas® Quartz Sensors that provides very accurate vertical force readings in the pavement rather than the use of

---

<sup>52</sup>U.S. DOT Comprehensive Truck Size and Weight Study: Volume II Issues and Background. FHWA-PL-00-029, August 2000. <http://www.fhwa.dot.gov/reports/tswstudy/Vol2-Chapter6.pdf>.

detector loops.<sup>53</sup> The second WIM technology is the single load cell scale, which consists of two weighing platforms with a surface size of 6 feet by 3 feet, 2 inches, placed adjacent to each other to fully cover a normal 12-foot traffic lane and detect vehicle information. The third is a single hydraulic load cell, which is installed at the center of each platform to measure the force applied to the scales. The load measurements are recorded and analyzed by the system electronics to determine the axle loads. The fourth WIM sensor is the bending plate scale which consists of two steel platforms placed adjacent to each other to cover a 12-foot lane. The steel plate is instrumented with strain gages at critical points to measure the strain in the plate as a tire or axle passes over. The measured strain is analyzed to determine the axle load. The bending plate scale is typically installed in a lane with two inductive loops and an axle sensor to provide vehicle length and axle spacing information. Piezoelectric Sensors can also be used for WIM by measuring and analyzing the charge produced; the sensor can be used to measure the weight of a passing tire or axle group.

WIM technology for bridges, also known as Bridge WIM (B-WIM), consists of a series of sensors installed in pavement to detect the weight of the vehicle in advance of a bridge. If the truck is too large for the structure, the vehicle is alerted either by an in-vehicle warning system or a warning device along the road. Then the truck must find an alternate route.

## Safety Enhancing Technologies

Allowing the driver to safely operate the heavy truck is essential. Various technologies provide real-time vehicle operation and location information which can be used to monitor vehicle components and trip information. Driver information technologies consist of:

- Geo-Fencing;
- Automatic slack adjusters;
- Collision avoidance systems;
- Rollover warning systems;
- Side tracker video system; and
- Electronically controlled braking systems.

### *Geo-Fencing*

Geo-Fencing is a Global Positioning System (GPS) application that sets electronic boundaries for authorized and unauthorized routes for carriers depending on the size and weight of the load. This technology was initially used for security purposes in order to define a risk area and set a route around it. However, geo-

---

<sup>53</sup>Lineas® Quartz Sensors for Low and High Speed WIM. Kistler Organization. Seminar Centran presentation, June 2006. [http://www.centran.eb.br/plano\\_dir\\_pesagem/workshop/20062006/apresen\\_david\\_cornu.pdf](http://www.centran.eb.br/plano_dir_pesagem/workshop/20062006/apresen_david_cornu.pdf).

fencing can be useful for setting a route and alerting the driver if the route and its restrictions change.

### *Automatic Slack Adjusters*

Automatic slack adjusters (ASA) provide consistent truck braking performance and safety. The Federal government mandated the installation of ASAs on all commercial vehicles built after October 20, 1994. When properly maintained and adjusted, ASAs can reduce brake maintenance costs and provide optimal brake performance.

### *Collision Avoidance Systems*

Collision avoidance systems use radar-based sensors to detect potential hazards and provide automatic deceleration and limited braking. Freightliner Trucks, in conjunction with Meritor WABCO, started implementing the OnGuard™ Collision Safety System for select fleets. Developed by Meritor WABCO, OnGuard is a forward-looking, radar-based adaptive cruise control system with active braking for commercial vehicles.<sup>54</sup> Active braking improves vehicle safety by automatically using the vehicle foundation brakes to alert the driver and decelerate the vehicle when a pre-set vehicle following distance is compromised.

The system, introduced in early 2008, is designed to improve commercial vehicle safety. The OnGuard system applies the foundation brakes in adaptive cruise control mode. The system alerts the driver to a potentially dangerous situation through alarms and engine control. With adaptive cruise control activated, if the pre-determined “safe” distance is compromised, OnGuard will immediately provide visual and audible warnings to the driver; vehicle deceleration through engine control, and most important, foundation braking. Foundation brake deceleration can be greater than or up to one-third of a full brake application for the vehicle but within safe limits for the driver to take control.

OnGuard’s forward-looking, mono-pulse radar sensor is capable of detecting multiple moving objects at distances up to 500 feet away. It quickly coordinates responses from the engine, transmission, and antilock braking systems through communications across the data network. It provides feedback to the driver through the in-cab dash display, which includes a progressive audible alert.

### *Rollover Warning Systems*

Heavier trucks have a higher center of gravity and are therefore more prone to rollovers. As part of the U.S. DOT’s Intelligent Vehicle Initiative (IVI) Program, the department has worked with Freightliner Inc. on the development of technologies to detect and minimize the risk of vehicle rollovers. Rollover warning systems have been developed and implemented, such as the Rollover Stability Advisor, which warns drivers of the risk of a potential rollover, and the

---

<sup>54</sup>Freightliner Trucks and Meritor WABCO Offer Collision Safety System News Release. August 18, 2008. [www.freightlinertrucks.com/](http://www.freightlinertrucks.com/).

Rollover Stability Controller function automatically slows the vehicle. Both systems use sensors to detect and communicate with the truck's engine and brake system.

### *Sidetracker Video System*

The Sidetracker video system provides drivers with the visibility of their “no-Zone” or blind spot by installing a video camera on the right front fender mirror mount which views the entire right side of the tractor-trailer and adjacent lanes in turn increasing the safety of truck maneuverability.

### *Electronically Controlled Braking Systems*

Electronically controlled braking systems, as opposed to air brake systems, provide shorter braking distances, dynamic brake force distribution, and improved vehicle control, especially in curves, for reduced rollover chance. This technology uses electronic circuits and electro-pneumatic valves to perform this function, which in turn can improve antilock braking systems functionality by providing more specific control of wheel speed.

One example of modern electronically controlled braking systems has been developed by WABCO Holdings Inc., a leading provider of electronic braking, stability, suspension and transmission automation systems for heavy duty commercial vehicles. WABCO has developed a new telematics technology for trailer original equipment manufacturers and aftermarket.<sup>55</sup> WABCO's state-of-the-art telematics technology is intended to enable operating efficiency improvements, resulting in significant cost savings for fleet operators, freight agents, and logistics managers.

Suitable for all trailer types and tailored to meet the specific needs of each customer, the technology uses a high performance GPS receiver and quad band GSM modem. All antennas are integrated into the trailer telematics unit, which significantly simplifies installation.

The system provides continuous information such as location tracking and tracing, temperature, door status, tire pressure, load, and other technical data. It also integrates with existing WABCO systems such as electronic braking (Trailer EBS), suspension control, and integrated vehicle tire monitoring (IVTM). Fleet operators can access all of this information about their trailer from any location via an Internet portal. In the event of any critical situation, such as a cooling system malfunction, low tire pressure, or issues with the trailer braking system, WABCO's new trailer telematics system alerts the fleet operator who can take appropriate action such as sending an alarm via text message to the driver.

---

<sup>55</sup>WABCO Holdings, Inc., *WABCO Presents Trailer Telematics System for Improved Trailer Management at IAA Commercial Vehicles 2008*. News Release. September 9, 2008. [http://www.wabco-auto.com/press\\_releases/press-releases-wabco-presents-trailer-telematics-system-for-improved-trailer-management-at-iaa-commercial-vehicles-2008-new-telematics-technology-increases-operating-efficiency-for-transport-business](http://www.wabco-auto.com/press_releases/press-releases-wabco-presents-trailer-telematics-system-for-improved-trailer-management-at-iaa-commercial-vehicles-2008-new-telematics-technology-increases-operating-efficiency-for-transport-business).



WABCO's new trailer telematics system also enables optimized maintenance planning, safely keeping trailers on the road longer, and fleets equipped with it can potentially benefit from favorable insurance conditions due to increased theft prevention. Data processed by the system can be integrated into the customer's fleet management software and is supported by a helpdesk and global service network.

## **Enforcement/Compliance Systems**

There have been many advances in enforcement technologies to improve the accuracy and speed of commercial motor vehicle inspections. Devices used for enforcement and compliance include:

- Wireless Inspection via On-Board Scales;
- Automatic Vehicle Classification Systems and Bar Coding;
- Electronic seals (E-Seals) for cargo security; and
- Education/Enforcement Programs.

### *Wireless Inspection via On-Board Scales*

Technology is available to continually evaluate the condition of a heavy vehicle and monitor its cargo and weight. These systems are capable of tracking brake and tire conditions; the failure of exterior lighting mechanisms; steering, suspension, and exhaust system conditions; horn operation; and vehicle weight. The status of the truck in terms of these conditions can be extracted by law enforcement officers either by plugging a device directly in to the truck or by using wireless communication while the vehicle is traveling at highway speeds. The information can then be relayed to an officer via a wireless connection. This practice expedites weigh station stops and reduces associated resource costs. This device is also useful for random road inspections and wireless inspections. Although the accuracy is still questionable of some technologies this device assists the operator in determining whether or not the truck is the appropriate weight.

Another technology that is similar to the wireless inspection is virtual weigh stations. Using Weigh-In Motion (WIM) technologies along with photo imaging, sensors in the form of detector loops in the pavement detect vehicle weight while traveling by measuring tire forces and tire load. When a violation occurs, the system will automatically issue a ticket using a camera. This system increases efficiency by freeing up resources at highway weigh stations. As previously mentioned in the driver information technologies, geo-fencing can also be used to limit vehicles to a specific road network and can interact with an on-board scale informing law enforcement of a violator.

### *Automatic Vehicle Classification Systems and Bar Coding*

Automatic Vehicle Classification (AVC) Systems have been used by the private trucking industry for years for tracking containers, parking lot control and fee assessment. The potential use of AVC is for enforcement; it can be helpful in

keeping track of license plates and vehicle information. Bar coding has increasingly been used to collect vehicle data and track container information in the industry as well.

### *Electronic Seals (E-Seals) for Cargo Security*

An electronic seal (E-Seal) is a wireless technology that generates an alert to an official or dispatcher if a cargo seal has been broken. E-seals are most frequently employed to facilitate border crossing and customs clearance and are unlikely to be heavily adopted within Wisconsin.

### *Education/Enforcement Programs*

The Motor Carrier Safety Assistance Program (MCSAP) has developed a large truck and bus safety program plan to monitor commercial motor vehicle traffic by increasing enforcement in order to reduce both the number and severity of truck-involved crashes.<sup>56</sup> The MCSAP is a national grant program, which 80 percent of the program funds are provided through the Federal Motor Carrier Safety Administration (FMCSA) and the remaining 20 percent provided from the State. The program involves large truck driver/vehicle inspections and investigations as well as education of the public and industry and other enforcement components.

The goal of the enforcement component of the MCSAP program in Wisconsin is to do the following:

- Conduct 37,500 MCSAP inspections.
- Perform 300 compliance reviews and 1,000 new entrant audits.
- Increase by 20 percent the number of mobile MCSAP inspections (with traffic enforcement when warranted) in counties where there are a higher than average number of truck crashes. The counties are Brown, Columbia, Dane, Dodge, Dunn, Eau Claire, Fond du Lac, Jefferson, Juneau, Kenosha, Marathon, Milwaukee, Outagamie, Racine, Rock, Sauk, St. Croix, Walworth, Washington, Waukesha, and Winnebago.
- Conduct two thirds of inspections as a mobile with traffic enforcement when warranted. Mobile inspections shall be done on rural roads or bypass routes; in high crash areas, or other areas directed by data or experience. All mobile inspections shall include a traffic enforcement component when applicable.
- Enforce laws related to drug trafficking, possession, and use through MCSAP canine activities.

The MCSAP program will also educate the public and industry by:

---

<sup>56</sup>State of Wisconsin Federal Fiscal Year 2008 Highway Safety Performance Plan: Large Truck and Bus Safety Program Plan. <http://www.dot.wisconsin.gov/library/publications/topic/safety/hwysafetyp lan-truck.pdf>.

- Providing outreach to local agencies on the proper completion of the crash report;
- Providing educational opportunities to the public and industry through media campaigns, handouts, posters, presentations, conferences, and other outreach;
- Making education a part of every enforcement stop;
- Partnering with the safety community, at large, to educate others on commercial motor vehicles issues;
- Providing classroom training and manuals to state patrol staff as needed;
- Educating the judiciary by providing expert testimony in court cases; and
- Educating new motor carriers through the New Entrant Program.

By enforcing truck size and weight laws and educating the public and industry through effective use of Federal and state Highway Safety funds and other resources through the MSCAP, WisDOT is one step closer to achieving their “zero vision” goal of seeing all motor vehicles size and weight compliant.

### **3.3 TRENDS OF ORIGINAL EQUIPMENT MANUFACTURERS**

Interviews with original equipment manufacturers (OEMs) were conducted to determine industry trends in vehicle design and technologies, including areas of emphasis in product development. Interviews began by informing the company contact, generally a design or marketing individual, about the WisDOT study’s investigation of the feasibility of maximizing load capacities and driver safety while operating on the highway system and asking for specific examples of the general direction of their company within the industry. Questions focused on vehicle design and technologies for moving larger loads while maintaining driver safety; innovations within the company; interest or intent to change truck size configurations; and currently applied new technologies for use by the driver and the company. Interview findings were supplemented with Internet searches for heavy truck OEM industry news and trends.

This process produced the following findings:

- Currently, the primary focus of many OEMs is on fuel efficiency and fuel economy systems. For example, OEMs are offering hybrid technologies which boosts savings of up to 1,500 gallons of fuel per year in a typical urban delivery, including emissions benefits and an extension of the life of the brakes and engine. Battery powered cooling systems that directly achieve idle reduction time by regulating the internal cab temperature for up to 10 hours can further boost fuel efficiency and reduce emissions.
- Steel corrosion prevention is also an equipment priority due to the de-icing chemicals now used on Wisconsin highways.

- Several new tractors are designed to haul heavier loads. In many cases, trailers are already capable of handling heavier loads within Wisconsin's TSW laws, some through adding an axle, and some, like grain trailers, are operating just when weight restrictions are lifted on state highways during harvest season. Trailers are able to handle heavier loads now and with technology available to offset stopping distances, such as disc brakes or additional axles, trucks would not be bigger necessarily, just heavier.
- In general, only rollover stability and antilock brakes are standard technologies. Driver alert systems, such as electrical wiring systems to the wheels and tires can send driver alerts for safety issues. Right now technology is not standard, but OEMs are seeing increased demand for and adoption of such innovations.
- Driver safety features are generally considered add-ons. Blind-spot cameras and tire-pressure monitoring systems, are typically available as an add-on to commercial motor vehicles. Other available safety enhancement add-ons include electronically controlled braking systems capable of detecting moving objects up to 500 feet away providing visual and audio feedback to the driver. These are currently being installed in trucks, but are not standard.

### 3.4 CONCLUSIONS

Heavy truck equipment and technology trends such as safety enhancing technologies, infrastructure protection devices for pavement, bridges and roadways, and enforcement and compliance systems are areas that will improve safety and mobility of the commercial vehicle industry.

Smart bridge applications, dual tires versus wide-base single tires, variable load axles and tires (lift axles), automatic tire inflation, self-steering axles, smart suspension systems, and weigh-in-motion (WIM) are some technologies that can be used to redistribute and adjust additional weight resulting from a heavy load.

Safety enhancing technologies and driver information technologies such as geo-fencing (Global Positioning), automatic slack adjusters (ASA), collision avoidance systems, rollover warning systems, side tracker video system, and electronically controlled braking systems allow the driver to safely operate the heavy truck and can provide real-time vehicle operation and location information.

There have been many advances in enforcement technologies to improve the accuracy and speed of commercial motor vehicle inspections. Devices used for enforcement/compliance includes wireless inspection via on-board scales, virtual weigh stations, geo-fencing, AVI and automatic vehicle classification (AVC) systems and bar coding, and electronic seals (E-Seals) for cargo security.

Although new technologies and equipment are being introduced to the industry every year there are some limitations. Typically market penetration is a slow process, since small regional carriers are less likely to invest in and deploy innovative technologies. Benefits to pavement and bridge condition, safety, and

compliance will not occur quickly for most technologies unless improvements to vehicles are mandated. Absent a regulation requiring adoption of these technologies, the applications that hold greatest promise for rapid deployment are those relatively inexpensive technologies, such as self-steering axles, that immediately begin to show a return on investment in the form of higher allowable weights. The primary focus of equipment manufacturers is currently on fuel efficiency and fuel economy systems.

It may be prudent for states to require the use of new technologies as a condition for allowing special higher weight and size permits. By enforcing truck size and weight laws and educating the public and industry through effective use of Federal and state Highway Safety funds and other resources through the Motor Carrier Safety Assistance Program, WisDOT can promote safety and efficiency for commercial vehicles operating within the State.



## 4.0 Review of Changing Business Practices and Economic Forces

This section's purpose is to provide insight into the economic forces, particularly those in Wisconsin, that are driving industry demand for modifications in truck size and weight restrictions. This analysis focuses on how current and future trends are affecting the trucking, shipping, and logistics industries and their relevance to truck size and weight laws.

### 4.1 METHODOLOGY

The chapter draws upon several sources of freight industry trends and data, including 2001 TRANSEARCH Data belonging to WisDOT, the 2002 Commodity Flow Survey, 2002 Economic Census, and 2006 Wisconsin Agricultural Statistics to identify the major trends influencing current truck size and weight discussions. Conversations with officials in the Division of Transportation Investment Management within WisDOT and with representatives from several key Wisconsin industry groups have provided valuable information on the geographic characteristics, routing, and emerging trends for industries involving or generating high-tonnage commodities. Some information for this chapter was collected at workshops held in Waukesha, Wausau, and Madison. These workshops were held to gain better insight into the economic benefits that the State of Wisconsin could receive from modifying its truck size and weight regulations.

The WisDOT Division of Transportation Investment Management Bureau of Planning is completing work on a study analyzing overall economic impacts of freight movements by truck in the state. Their work will also influence the final version of this memorandum.

The information collected responds to the following core questions:

- How is the current Wisconsin freight network performing and what is the future demand?
- What are the current macroeconomic and Wisconsin-specific trends affecting the state's industries involved in goods movement?
- How are Wisconsin's businesses reacting to the macroeconomic challenges and opportunities of moving freight in Wisconsin? What influence would size and weight modifications have on their businesses?
- Which industries and product groups are most likely to be impacted by changes in truck size and weight regulations? What are the geographic characteristics of these industries?

- What industries would be the most influenced by changes to Wisconsin’s size and weight restrictions? How are these industries likely to influence the infrastructure network in the state?

## 4.2 SYSTEM PERFORMANCE

Wisconsin’s transportation network consists of over 113,000 miles of roadways, with the state trunk system and county trunk highway system including 11,812 and 19,824 miles, respectively. Town roads include over one-half of the total roadway network at 61,910 miles. In 2004, approximately 3,400 miles of rail lines operated in the State. Canadian National is the largest freight rail operator in the State.

Wisconsin’s freight transportation system moves over \$300 billion in goods and is critical for linking local, national, and international consumers and producers. Freight demand has grown significantly over the last few decades and freight is projected to further increase another 70 percent by 2025. While this level of growth is slightly lower than in other areas of the country, the projected increased usage of the state’s freight system will present significant challenges for policy makers in an era of economic downturns, reduced revenues, increasing construction costs, and possible recessions. As state budgets are further constrained, the ability to expand the infrastructure systems becomes more difficult financially. Consequently, all modes of freight transportation are being challenged to increase capacity and improve productivity to respond to this growth. Ultimately, efficient movement of freight will provide economic growth in the form of job creation and tax base escalation.

Table 4.1 below, from the 2002 Commodity Flow Survey (CFS), indicates that a majority of Wisconsin truck tonnage (53.6 percent) travels less than 50 miles. On a per unit basis, the value of these short shipments is lower than commodities moving longer distances. The table also shows that goods traveling over 500 miles constitute the least amount of tonnage, but are of the most per unit value and total share of the value. In summary, short-haul freight has a much higher tonnage-to-value ratio than long haul shipments.

**Table 4.1 Truck Haul Lengths Originating in Wisconsin by Value and Tonnage**

Distance in Miles	Share of Tonnage	Share of Value
Less than 50	53.6	25.3
50-99	11.5	13.8
100-249	14.2	19.2
250-500	10.5	15.8
Over 500	10.3	25.8

Source: 2002 Commodity Flow Survey.



Of the four freight modes (rail, water, truck, and air), the trucking industry is growing at the highest rate nationally and in Wisconsin. Exact percentages differ depending on the source data, but it is expected that the trucking-related share of freight movements will continue to increase. According to the 2002 CFS survey, 74 percent of total Wisconsin freight tonnage is by truck. Global Insight TRANSEARCH data for 2001 showed a 72 percent mode share. Truck ton-miles represent just under one-half of the total ton-miles of goods movements with an average truck trip length of 183 miles. As expected, other modes have significantly longer average trip lengths within, exported from, and imported to Wisconsin. Table 4.2 highlights the average miles per mode, as well as the ton-miles per road.

**Table 4.2 Shipment Characteristics by Total Modal Activity for State of Origin**  
2002

Mode of Transportation	Ton-Miles	Percent	Average Miles Per Shipment
Total	70,753	100.0	642
Truck	34,949	49.4	183
Rail	22,347	31.6	787
Air	65	–	1,243
Other Modes and Unknown	1,641	2.3	Unknown

Source: 2002 Commodity Flow Survey.

The majority of Wisconsin shipments tend to stay within Wisconsin and surrounding states, although Wisconsin products compete in the global marketplace as well. Canada is the primary international destination for Wisconsin products, including paper, dairy products, and heavy machinery. Exports to significant international trading partners is outlined in Table 4.3 below.

**Table 4.3 Wisconsin's Top 5 International Export Markets**  
2007

Country	2007 Total Exports (\$)	Export Growth 2006-2007
Canada	5.8 billion	+7.3%
Mexico	1.9 billion	+2%
China	1.2 billion	+35.4%
United Kingdom	722.8 million	+6.0%
Germany	660.8 million	+13.4%

Source: Wisconsin Department of Commerce.

## 4.3 TRENDS IMPACTING FREIGHT MOVEMENTS

Several key trends have been identified that significantly impact commercial trucking in Wisconsin and nationally, which are discussed in greater detail below.

### Diesel Fuel Prices

The cost of diesel fuel had more than tripled in the Midwest by late summer 2008. The U.S. average retail price in January 2002 was \$1.15 per gallon, which is comparable to the price of diesel fuel in the Midwest during that time period. By September 2008, the price had risen to \$3.93 per gallon in the Midwest, after peaking at over \$4.75 per gallon in the summer of 2008, as shown in Figure 4.1 below. This causes pressure to consider reducing the numbers of loads carried, even at reduced fuel efficiencies. The price of diesel fuel has risen much faster than the rate of overall inflation, which has averaged between 2 and 3 percent a year from 2002 to 2007. Nationally, these prices have forced many small trucking firms out of business. The firms that have gone out of business equates to 88,000 trucks (4.5 percent of national industry capacity) taken off the road.

In 2008, for the first time in history, fuel costs have surpassed labor costs to become the number one cost for most trucking companies. Increasing diesel prices have caused state-based carriers to reevaluate the need to combine and increase load sizes. A state-based national truckload carrier estimates that as much as \$50 billion in shipper savings would be gained by increased use of longer, heavier trucks.

**Figure 4.1 Average Weekly Midwest Diesel Retail Sales**  
September 1994 to September 2008



Source: Energy Information Administration.

## **Transportation Infrastructure Capacity Constraints**

Across the United States and in Wisconsin, growth in transportation system capacity has not kept pace with the growth of population and production. The population in the state of Wisconsin increased 3.6 percent from April 2000 through 2006. Most of this population growth is in metropolitan areas, such as Madison, the Fox Cities, La Crosse, Eau Claire, and Green Bay. Population in Milwaukee proper continues to decrease, although it is offset by significant growth of the surrounding suburbs, which is increasing congestion and impeding freight movement.

The population growth and changes in driving behavior prevent the infrastructure in place from fully accommodating future freight demand without significant capital investments or changes in transportation operations. Expansion of highways is difficult in a climate of constrained and contracting budgets.

Attempts to shift freight from highway to other modes, including rail and barge, have limited potential to mitigate congestion in the long term, in part because these modes are encountering their own capacity-limiting challenges. The global demand for U.S. corn, wheat and soybeans is limited by inefficiencies in the country's railways, highways and river barge systems that carry grain and other commodities to export markets. Barge delays alone added an average of \$72.6 million annually to the cost of shipping goods down the Mississippi and Illinois rivers, according to a new Army Corps of Engineers analysis of 2007 conditions. These bottlenecks cost farmers, shippers, and ultimately consumers millions of dollars a year. Much of the barge delay is a result of undersized locks on the Mississippi River.

Railroads in the United States and in Wisconsin currently are running at full or nearly full capacity. The National Rail Freight Infrastructure Capacity and Investment Study, commissioned by the American Association of Railroads, identified over \$148 billion in capital investment needs to meet projected rail freight demand. Many long haul corridors are reducing stops to maximize efficiencies, causing long drayage routes to take shape. In Wisconsin, there are a significant number of truck trips generated by backhaul freight.

Given this capacity constraint in both the inland waterway system and the freight rail network, increasing volumes of freight will travel on Wisconsin's highways and local road system. Highway capacity constraints will cause shippers, producers, carriers, and consumers to be increasingly impacted by congestion on the highway system. Given these trends, transportation system expansion and increased productivity will continue to emerge as policy discussion items within the transportation sector.

## **Industry-Specific Trends**

Several industry specific trends are going to have significant impacts on the movement of freight by truck in Wisconsin. Agricultural trends, hydrofracking, and ethanol production trends are discussed here.

### *Agricultural Trends*

The state's agricultural exports have nearly doubled in value in the past three years, up from \$1.1 billion in 2004 – nearly a 100 percent increase. Dairy exports increased 131 percent, up from \$84.7 million in 2006 to \$195.8 million in 2007, driven by demand for cheese, whey, and butter.

Changes in agricultural production generally in the United States also have altered the delivery of farm products from field to market or processing. Consolidation of many small farms into fewer larger farms and cooperative ventures means that farmers and farming corporations can achieve transportation economies of scale by shipping their own products with their own equipment.

Consequently, farms are shipping more outputs over longer distances compared to the previous pattern where farmers would focus on short moves to local consolidation points and rail terminals. As a result, grain producers have begun to rely less on railroads to ship their grain products, instead turning to farmer-owned semitrailers for product delivery.

The use of trucks provides grain producers increased mobility options because they now have the ability to bypass local grain elevators and railroads and haul directly, albeit over a longer distance, to the processor, to another railroad, or to the Mississippi River for water transport.

### *Hydrofracking*

Hydrofracking is a process gaining widespread use in the oil and gas industries. In this process, tons of sand mixed with millions of gallons of water are forced underground at high pressure to break up rock. Fracturing has been widely used since the 1970s to increase production from formations with low permeability or wellbore damage. However, recent improvements and testing demonstrate that unlike conventional hydraulic and acid fracturing techniques, a mixture of carbon dioxide and sand stimulates the flow of oils and natural gasses without the risk of formation damage and without producing potentially toxic wastes for disposal.

In this process, a mixture of sand and liquid CO<sub>2</sub> is forced into the formation, where it creates and enlarges fractures. The CO<sub>2</sub> vaporizes, leaving only the sand to hold the fracture open – no liquids, gels, or chemicals are used that could create waste or damage the reservoir. As a result of this new process, combined with the high demand for oil and gas, demand for sand has increased significantly.

The high demand and the increased shipping distances for sand is a relatively new phenomenon. Based on the 2002 CFS, the average distance that natural sands were shipped was only 32 miles per trip. As a result of fracking's popularity, Wisconsin sands are shipped to many of the same places where oil and natural gasses are extracted. Fracking has also resulted in some value-added services in the state of Wisconsin, as sand mined in the central part of the state

has been shipped to the Fox River Valley area to be combined with other materials to improve the fracturing qualities.

### *Ethanol Production*

Ethanol is a liquid fuel that is produced by the fermentation of plant sugars. In Wisconsin, ethanol is primarily produced from corn. Currently, one bushel of field corn will yield approximately 2.7 gallons of fuel ethanol.

According to the Wisconsin Office of Energy Independence, the first large scale ethanol facility began producing in 2001, which is the first year that Wisconsin began producing ethanol. Wisconsin's annual ethanol production capacity has reached 470 million gallons, making it the ninth-largest in the country in terms of ethanol production capacity. Ethanol production in Wisconsin increased from 210.4 million gallons in 2006 to 283.8 million gallons in 2007, an increase of over 34 percent. Wisconsin is home to eight operating ethanol plants, with several more planned or proposed.

A Jefferson production facility, one of the largest ethanol plants in the State, grinds up to 150 truckloads of corn per day to produce about 3 million gallons of ethanol per week. Dried distillers grains are a relatively new export, and increased 245 percent, up from \$6 million in 2006 to \$19.2 million in 2007, driven by strong demand in Asia. A by-product of the state's burgeoning ethanol industry, distillers grains are sought as a high-protein livestock feed.

### **Changes in Production Locations**

Proximity-based sourcing has begun to influence decisions on the location of production facilities. The rising cost of shipping is forcing some manufacturers to bring production back to North America and stop plans to further outsource production. This trend affects many products, such as industrial-pump parts, lawnmower batteries, and living room sofas. Many distribution centers have been required to shorten their shipping radii, in an attempt to reduce travel time and fuel consumption. Conventional wisdom now indicates that 500 miles in a chain retail distribution environment is recommended, down from 700 miles two years ago.

Figure 4.2 shows the various distribution centers in the State of Wisconsin across multiple industry sectors.

Figure 4.2 Wisconsin's Distribution Centers by Location<sup>57</sup>

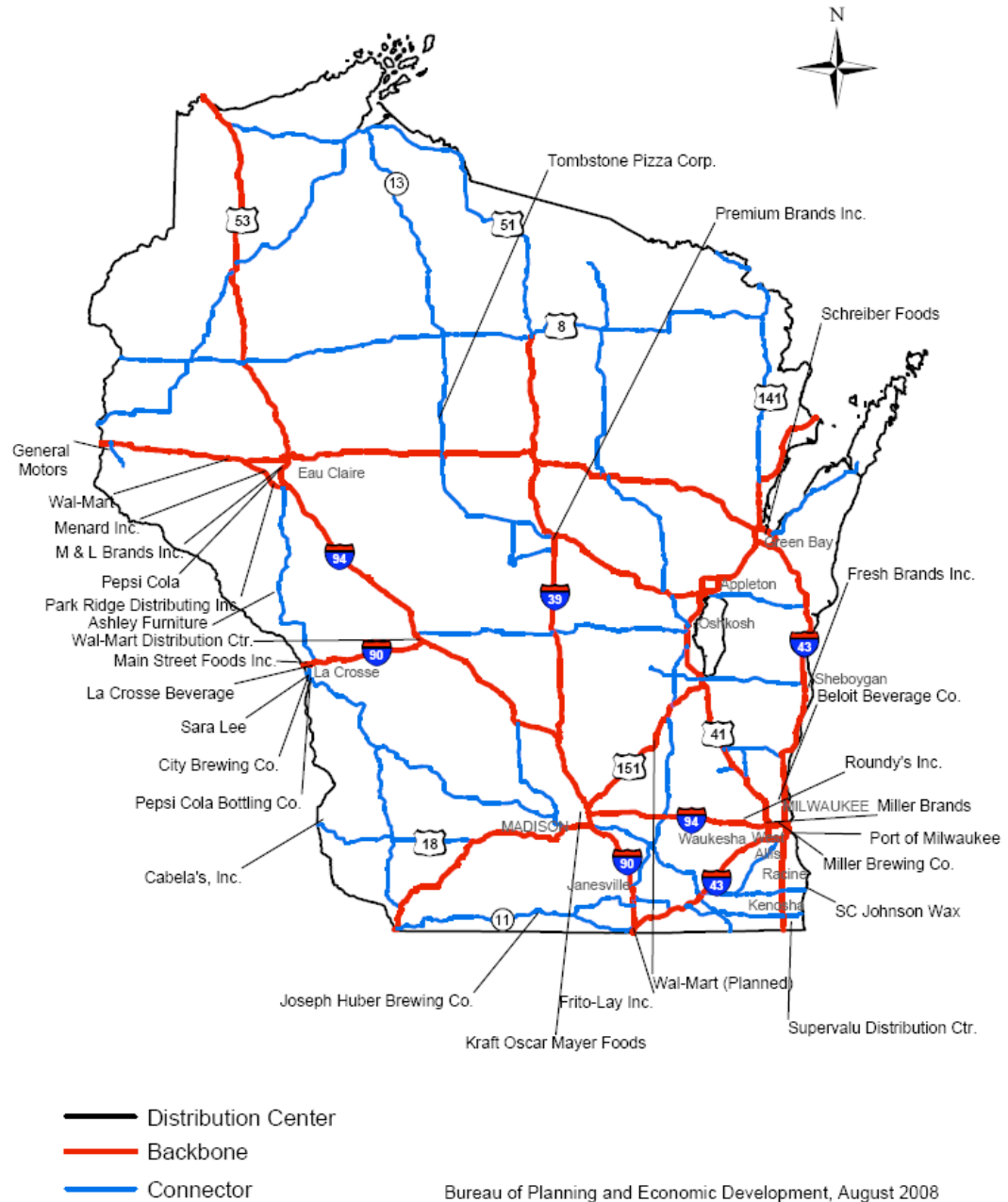

<sup>57</sup>This Figure was compiled in 2007 by WisDOT's Bureau of Traffic Forecasting. While it is not exhaustive, it does capture the major warehouses and distribution centers in the State.

The distribution centers shown above also create much secondary traffic in the state. The freight movements between facilities comprising the secondary traffic categorization in Wisconsin were 12.68 percent of all tonnage in 2001, totaling over 63 million tons.

### **Railroad Operating Practices**

Railroad disruptions, including the abandonment of short haul services, equipment shortages and lack of availability of railcars, can impact distances of heavy hauling, especially if agricultural and/or other loads must be diverted to trucks to access alternative rail terminals. Increasing drayage distances from abandoned short-line rails have been shown to have pavement impacts.

Of particular concern for rail operations in the Midwest is the congestion of the rail hubs in Chicago. Wisconsin and the rest of the upper Midwest are largely dependent on Chicago for efficient intermodal routing. With mounting capacity constraints and no immediate plans for resolution, Chicago disruptions are creating a higher demand for railheads outside of the Chicago region, which could impact freight transportation demand in the region.

### **New Ports of Entry**

The opening of a new international container port in western Canada, which significantly reduces the ocean time between North America and the Far East, has impacts on Wisconsin. Canadian National (CN) railroad opened a container port at Prince Rupert, British Columbia, Canada in 2007, from where CN is providing 105-hour rail-freight service to Chicago. Some of this freight is then shipped by truck from Chicago back to Minneapolis, which results in an increased number of containerized shipments traveling through Wisconsin. It is likely that these movements will remain confined to the Interstate 90/94 corridors, which are generally regulated by Federal size and weight limitations.

### **Trucking Workforce Issues**

According to the chief economist for the American Trucking Association, the transportation industry in the United States is facing prolonged labor shortages, especially for long-haul truck drivers. One of the nation's largest trucking companies has taken an aggressive approach to recruiting new long-haul drivers, even engaging with the U.S. Army Reserve to give reservists a chance for employment after they complete military occupational training.

The trucking industry, despite the 2008 economic slowdown, still expects a shortage of 185,000 drivers by 2010. Truck driver turnover, however, is experiencing a positive trend. In the second quarter of 2008, turnover was projected at 85 percent, while the peak turnover rate was 136 percent in late 2004 and 2005.

## Shortage in Freight Equipment

National demand for truckload carriers is increasing because of two primary reasons. First, in 2007, there was a 2.6 percent decrease in the available truckload fleet and in the first one-half of 2008, an additional 1.3 percent decrease in the fleet was noted. In the Upper Midwest region, there was a 2.0 percent decrease in 2007 and 1.1 percent decrease in the first one-half of 2008 in the available truckload fleet. The American Trucking Association also reports that an increasing number of trucking company failures has been noted in the first two quarters of 2008, with nearly 2000 trucking firms going out of business.

Demand for rail cars and ocean freighters has outpaced supply, resulting in rate increases for rail shipments and waterborne shipments. Consequently, many international and long-haul rates for heavy commodities are increasing.

## 4.4 OVERVIEW OF WISCONSIN COMMODITIES

A wide variety of locally produced and imported commodities are transported throughout Wisconsin. Table 4.4 below presents an overview, based on the 2001 TRANSEARCH database, of the commodities that transported in the state. Secondary traffic, which is defined freight flows to and from distribution centers or through intermodal facilities, represents a large percentage of the overall tonnage. Nonmetallic minerals top the list of transported tonnage in the state, with farm products and secondary traffic a distant second and third, respectively. Many of Wisconsin's best known products, including paper, lumber, and farm products, are also included in this list.

**Table 4.4 2001 Wisconsin Commodity Transport by Tonnage (All Modes)**

Commodity	Tons	Percent of Total
Nonmetallic Minerals	179,070,049	25.0%
Farm Products	71,777,464	10.0%
Secondary Traffic (Warehouse and Drayage)	63,009,748	8.8%
Metallic Ores	58,756,523	8.2%
Coal	57,655,543	8.0%
Food Or Kindred Products	54,026,247	7.5%
Clay, Concrete, Glass Or Stone	44,269,023	6.2%
Lumber Or Wood Products	43,255,796	6.0%
Chemicals Or Allied Products	33,080,577	4.6%
Pulp, Paper Or Allied Products	28,782,396	4.0%
All Other	83,955,758	11.7%
<b>Total</b>	<b>717,639,124</b>	<b>100.0%</b>

Source: TRANSEARCH (Global Insight), formerly Reebie and Associates, 2001.



Table 4.5 below presents an overview of the commodity transport by *truck* only. When compared with Table 4.4, it becomes apparent that secondary traffic is second in commodities moved by truck, since all secondary traffic is truck traffic. It is also evident that metallic ores and coal are not near the top of the truck list, as a greater share of these goods is moved by other modes in Wisconsin.

**Table 4.5 2001 Top Wisconsin Commodities (Truck Only)**

NAICS	Tonnage (2001)	Industry
14	166,568,829	Nonmetallic Minerals
50	63,009,748	Secondary Traffic
1	51,234,099	Farm Products
20	42,892,972	Food or Kindred Products
32	37,329,349	Clay, Concrete, Glass or Stone Products
24	32,926,030	Lumber or Wood Products
28	17,717,048	Chemicals
26	17,535,422	Pulp, Paper or Allied Products
29	16,229,898	Petroleum or Coal Products
33	13,063,852	Primary Metal Products
34	9,775,475	Fabricated Metal Products
37	6,845,262	Transportation Equipment
35	4,615,606	Machinery – Other Than Electrical

Source: TRANSEARCH (Global Insight), formerly Reebie and Associates, 2001.

Table 4.6 presents an overview of the top 5 commodity groups that travel within the state, are exported from the state, and are imported to the state. Sand and gravel (a subgroup of the “nonmetallic minerals” category mentioned in the tables above) are the top commodities that travel within the state, while coal and petroleum products are in the top 5 for all three categories. Cereal grains, aside from being the state’s top export by truck, are also a top import and a top 5 good moved within the State.

**Table 4.6 Wisconsin's Top Commodities by Tonnage; Within, Export, and Import**

<b>Tons (Millions) Within State (By Truck)</b>	
Sand and Gravel	45.7
Cereal grains (Oats, Wheat, and others)	30.2
Nonmetal mineral products	20.1
Waste/scrap	16.8
Coal and Petroleum products	10.9
<b>Total</b>	<b>214.6</b>
Cereal grains (Oats, Wheat, and others)	21.3
Coal, not elsewhere classified	16.4
Gravel	15.0
Other foodstuffs	11.9
<b>Tons (Millions) Within State (By Truck)</b>	
Fertilizers	4.8
<b>Total</b>	<b>134.2</b>
Coal	34.9
Coal and Petroleum, not elsewhere classified	29.0
Nonmetallic mineral products	11.8
Cereal grains	9.9
Base metals	6.5
<b>Total</b>	<b>179.8</b>

Source: Federal Highway Administration, 2002.

The manufacturing sector spans many industries and regions in Wisconsin, thus it is necessary to give a general overview of the transport of commodities in this sector.

Employment in Wisconsin's manufacturing sector, as a percentage of total employment, is higher than the national average, due in part to a slower-than-average rate of decrease in manufacturing jobs over the last decade. Wisconsin also derives a rather large share of its Gross State Product (GSP) from manufacturing, when compared to the nation as a whole. Jobs in this sector account for about one-sixth of all jobs in the state. Adjusted for inflation, manufacturing output in Wisconsin rose by more than 75 percent in the 15 years from 1986 to 2000, even as manufacturing employment fell. The largest manufacturing industries in the state, as measured by output, are 1) machinery, notably the production of engines, turbines, and power transmission equipment; 2) transportation equipment, especially the auto industry; and 3) food, led by dairy products. The State enjoys notable specialization in 1) paper production; 2) electrical equipment, appliance, and component manufacturing; 3) leather and allied products (including footwear); 4) machinery; and 5) wood products.

Wisconsin leads the nation in the production of low-horsepower gasoline engines, power cranes, shovel hoists, industrial controls, x-ray equipment, mining machinery, and other types of industrial equipment. The State's top manufacturing exports are highlighted below Table 4.7.

**Table 4.7 Wisconsin's Top Manufacturing Export Commodities by Value**

<b>Mfg Commodity</b>	<b>2007 Total Trade (\$)</b>	<b>Growth 2006-2007</b>
Industrial Machinery	5.8 billion	+11.8%
Electrical Machinery	1.9 billion	+5.7%
Medical/Scientific Instruments	1.2 billion	- 0.1%
Agricultural Products	722.8 million	+45.1%
Transportation Equipment	660.8 million	+18.4%

Source: Wisconsin Department of Commerce.

## 4.5 GEOGRAPHIC DISTRIBUTION OF FREIGHT GENERATION

From Tables 4.8 and 4.9 below, it is evident that eastern Wisconsin generates and receives the largest amount of freight. This is to be expected, since a disproportionately large number of the population live and work in Milwaukee, the Fox River Valley, or Dane County. Milwaukee County, specifically, is both the top county for originating and terminating truck tonnage in the state. Particularly telling is the fact that counties with high populations, such as Milwaukee, Outagamie and Dane, are near or at the top of the terminating truck tonnage table.

**Table 4.8 Top 10 Wisconsin Counties – Originating Truck Tonnage  
2001**

County	2001 Tons	Percent of Wisconsin Originating Tonnage
Milwaukee	25,533,962	7.13%
Outagamie	24,117,590	6.73%
Jackson	18,762,502	5.24%
Winnebago	17,551,947	4.90%
Waukesha	17,083,239	4.77%
Waupaca	12,594,412	3.52%
Sheboygan	11,557,213	3.23%
Dane	11,526,316	3.22%
Waushara	11,356,750	3.17%
Racine	11,082,422	3.09%
Other	196,959,541	55.00%
<b>Total</b>	<b>358,125,894</b>	<b>100.00%</b>

Source: TRANSEARCH (Global Insight), formerly Reebie & Associates, 2001.

**Table 4.9 Top 10 Wisconsin Counties – Terminating Truck Tonnage  
2001**

County	2001 Tons	Percent
Milwaukee	54,433,721	16.23%
Outagamie	32,251,225	9.61%
Dane	27,840,511	8.30%
Winnebago	23,400,546	6.98%
Brown	17,874,883	5.33%
Waukesha	17,730,862	5.29%
Marathon	10,156,920	3.03%
La Crosse	8,946,181	2.67%
Wood	8,406,987	2.51%
Rock	7,576,684	2.26%
Other	126,825,160	37.81%
<b>Total</b>	<b>335,443,680</b>	<b>100.00%</b>

Source: TRANSEARCH (Global Insight), formerly Reebie & Associates, 2001.

## 4.6 BUSINESS PRACTICES AND GEOGRAPHIC CHARACTERISTICS OF HEAVY HAULING INDUSTRIES

This section outlines key industries in Wisconsin and the impact these industries currently have on the movement of freight in Wisconsin. It also provides evidence of potential areas that could take advantage of size and weight modifications.

### Forest Products

Wisconsin's forest products industry employed approximately 73,000 people at 1,410 firms in 2005, according to the Wisconsin Economic Development Institute. These numbers refer to jobs related to the production of wood, wood products, wooden furniture, and paper, among other related items. About 14.4 percent of the state's manufacturing sector is involved in the forest products industry.

In 28 counties, the paper and forest products industry is the largest employer; in 14 more counties it is among the top three. Rural areas of Wisconsin are home to many of the firms in this industry.

There are numerous manufacturing facilities involved in the forest products industry. Figure 4.3 draws a comparison between paper products facilities in 2002 and 2006. Notably, paper mills saw a decline in the number of facilities during these years.

**Figure 4.3 Wisconsin Forest Products Facilities**

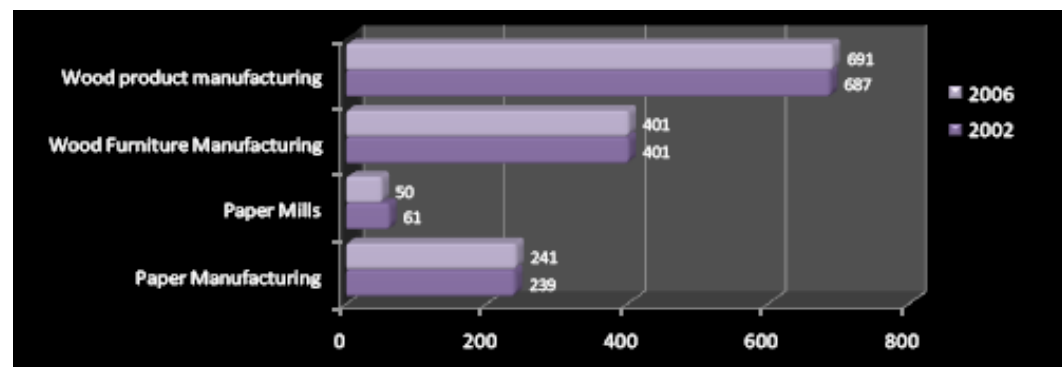

Source: WORKnet (on WDNR Webpage).

Forest products represent over 6.6 percent of all Wisconsin truck shipments by tonnage at nearly 33 million tons. This includes primary forest materials (logs), sawmill production, millwork and prefab construction materials, other wood products, and wooden containers. Many of these mills are found in northern counties of the state. Table 4.10 below generally outlines the counties where wood-related manufacturing plants are found in Wisconsin.

**Table 4.10 Major Wisconsin Forest Products Processing Facilities**

Type of Wood Manufacturing Plant	County			
Large Sawmills (producing 11,000,000+ board feet annually)	Langlade	Vilas	Clark	Sauk
	La Crosse	Florence	Forest	Langlade
	Shawano	Price	Crawford	Marinette
	Wood	Outagamie	Menominee	
Pulp Mills	Wood	Outagamie	Chippewa	Lincoln
	Marinette	Portage	Marathon	
Veneer	Waupaca	Chippewa		
Hardboard	Price			
Particleboard	Lincoln	Sawyer	Wood	Marinette
Treating	Price	Douglas	Eau Claire	Chippewa
	Douglas	La Crosse	Dunn	
Wood Chips	Ashland	Taylor	Shawano	Lincoln
	Sawyer	Jackson		
Wood Pellets	Marathon			
Shavings	Trempealeau	Vernon	Columbia	Langlade

Source: Wisconsin’s Primary Wood Using Industry Database, Department of Forest Ecology and Management, UW-Madison.

It is evident from the Table 4.10 that the majority of wood processing facilities are located in northern Wisconsin. Aside from the processing facilities mentioned, the Wisconsin Primary Wood Using Industry directory also lists 65 manufacturers of log homes in the state, the majority of which are also located in the middle and northern one-half of the State.

Table 4.11 below highlights the counties where most of the lumber and wood products originate.

While Sheboygan and Marathon Counties are the top exporters of lumber and wood products, many Wisconsin counties have a stake in this industry. The top 10 counties only make up 41.5 percent of total originating tonnage, which indicates that the transport of these goods is important to a large number of counties. Table 4.12 below highlights top origin/destination pairs for the transport of lumber and wood.

**Table 4.11 Wisconsin's Top 10 Originating Counties  
for the Transportation of Lumber and Wood Products  
2001**

Originating County	Total Tonnage	Percent of State Tonnage
Sheboygan	1,081,556	7.8%
Marathon	929,312	6.7%
Wood	632,470	4.6%
Douglas	581,550	4.2%
Winnebago	458,922	3.3%
Waupaca	438,146	3.2%
Sawyer	432,358	3.1%
Lincoln	415,191	3.0%
Rusk	393,625	2.9%
Marinette	374,652	2.7%

Source: TRANSEARCH (Global Insight), formerly Reebie & Associates, 2001.

**Table 4.12 Wisconsin's Top 10 Origin/Destination County Pairs  
for the Transportation of Lumber and Wood Products  
2001**

Origin Co.	Destination Co.	Total Tonnage
Marathon	Milwaukee	359,850
Sheboygan	Milwaukee	330,241
Wood	Milwaukee	235,984
Winnebago	Milwaukee	170,045
Lincoln	Milwaukee	155,330
Waupaca	Milwaukee	151,753
Douglas	Wood	150,060
Sawyer	Milwaukee	149,785
Rusk	Milwaukee	144,923
La Crosse	Milwaukee	144,205

Source: TRANSEARCH (Global Insight), formerly Reebie & Associates, 2001.

## Paper Industry

Papermaking has a rich and important history in the state of Wisconsin dating back 150 years. Plentiful supplies of fresh water are necessary for good papermaking, so it was natural for the industry to begin developing further north along the banks of some of the state's major rivers, including the Fox, Wisconsin, Chippewa, Menominee, Peshtigo, Eau Claire, Flambeau and others.

Wisconsin is the nation's number 1 paper manufacturing state and has led the nation in papermaking for more than 50 years. More than 5.3 million tons of paper and over 1.1 million tons of paperboard are produced annually. Pulp, paper, and allied firms employ more than 40,000 men and women, representing one in every 12 state manufacturing jobs. Pulp and paper manufacturing account for about 60 percent of the jobs in the paper industry; 40 percent of jobs are in converting operations that transform jumbo paper rolls into the widest variety of paper products made in any state.

The value of shipments from Wisconsin's paper companies tops \$12.4 billion annually, while combined shipments of paper, lumber and wood products are valued at nearly \$16.8 billion. Pulp and paper shipment was 3.5 percent of all truck tonnage in 2001 at over 17.5 million tons. Much of this production stems from the northeastern part of the state, around the Fox Valley and Green Bay regions. Figure 4.4 displays the location of Wisconsin's paper mills. The total truck count information on the map below and other maps in this section were provided by WisDOT staff.

Recently, the paper industry has come under stress due to foreign competition and high prices of oil and fiber. It is estimated that Wisconsin lost around 10,000 jobs between 2000 and 2004 in the pulp, paper, and printing sectors (Wisconsin DNR).

Table 4.13 displays the top 10 originating counties for paper and pulp in the State.



Figure 4.4 Paper Mills in Wisconsin

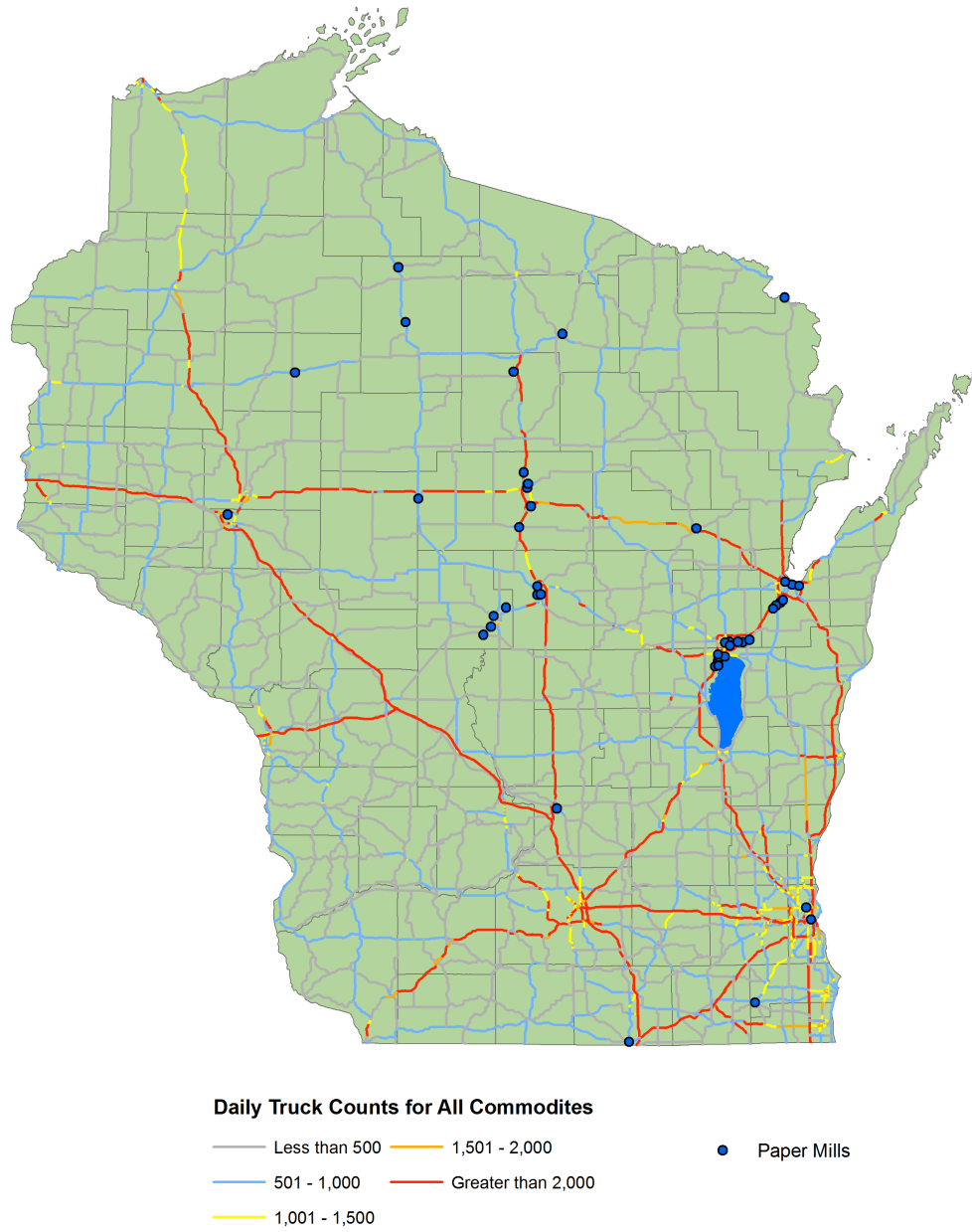

Source: Wisconsin Paper Council.

**Table 4.13 Wisconsin’s Top 10 Originating Counties for the Transportation of Paper and Pulp  
2001**

Origin County	Total Tonnage	Percent of State Tonnage
Outagamie	983,762	21.4%
Winnebago	793,789	17.2%
Brown	666,396	14.5%
Milwaukee	287,620	6.2%
Wood	253,988	5.5%
Price	233,525	5.1%
Marathon	217,165	4.7%
Marinette	196,406	4.3%
Waukesha	134,049	2.9%
Portage	116,669	2.5%

Source: TRANSEARCH (Global Insight), formerly Reebie & Associates, 2001.

Outagamie, Winnebago, and Brown are counties in the Fox River Valley, and they comprise over 50 percent of the state’s paper originating tonnage. Table 4.14 below shows the top origin/destination pairs for pulp/paper transport in the state.

**Table 4.14 Wisconsin’s Top 10 Origin/Destination County Pairs for the Transportation of Paper and Pulp  
2001**

Origin County	Destination Co.	Total Tonnage
Outagamie	Milwaukee	297,824
Winnebago	Milwaukee	244,693
Brown	Milwaukee	215,861
Outagamie	Dane	80,528
Wood	Milwaukee	79,129
Outagamie	Brown	76,353
Winnebago	Brown	72,941
Price	Milwaukee	71,383
Marathon	Milwaukee	69,331
Winnebago	Dane	66,619

Source: TRANSEARCH (Global Insight), formerly Reebie & Associates, 2001.

Milwaukee County is the recipient of much of the Fox River Valley's transported paper and pulp. Dane County also is a recipient of much paper and pulp products from these regions. Thus, many of the north/south routes heading to Madison and Milwaukee are critical for hauling this heavy freight.

### Machinery and Transportation Equipment

Machinery is Wisconsin's largest manufacturing industry group as measured by output, constituting 13.4 percent of the state's value-added from manufacturing in 2000, as measured by the Northeast Midwest Institute State by State Manufacturing Synopsis. Within this category, the production of engine, turbine, and power transmission equipment accounted for more than 25 percent of the value added from the state's machinery industries. Also, in 2000, the percentage of Wisconsin's workforce employed in the manufacturing of nonelectrical machinery was the largest of any state in the country. Freight that supports the production of machinery is focused in the southeastern part of the state. Table 4.15 shows the top 10 originating counties for machinery transport.

**Table 4.15 Wisconsin's Top 10 Originating Counties  
for the Transportation of Machinery  
2001**

Origin Co.	Total Tonnage	Percent of State Tonnage
Milwaukee	83,204	17.8%
Waukesha	46,093	9.9%
Racine	30,928	6.6%
Fond du Lac	29,326	6.3%
Dane	24,114	5.2%
Winnebago	23,422	5.0%
Brown	22,377	4.8%
Outagamie	20,241	4.3%
Ozaukee	14,537	3.1%
Calumet	14,435	3.1%

Source: TRANSEARCH (Global Insight), formerly Reebie & Associates, 2001.

Milwaukee and Waukesha counties produce over a fourth of Wisconsin's machinery transportation movements. However, as is shown in Table 4.16, it is evident that much of the Milwaukee County originating traffic also terminates within this County.

**Table 4.16 Wisconsin's Top 10 Origin/Destination County Pairs for the Transportation of Machinery 2001**

Origin County	Destination Co.	Total Tonnage
Milwaukee	Milwaukee	59,735
Waukesha	Milwaukee	33,355
Racine	Milwaukee	21,861
Fond du Lac	Milwaukee	20,761
Fond du Lac	Milwaukee	20,761
Dane	Milwaukee	20,027
Winnebago	Milwaukee	19,019
Brown	Milwaukee	18,327
Outagamie	Milwaukee	16,425
Calumet	Milwaukee	11,850

Source: TRANSEARCH (Global Insight), formerly Reebie & Associates, 2001.

Table 4.16 shows that Milwaukee County is the destination county for all top 10 origin/destination pairs for machinery transport. This county is also the destination county for 19 of the top 20 pairs. From the table, it is evident that there is substantial movement of machinery happening throughout the southeastern region of the state, especially on the road network leading into Milwaukee County from surrounding counties such as Waukesha, Racine, Fond du Lac and others.

Several Department of Defense contracts have resulted in work for a heavy machinery manufacturer in the Fox River Valley area. One contractor also repairs vehicles coming back from deployments abroad. These movements typically are permitted oversize/overweight loads. The number of trips has increased significantly since the 2004 time period.

Wisconsin's transportation equipment manufacturing industry is an important part of the state's economy. Overall, the transportation equipment manufacturing industry sector accounted for 12.6 percent of the state's added value manufacturing numbers.

For 2001, machinery, transportation, and electrical equipment comprised nearly 3 percent of all truck movements, totaling over 15 million tons.

### **Agricultural Products**

The State of Wisconsin is presently ranked as one of the top 10 agriculture producing states in the nation. Wisconsin is also one of the most diverse agricultural production states in the nation, producing a variety of dairy, livestock, vegetables, crops, and nursery stock. In addition, the state is home to

over 1,000 food processing firms. Table 4.17 below outlines the top agricultural commodities produced in Wisconsin, by value.

**Table 4.17 Wisconsin's Top Agricultural Commodities  
by Dollar Value**

Rank	Commodity	Value (2006)
1	Milk	\$3.53 billion
2	Cattle and calves	\$877 million
3	Corn	\$589 million
4	Greenhouse and nursery	\$237 million
5	Soybeans	\$240 million
6	Potatoes	\$162 million
7	Cranberries	\$124 million
8	Hogs	\$120 million
9	Hay	\$90 million
10	Broilers	\$70 million

Source: Wisconsin Agricultural Statistics Service, 2006.

Figure 4.5 displays the number of farms located in each county. As expected, urban areas (such as Milwaukee) and areas where the forestry industry is dominant (northern Wisconsin) are not heavy agricultural areas. Much of the rest of the state has a large number of farms, in particular the counties of Dane, Grant, Vernon, Marathon, and Clark. While this visual does not indicate the density of farming in each county, it does provide a good general picture of areas in Wisconsin that are critical to the agriculture industry.

**Figure 4.5 Farms in Wisconsin by County**

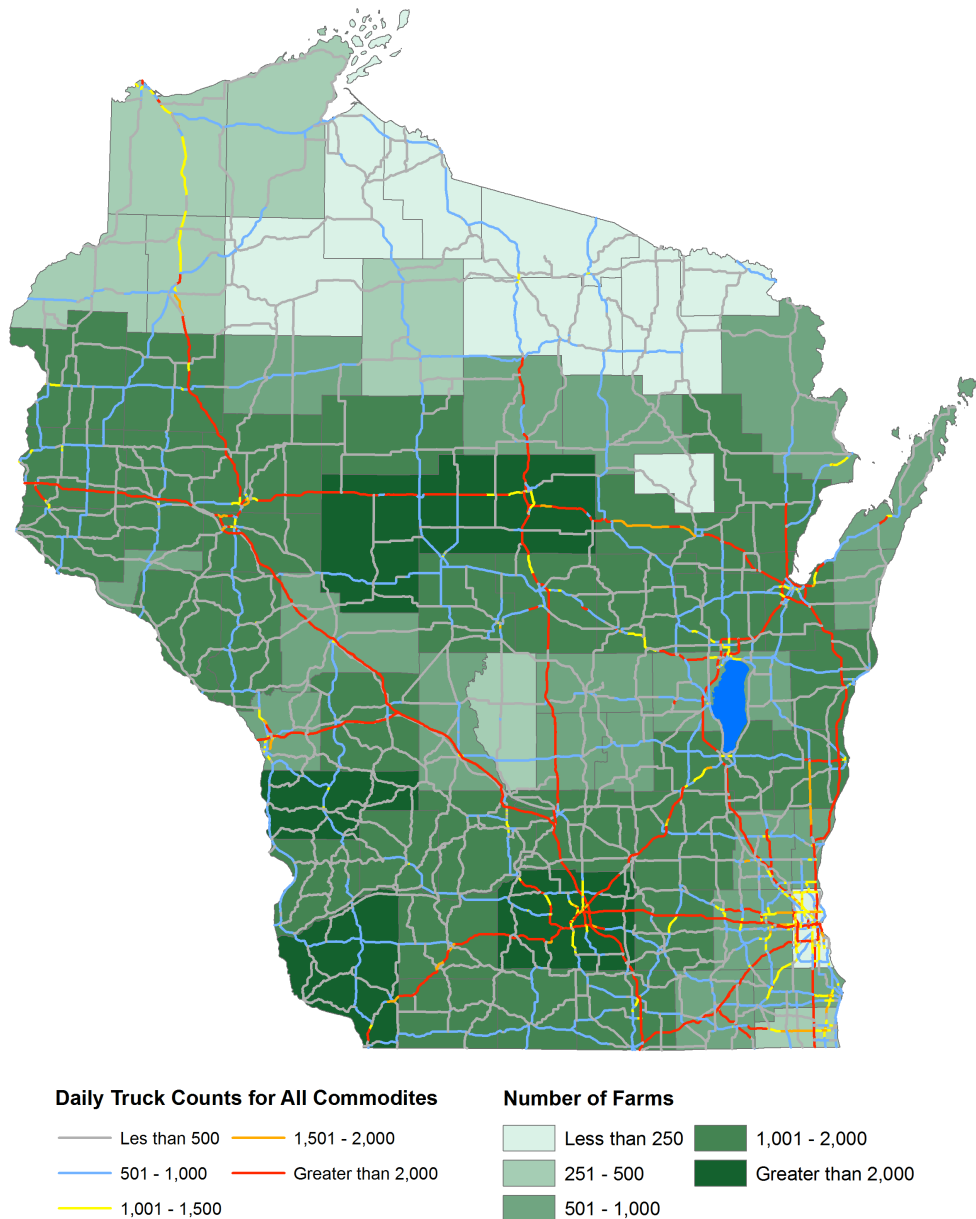

Source: National Agriculture Statistics Service, 2006.

With 76,000 farms currently in production, agricultural products require a high volume of transport during harvest and processing seasons, including significant overweight and oversize transport.

The number of farms in Wisconsin in 2007 remained steady from 2006 numbers. See Table 4.18 below for an overview of Wisconsin farms by economic sales class. Total acres of farmland in Wisconsin saw a slight decline of 100,000 acres, resulting in a 2007 total of 15.2 million acres. The average size of farms in the

state was approximately 200 acres. In 2007, there were 4,400 farms with sales of \$250,000 to \$499,999, and 2,700 farms with sales of \$500,000 or more. Farms with sales of \$10,000 to \$99,999 and with sales of \$100,000 to \$249,999 were unchanged from the previous year, at 21,300 and 11,600, respectively. The only category with fewer farms was the group with \$1,000 to \$9,999 in gross sales, down 200 to 36,000. Nationally, the number of farms in the U.S. in 2007 declined 1 percent from the previous year. There were 2.08 million farms in the nation with 931 million acres of land in farms. The average American farm size is 449 acres, double Wisconsin's average farm size.

**Table 4.18 Wisconsin Farms by Economic Sales Class**  
2006 to 2007

Economic Class (Gross Value of Sales)	Number of Farms		Land in Farms		Average Size of Farms	
	2006	2007	2006	2007	2006	2007
	Number		Thousand Acres		Acres	
\$1,000-\$9,999	36,200	36,000	2,800	2,500	77	69
\$10,000-\$99,999	21,300	21,300	3,600	3,700	169	174
\$100,000-\$249,999	11,600	11,600	3,300	3,300	284	284
\$250,000-\$499,999	4,300	4,400	2,700	2,700	628	614
\$500,000 and over	2,600	2,700	2,900	3,000	1,115	1,111
<b>Total</b>	<b>76,000</b>	<b>76,000</b>	<b>15,300</b>	<b>15,200</b>	<b>201</b>	<b>200</b>

Source: USDA, NASS, 2008.

Wisconsin's agricultural products moving by truck represent 10.31 percent of all truck trips in the state and over 51 million tons of freight. In 2001, field crops comprised 9.4 percent of all truck movements in the state. Food and kindred food products comprised 8.64 percent of all truck shipments and nearly 43 million tons of product, led by miscellaneous prepared foods (frozen foods and similar products) and beverages.

The sections below provide an overview of the major agricultural commodities produced in Wisconsin.

### Corn for Silage

Wisconsin produces more corn for silage than any other state in the nation, with over 14 million tons produced annually. The top counties for this activity are Marathon, Clark, Manitowoc, Dane, Shawano, and Outagamie. Most corn for silage is not shipped long distances; however, high quality silage is increasingly being used as feeds, and is being distributed throughout a larger radius.

**Figure 4.6 Tons of Wisconsin Corn for Silage Production by County**

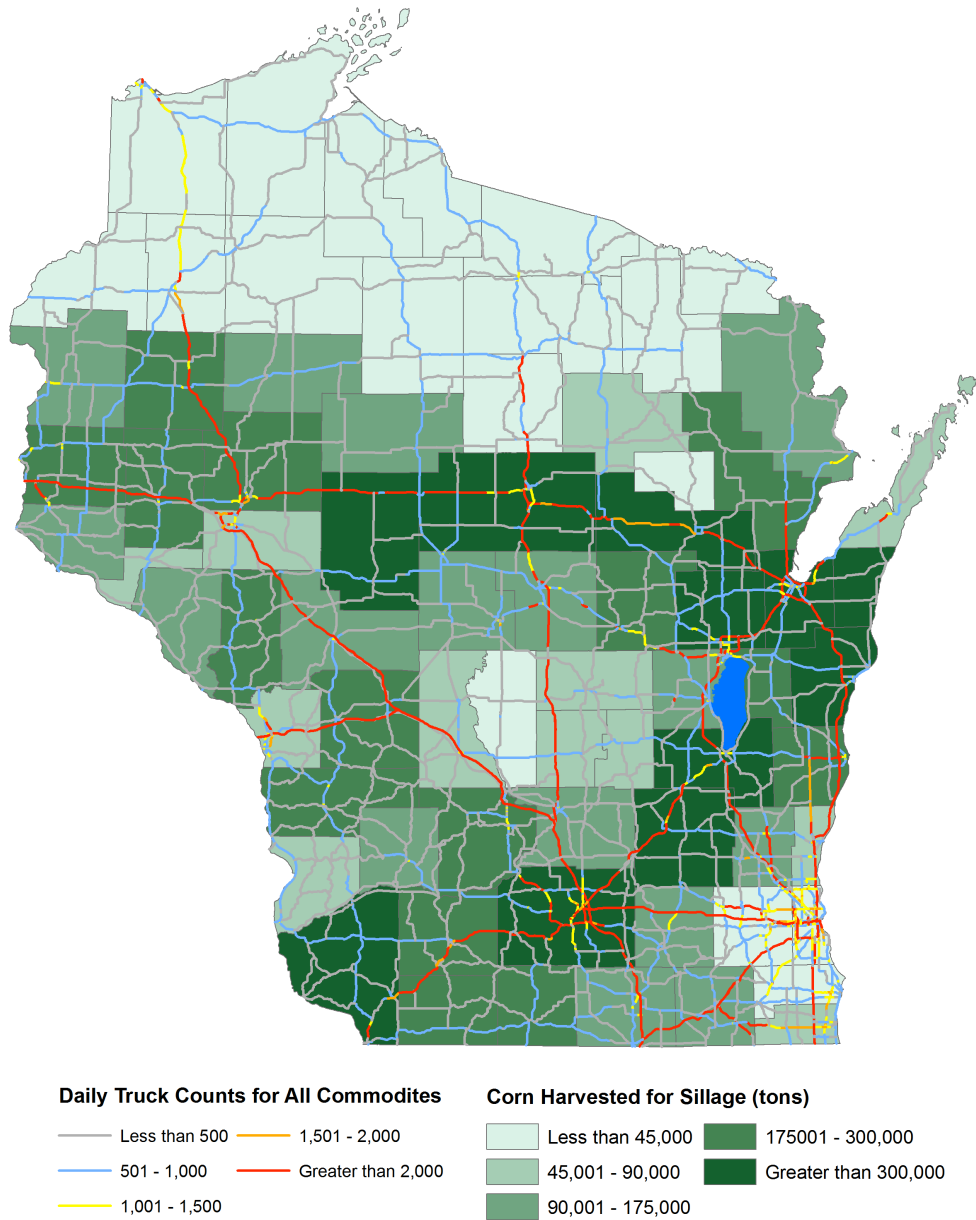

Source: National Agriculture Statistics Service, 2006.

### Hay and Other Silage

Wisconsin is a leading producer of hay and other grass-based silage. Figure 4.7 highlights production of these items per county. The counties that produce the most hay and grass-based silage are Marathon, Clark, and Grant Counties; however, all states have some level of hay and related production. The feed



stocks here generally do not travel significant distances, and generally remain within the state of Wisconsin.

**Figure 4.7 Wisconsin Hay and Other Silage Production (Dry Tons)**

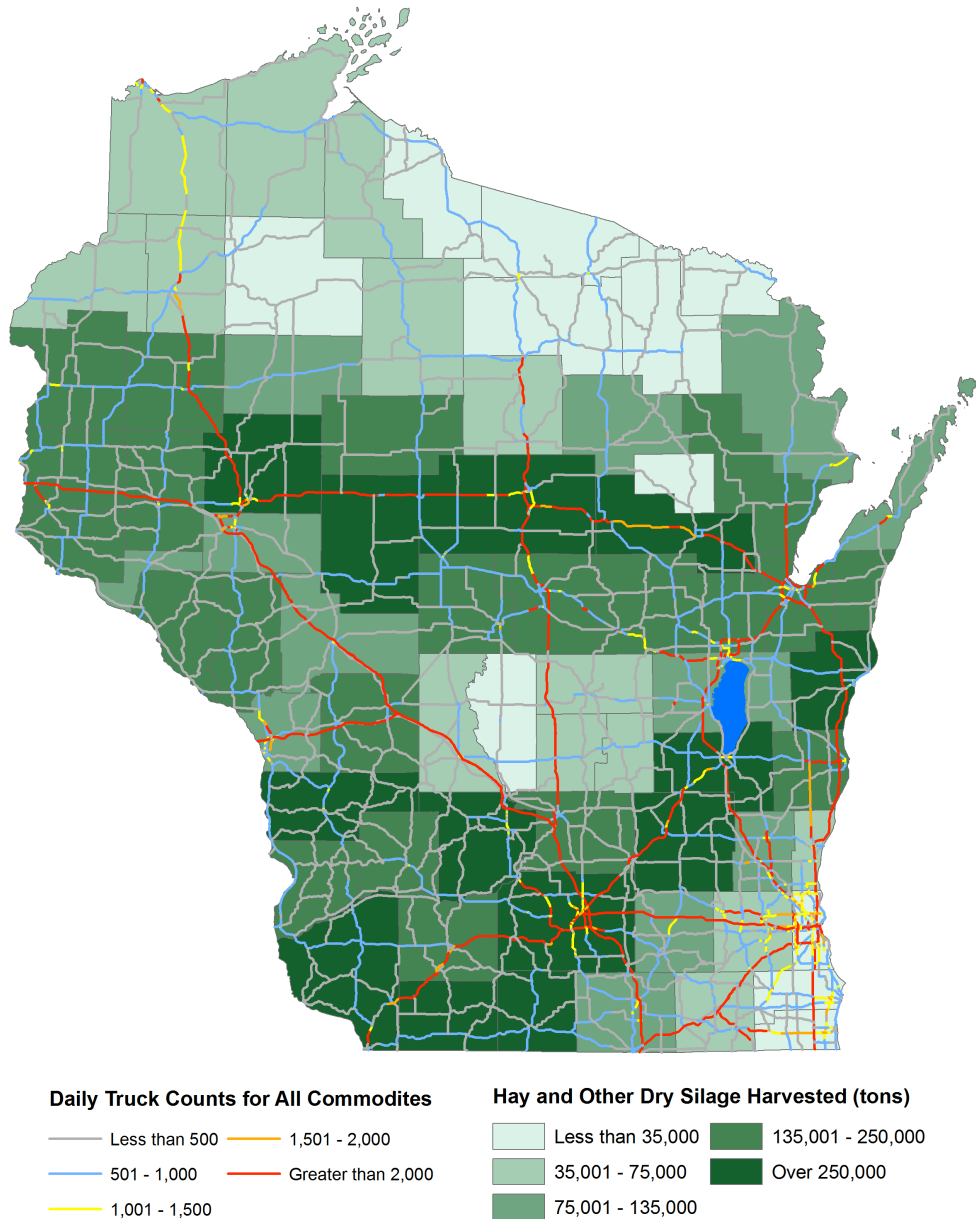

Source: National Agriculture Statistics Service, 2006.

### Milk Cows and Dairy Products

While the dairy farming sector is the most visible element of the Wisconsin dairy industry, the dairy manufacturing sector, including products such as cheese and milk, is responsible for the largest value added. In 2001, the Wisconsin Department of Agriculture, Trade, and Consumer Protection counted 364 dairy

plants in the state making a wide variety of products. Dairy plants are scattered throughout Wisconsin.

While it is difficult to accurately estimate the fraction of the state's milk supply devoted to cheese production, the percentage is likely between 80 to 90 percent, according to the Wisconsin Milk Marketing Board. Other major manufactured dairy products include butter, cottage cheese, and whey products. Only 6 to 8 percent of Wisconsin milk is used for liquid milk products. Dairy products moved by truck represent just over 1 percent of the state's total tonnage, equating to over 5 million tons in 2001.

In 2000, Wisconsin produced 2.2 billion pounds of natural cheese, approximately 27 percent of total U.S. cheese production.

Cheddar and Mozzarella cheese accounted for about two-thirds of the 2.2 billion pounds produced in the year 2000. Overall, the state produces at least 50 identifiable cheese varieties. Specialty cheese production (defined generally as "value-added" varieties with annual production less than 40 million pounds) is growing rapidly. In 2000, more than 220 million pounds of specialty cheese varieties were manufactured in the state, 10 percent of total cheese production, up from 4 percent in 1993. One-half of Wisconsin's cheese factories produces at least one specialty variety. Wisconsin also produced just over 1 billion pounds of processed cheese products in 2000, about one-half of U.S. production.

With respect to milk cows, the state continues to reduce the size of its dairy herds while simultaneously increasing overall milk and dairy production slightly. Figure 4.8 below gives an overview of milk cow location in the State.

## Oats

Wisconsin's 2008 oat production is forecast at 10.9 million bushels, up from 10.7 million bushels in 2007. The 1 percent increase in production can be attributed to a one bushel increase in yield from last year. Wisconsin farmers plan to harvest 160,000 acres for grain, equal to 2007 levels. Yields are expected to be 68 bushels per acre, up from 67 bushels in 2007.

One bushel of oats is approximately 42 pounds. This results in over 300,000 tons of oats being grown in Wisconsin. Wisconsin consistently is in the top 3 states for oats production.

The top counties for oat production in Wisconsin are: Grant, Langlade, Manitowoc, and Clark. See Figure 4.9 for an overview of where oats are produced in Wisconsin. Oats are processed for export in Superior, shipped to grain elevators for barge transport on the Mississippi, or sent to local elevators near the harvest sites for processing into final products. The principal routes serving the Oats production markets are U.S. 151, U.S. 41, U.S. 61, and U.S. 52. Interstate 39, U.S. 8, and U.S. 2 are also primary routes.

**Figure 4.8 Wisconsin Location of Milk Cows by Head**

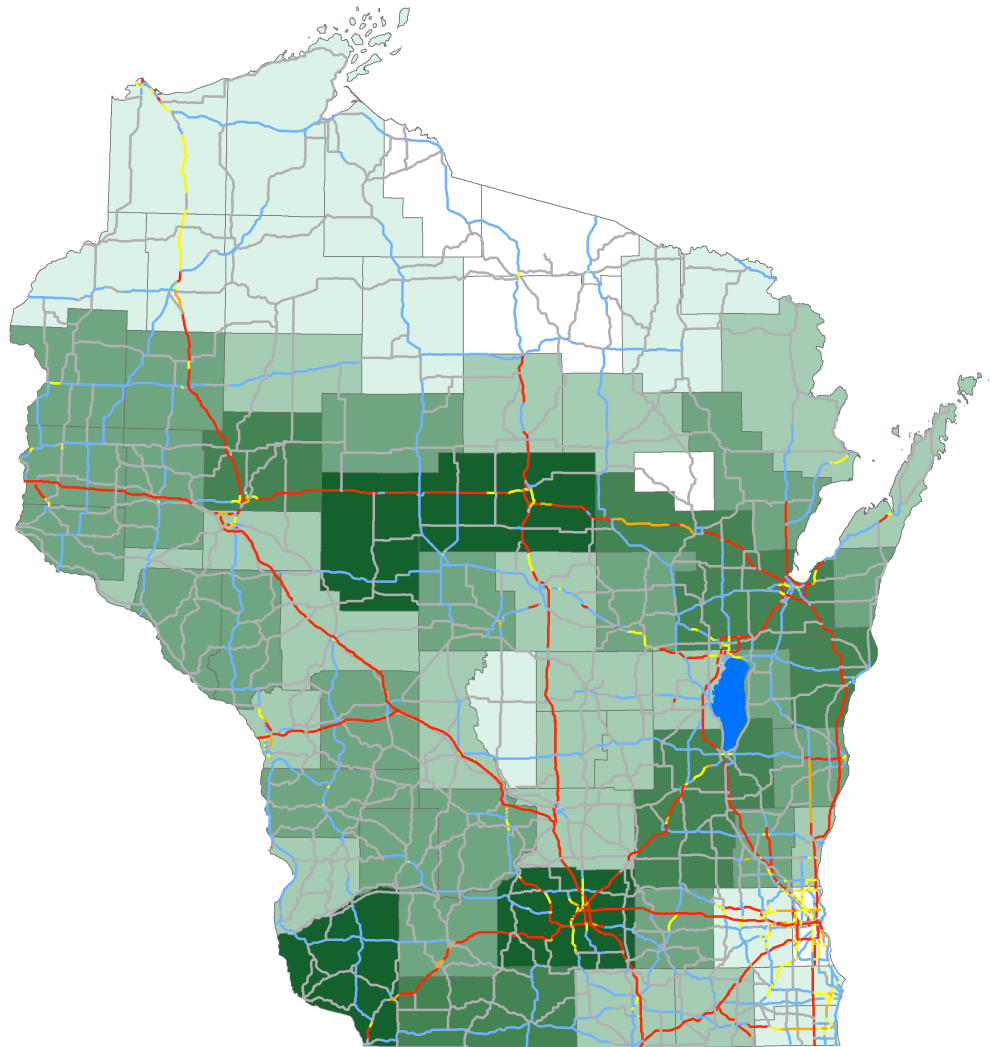

**Daily Truck Counts for All Commodites**

- Less than 500
- 501 - 1,000
- 1,001 - 1,500
- 1,501 - 2,000
- Greater than 2,000

**Milk Cows (by head)**

- Less than 5,000
- 5,001 - 15,000
- 15,001 - 30,000
- 30,001 - 45,000
- Greater than 45,000
- No data or data withheld

Source: National Agriculture Statistics Service, 2006.

**Figure 4.9 Wisconsin Oats Production (Tons)**

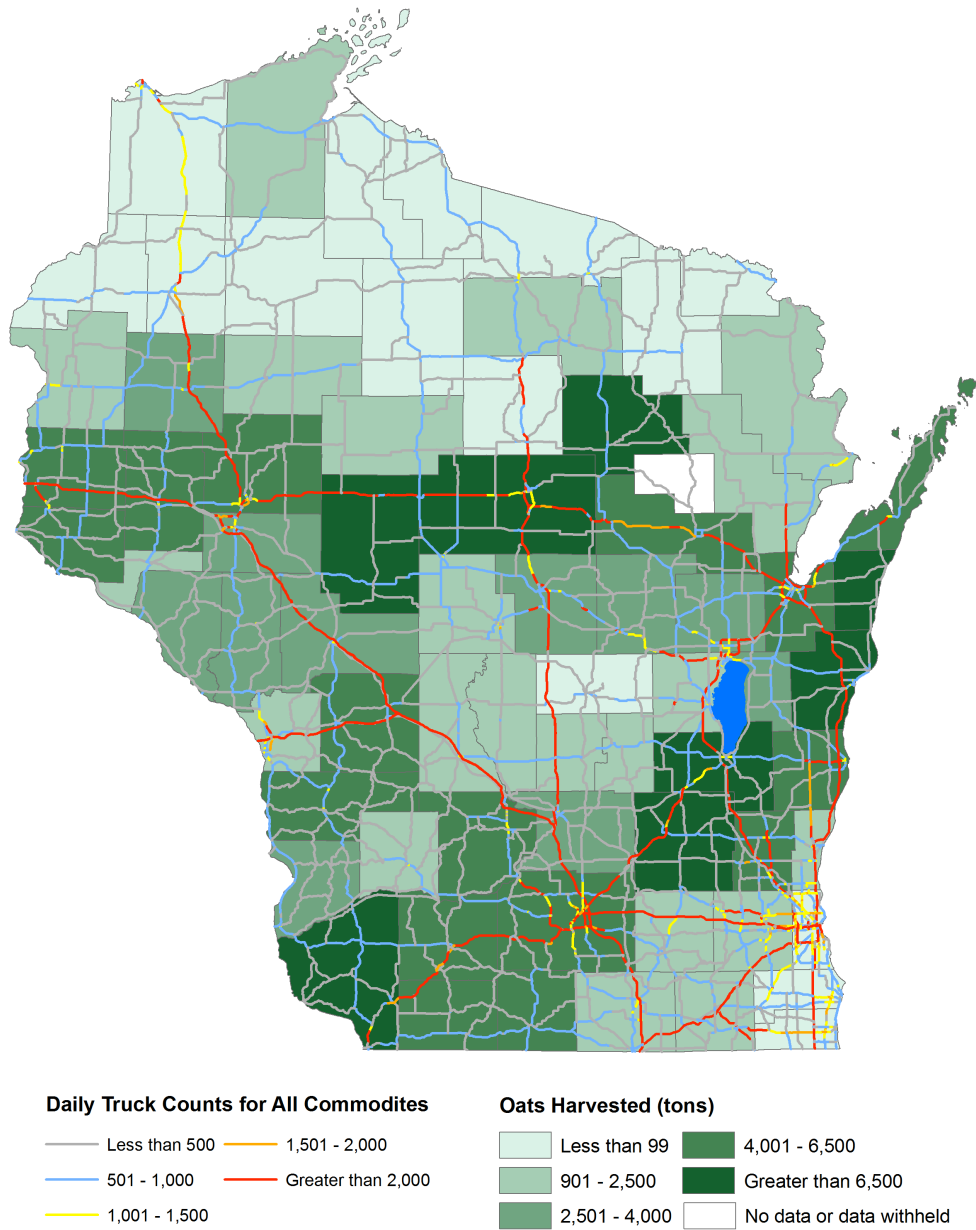

Source: National Agriculture Statistics Service, 2006.

## Potatoes

Wisconsin is the third largest potato producing state with over 2.94 billion pounds grown in 2006. Wisconsin ranks among the nation's leaders in yields per acre of U.S. No. 1 potatoes and has approximately 66,000 acres of harvested potatoes as of 2006. Wisconsin ships over 1.5 million tons of potatoes each year by truck to processing and retail locations. Many Wisconsin potato shippers own their own fleet of trucks or provide brokering services.

According to statistics of the Wisconsin Potato and Vegetable Growers Association, over 42,000 truckloads of potatoes are shipped in Wisconsin during the August to October harvest season. The truckloads typically weigh out at 42,500 pounds per average payload (plus equipment, packaging, and pallets, with 18 pallets per truckload). Many of these truckloads are sent to one of 14 processing plants throughout the state and region.

Portage, Waushara, Adams, and Langlade counties lead the state in production. To get potatoes to primary processing facilities, the principal road network components are U.S. 10 and 29, WIS 49, 66, 161, and 54. Loads also travel on U.S. 51 and Interstate 39 to processing centers in Rosholt. See Figure 4.10 for more information on where potatoes are produced in the State.

## Soybeans

Dane, Rock, Dodge, Grant, and Lafayette counties lead Wisconsin in soybean production. As a state, Wisconsin produces over 2 million tons of soybeans annually. Soybean acreage in Wisconsin is likely to increase for 2008 as growers rotate away from corn due to concern over the high cost of fertilizer, seed corn, and other crop inputs. Presently Wisconsin farmers plant about 1.4 million acres of soybeans. Figure 4.11 below highlights the Wisconsin counties where soybeans are produced.

Wisconsin was the 13<sup>th</sup> largest soybean producing state in 2005, with a crop of 69.5 million bushels (2.085 million tons). As Wisconsin is the only state among the top 13 soybean producing states that lacks a soybean processing plant, all soybeans produced in Wisconsin leave the state to find markets, the nearest of which are 130 miles from Madison. Southern Wisconsin is the center of the State's soybean production. One small expeller plant is currently in operation at Valders.

As a result of the need to transport soybeans to Cedar Rapids Iowa, U.S. 151 becomes a major route for soybean shipments from Dane County and the surrounding area. Other primary destinations for soybeans currently include Archer Daniels Midland facilities in Mankato, Minnesota and Galesburg, Illinois.

**Figure 4.10 Wisconsin Potatoes Production  
In Tons**

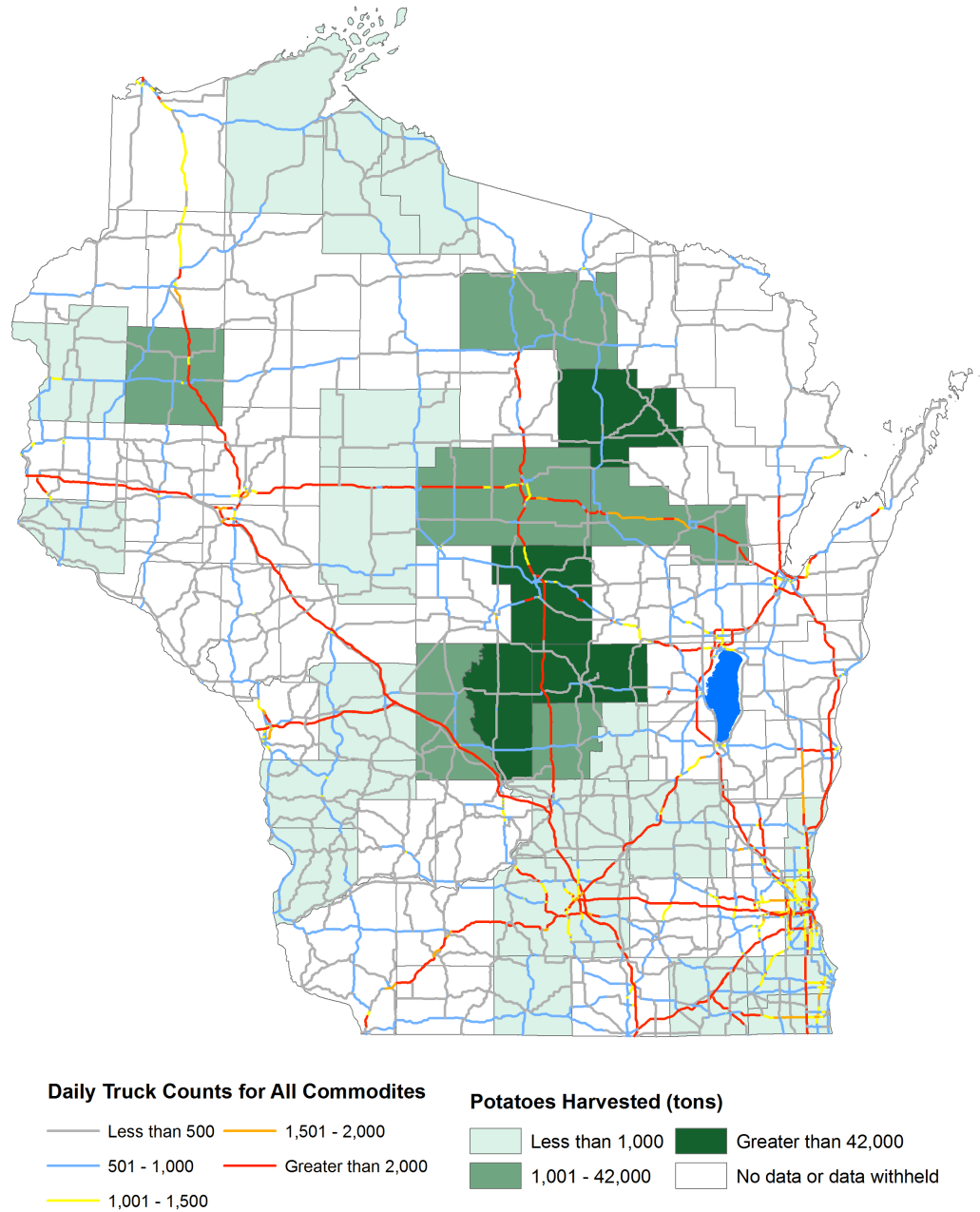

Source: National Agriculture Statistics Service, 2006.

**Figure 4.11 Wisconsin Soybean Production (Tons)**

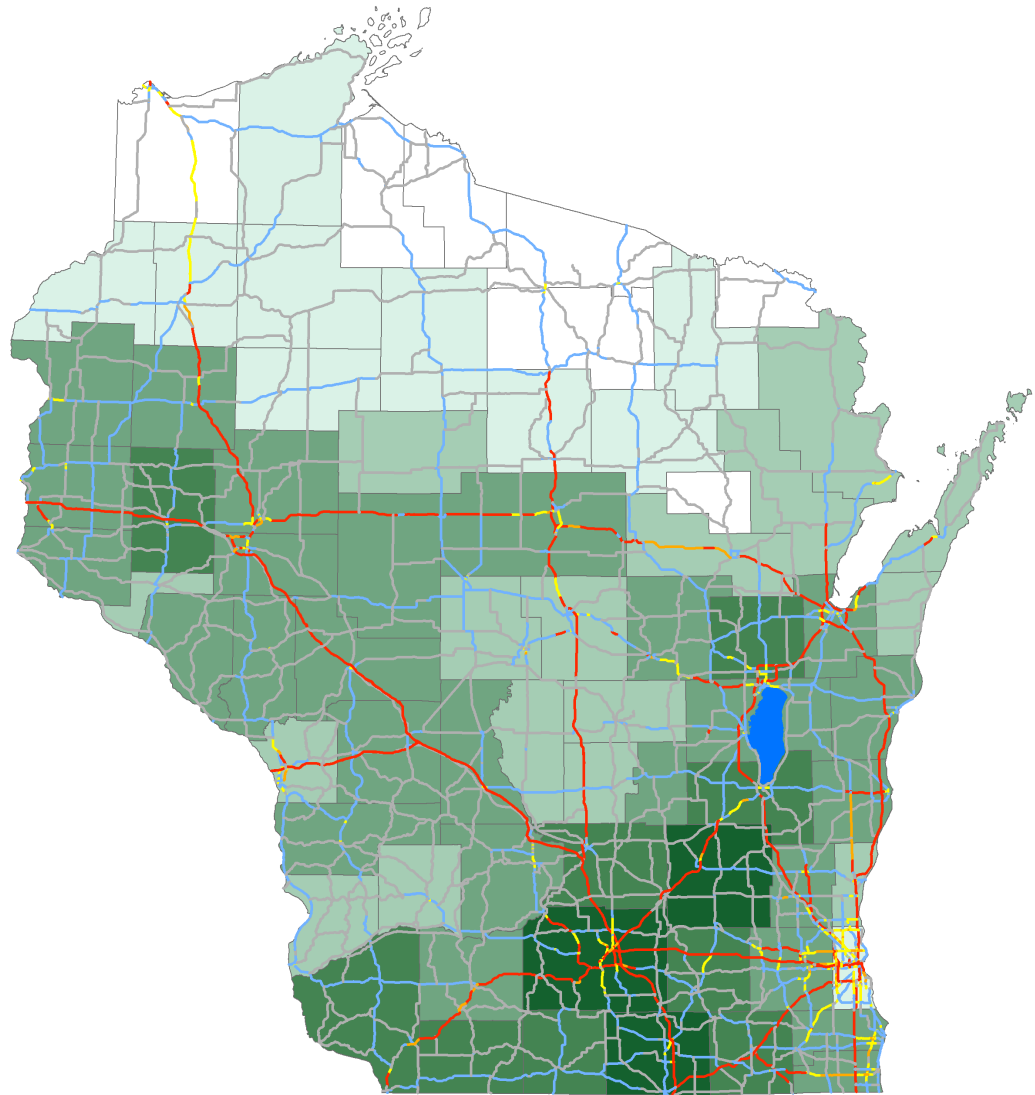

**Daily Truck Counts for All Commodites**

- Less 500
- 501 - 1,000
- 1,001 - 1,500
- 1,501 - 2,000
- Greater than 2,000

**Soybeans Harvested (tons)**

- Less than 6,000
- 6,001 - 20,000
- 20,001 - 45,000
- 45,001 - 80,000
- Greater than 80,000
- No data or data withheld

Source: National Agriculture Statistics Service, 2006.

## Wheat

Wisconsin has had a resurgence of wheat production in the last five years, most notably on Washington Island in Door County. Currently wheat is receiving increased attention in Wisconsin as a rotational crop. 175,000 acres of wheat were harvested in 2005, resulting in 9.9 million bushels of wheat. See Figure 4.12 below for the distribution of wheat production in Wisconsin. It is visible from this graphic that wheat production is concentrated in the eastern one-half of the State.

**Figure 4.12 Wisconsin Wheat Production (Tons)**

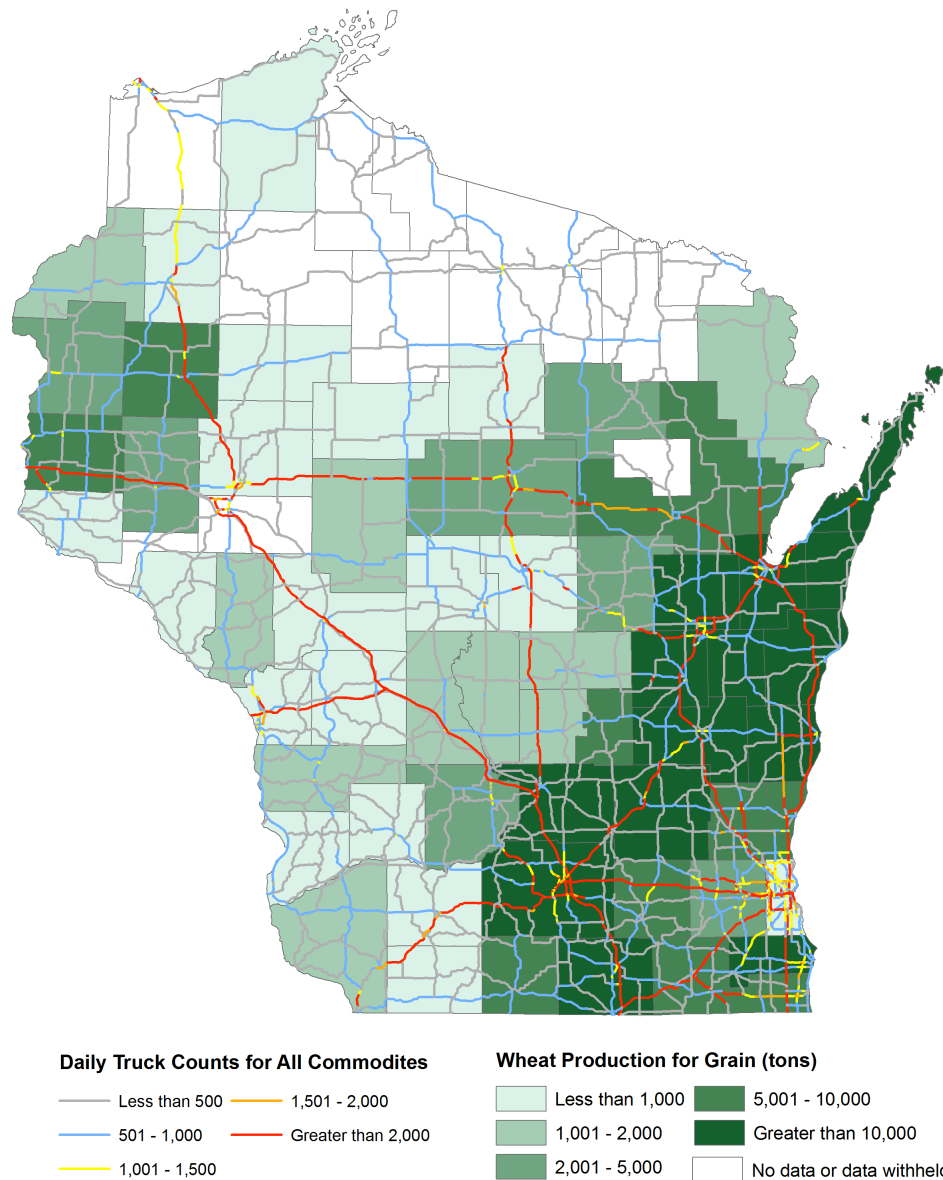

Source: National Agriculture Statistics Service, 2006.



## **Foundry Industry**

Wisconsin is ranked third nationally with respect to volume and value of the foundry industry. There are 150 actively operating foundries in the state with an annual payroll of \$870 million. Wisconsin produced 1.7 million tons of aluminum castings. The value of castings produced in Wisconsin in 2006 was \$3.5 billion.

The foundry industry is also an important contributor to other heavy hauling commodities. Scrap is a primary melt stock (raw material) as well as a byproduct of the production process. Sand deliveries are also necessary for the production cycle. Coal is used to heat metals prior to casting and is mixed with sand in other heat intensive casting processes. Foundries send finished products to equipment and machinery manufacturing plants across the state and region, not to mention internationally. Small engines and engine pieces are also cast in Wisconsin's foundries for production at other Wisconsin plants.

Foundries are clustered in the Fox River Valley area and the southeastern part of the State. The largest state foundry receives 5 truckloads of sand per day, traversing approximately 50 miles one-way. See Figure 4.13 for location of Wisconsin foundries.

## **Wisconsin Sand, Concrete, and Gravel Industries**

Since sand is a critical component for the foundry industry, Wisconsin is a top state for the production of this commodity. Wisconsin currently moves over 45.7 million tons of sand and gravel by truck. Much of the sand is mined in the central part of the state and trucked to foundries using U.S. 41 and U.S. 44.

Varying configurations are used in the industry, including both single unit and trailer vehicles. Sand is also combined with other materials that are used in other industries. Most notably, sand is mixed with binders and various chemicals, including carbon dioxide, to be used in the oil and gas extraction activities.

Wisconsin is recognized worldwide for its superior sand products and has utilized both trucks and rail to move product. There are concerns about the ability of smaller end customers to accept shipments that have larger weights at their production facilities.

With respect to shipments, nonmetallic minerals, of which sand and gravel shipments are a significant component, represent over one-third of the total truck tonnage for Wisconsin. Nearly 167 million tons of nonmetallic minerals were moved by truck in 2001. Sand movements in the state of Wisconsin represent 15 percent of the total national weight for sand movements by truck.

Concrete represents 4.25 percent of all truck movements in the state by weight, just over 21 million tons in 2001. The rest of the clay, concrete, glass, and stone category tallied 16.3 million tons in 2001.

Figure 4.13 Wisconsin Foundries

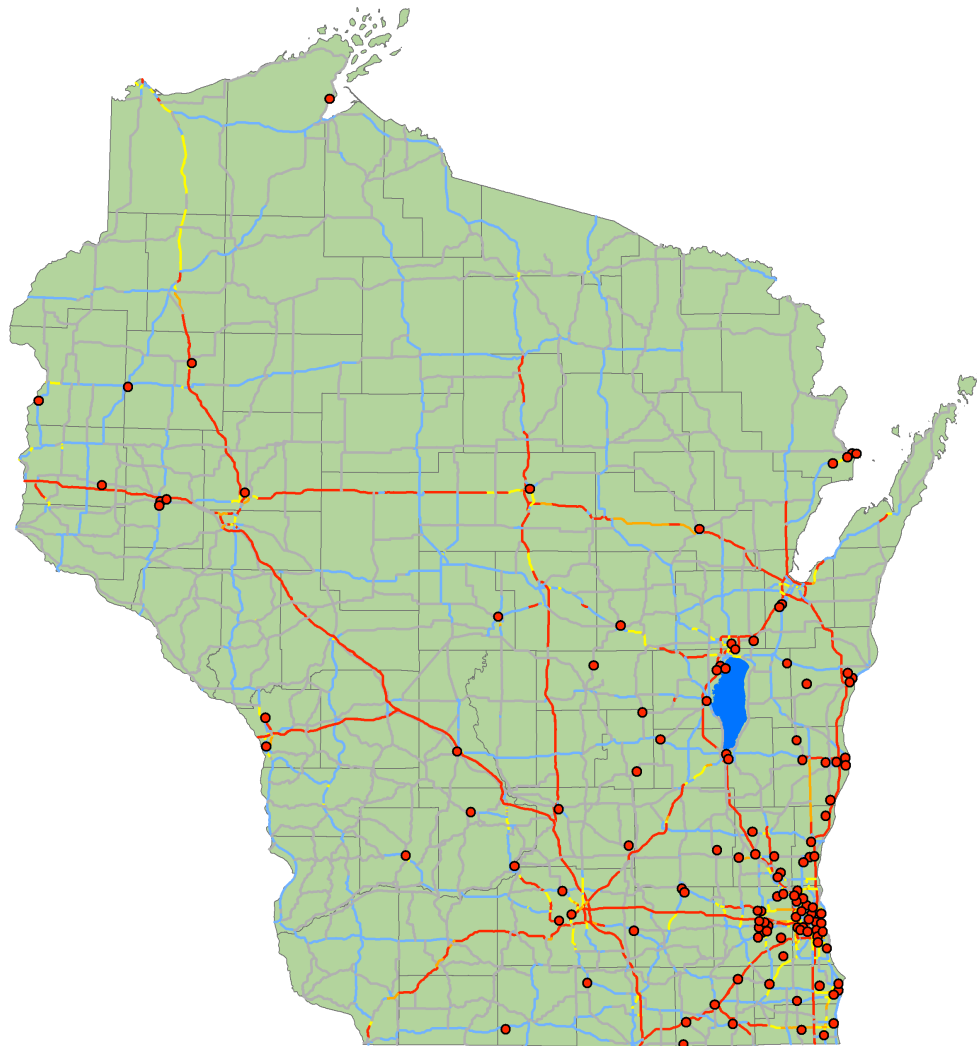

**Daily Truck Counts for All Commodites**

- Less than 500
- 501 - 1,000
- 1,001 - 1,500
- 1,501 - 2,000
- Greater than 2,000
- Foundries

Source: Wisconsin Cast Metals Association.

## **Wisconsin Printing Industry**

Similar to the paper industry, large commercial printer production in the state requires heavy truckloads to transport the finished product between production facilities and distribution centers. Magazines, newspapers, and specialty packaging have emerged as short-haul trips totaling less than 30 miles one-way. In the case of southeastern Wisconsin, over 80 trucks a week are destined outbound from a single large printing firm while over 100 per day circulate at allowable weight limits between five southeastern Wisconsin production facilities. A Wisconsin-based printer estimates that additional weight allowances could reduce the number of trucks required for plant to plant operations.

Drop shipments of finished products are often constrained to specified delivery options. As such, some movements may not be well suited for changes in size or weight allowances. In 2001, printed matter represented over 3.5 million tons in the state and approximately 1 percent of all truck movements.

## **Wisconsin Wind Farms**

Wind energy recently has seen exponential increases in demand in many regions, including Wisconsin. Studies show that the wind levels in the eastern part of the state are especially suitable for wind energy generation. As a result, this part of the state is where many current and planned wind farms are located. Various manufacturers in the eastern part of the state produce approximately \$1.5 billion worth of wind energy components. Many of the components for Wisconsin wind farms, however, are imported via large cargo ships from Europe through the St. Lawrence Seaway, terminating at Wisconsin ports, including the Port of Milwaukee, Port of Marinette/Menominee, the Port of Manitowoc, and the Port of Duluth/Superior. Fond du Lac County is an example of a county that is heavily investing in wind farms, and as a result, many of the wind farm components are moving from the ports to this general region. See Figure 4.14 for an overview of current and planned wind farms in the State.

Currently, large trucks are primarily moving wind farm components in Wisconsin after arriving at these ports, but railroads are planning to become more involved in the general transportation of these products. The trucks carrying these heavy components have a large impact on roads, as various heavy products are required for final production of the wind farm. This includes the transport of 1) turbine tower components to the site, 2) heavy equipment used for assembling the towers, and 3) materials for construction of the electrical substation and heavy transformers in the substation. According to a recent WisDOT study, a total of 2,100 truck trips are needed for the construction of a 50 medium-turbine wind farm. Transportation of many wind farm components requires oversize and/or overweight permits. This process requires coordination with transportation agencies and municipalities for permitting and planning of these trips.

Figure 4.14 Wisconsin Wind Farms

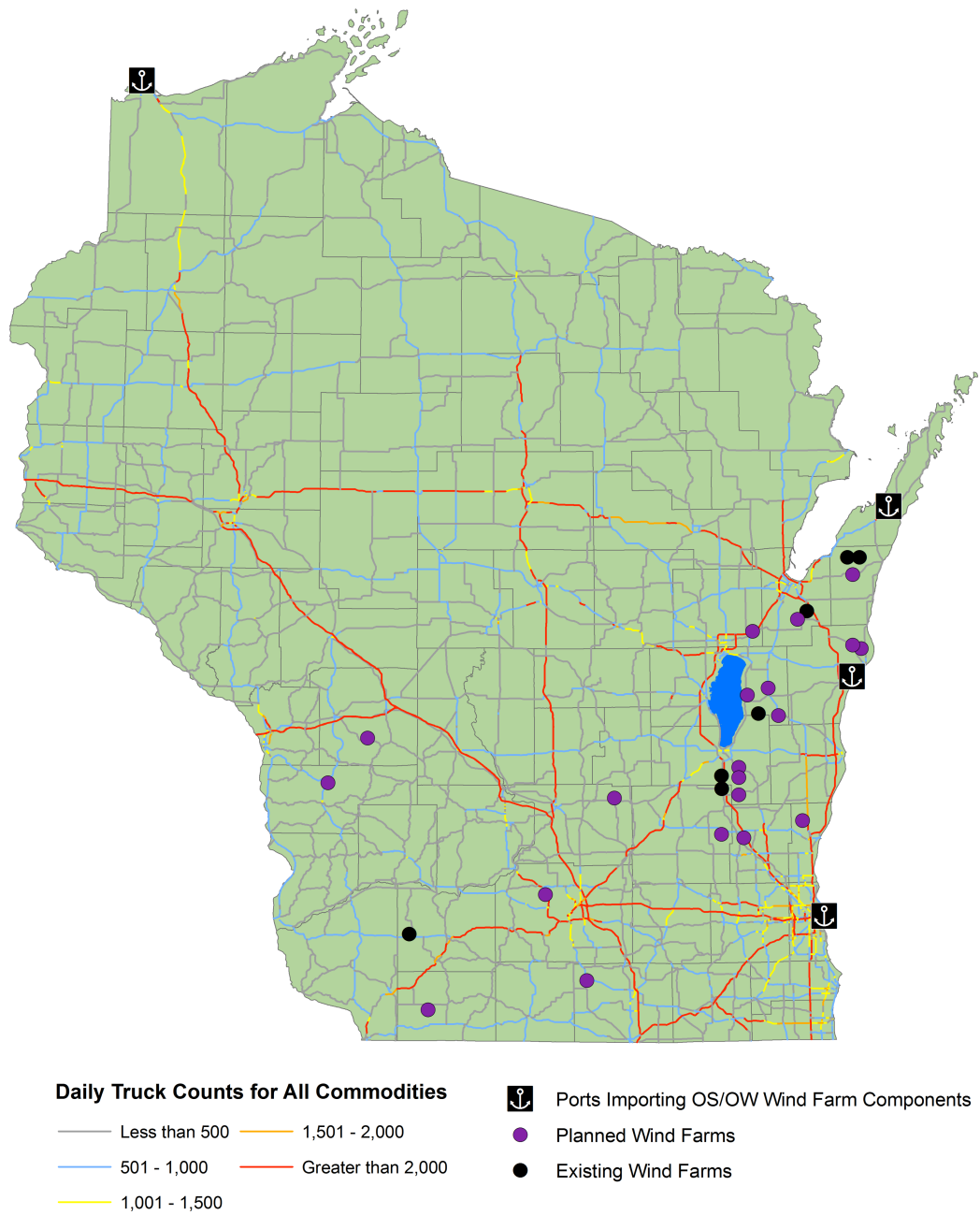

Source: RENEW Wisconsin, November 14, 2008.

## 4.7 CONCLUSIONS

Increasing transportation costs, especially with respect to increased diesel prices, multimodal capacity constraints, international competition, changes in rail services, and a shift to containerized shipments are driving businesses to seek additional productivity gains from the freight transportation system in the State of Wisconsin. This setting is further complicated by driver and equipment shortages and changes in the overall economic picture.

The agricultural, paper, foundry, forestry, and manufacturing industries of Wisconsin are especially vulnerable to regional and international competition. These industries are also currently weight constrained in truck movements. Many of the industries, most notably sand and gravel shipments are very low value but require significant tonnage on the roadway network. Overall, these and other industries could realize economic benefits from modified weight restrictions.



## 5.0 Wisconsin Large Truck Crash Trends

### 5.1 SUMMARY

This section focuses on large truck crashes data at the State and the national level, and provides a safety context for consideration of modification of Wisconsin truck size and weight regulations. A comparison of large truck crash numbers and rates in Wisconsin to that of the entire country is essential to better understand the State's record of large truck safety. Examination of the rates and trends of large truck crashes suggests how the State is likely to fare in the future if no changes are made to current regulations as well as whether the improvements in truck safety being achieved in Wisconsin are comparable to those of the nation as a whole.

Nationally, as well as in the State of Wisconsin, the number of large truck crashes and fatalities and the rate of large truck crashes and fatalities is trending downward while large truck vehicle mileage continues to increase.

Nationally, large truck crash rates dropped 25 percent to 172 crashes per 100 million vehicle miles of large truck travel (VMT) between 1997 and 2006. Large truck crash rates (for vehicles exceeding 10,000 pounds) in Wisconsin have declined by roughly 40 percent over the past decade. The estimated 2007 large truck crash rate is 129, significantly lower than the national average.

While there have also been decreases in large truck crashes in Wisconsin, there remain significant differences in large truck crash rates when examined at the county level. In 2006, the highest numbers of large truck crashes occurred in the counties that include the large urbanized areas of Milwaukee, Madison, Green Bay and Oshkosh, reflecting the high levels of truck travel that occur in those areas.

The highest rates of large truck crashes are more dispersed and occur in rural as well as urbanized counties. In addition to Milwaukee County, the counties that are experiencing higher large truck crash rates include rural counties of Menominee, Calumet, Taylor, and Adams.

### 5.2 METHODOLOGY

National level truck crash data was obtained from documents published by the U.S. Department of Transportation and are cited in the corresponding table or figure. Historical information regarding large truck crashes and crash rates in Wisconsin was obtained from the State of Wisconsin. The state produces Traffic Crash Facts annually and, unless otherwise noted, state statistics were obtained from those reports.

As both methods are useful, traffic crash information is presented here both in total occurrences of crashes and in crash rates (crashes per 100 million vehicle miles of travel). When considering total incidents, the observer has a clear impression of the overall scale of the situation. When presented as crash rates, the observer is better able to compare the experience on one roadway to the experience on another roadway when the two roadways carry different volumes, speeds, and patterns of traffic.

## 5.3 FINDINGS

### United States Crash Trends

In the United States, in 2006, there were 384,732 crashes involving large trucks.<sup>58</sup> Large trucks are defined as those with a gross vehicle weight rating of greater than 10,000 pounds. The total includes 4,732 crashes with fatalities, 80,000 crashes with personal injuries, and 300,000 crashes with property-damage-only. The national heavy truck crash rate in 2006 was 172.12 crashes per 100 million vehicle miles of heavy truck travel (MVMT).

The historical national crash rate for large trucks has declined in the period from 1997 to 2006, as shown in Figure 5.1.

**Figure 5.1 U.S. Large Truck Crash Rate Trends**

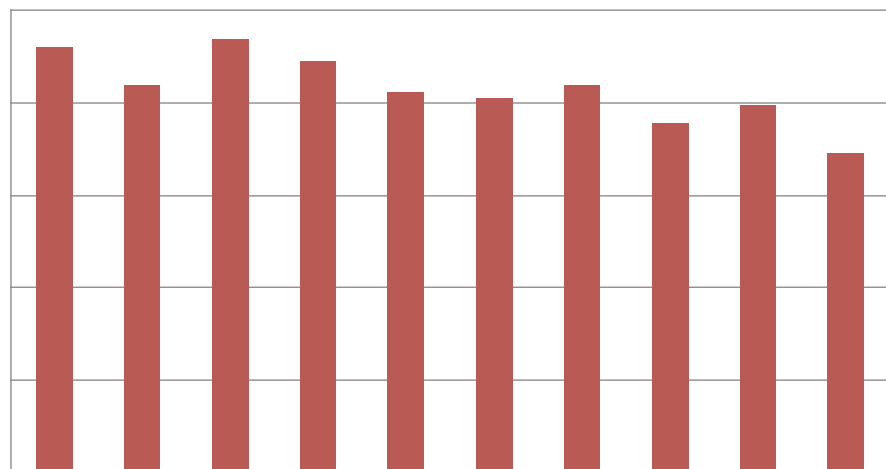

Source: Traffic Safety Facts, NHTSA's National Center for Statistics and Analysis.

<sup>58</sup>Traffic Safety Facts 2006, National Highway Traffic Safety Administration, National Center for Statistics and Analysis, U.S. Department of Transportation, Washington, D.C. 20590.



Crash rates for passenger cars and light trucks have also improved, while the crash rates for motorcycles have increased during the same period, as can be seen in Figure 5.2.

**Figure 5.2 U.S. Passenger Car, Light Truck, and Motorcycle Crash Rate Trends**

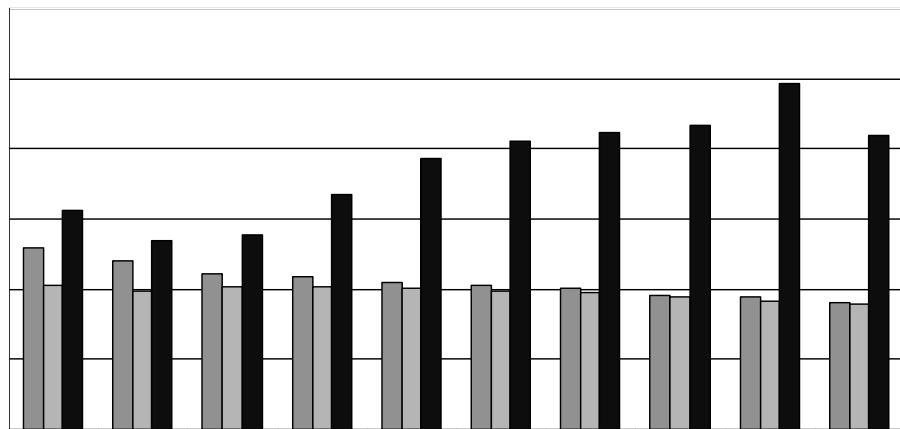

Source: Traffic Safety Facts, NHTSA’s National Center for Statistics and Analysis.

## Wisconsin Crash Trends

### *Statewide Trends*

Crashes in Wisconsin follow a similar pattern to crash patterns at the national level. From 1997 through 2006, total crashes in the State have decreased by 10 percent from 129,954 to 117,877. The number of total fatalities in the State has been in the range of 709 to 836 during this period. While there is an upward trend in the number of fatalities, the number of fatalities that occurred in 2006 was the lowest since 1998. Additionally, during the same period, overall travel in the State increased by 13 percent, from 53.7 billion VMT to 59.4 billion VMT (see Table 5.1).

**Table 5.1 Wisconsin Total Crashes, Fatalities and VMT  
1996 to 2006**

Year	Fatal Crashes	Fatal Crash Rate	Total Crashes	Total Crash Rate	Annual VMT (Millions)
1997	631	1.17	129,954	241.87	53,729
1998	628	1.12	125,831	224.51	56,048
1999	674	1.18	130,950	229.90	56,960
2000	718	1.25	139,510	243.62	57,266
2001	684	1.19	125,403	218.98	57,266
2002	723	1.23	129,072	219.72	58,745
2003	748	1.25	131,191	220.06	59,617
2004	714	1.18	128,308	212.44	60,398
2005	700	1.17	125,174	208.56	60,018
2006	659	1.11	117,877	198.44	59,401

Source: Wisconsin Crash Facts, 2006.

The combination of a decrease in the number of crashes and a leveling of the number of fatalities, with an increase in overall travel within the State results in a decline in the rate of crashes and fatalities during the period.

Large truck crash rates (for vehicles exceeding 10,000 pounds) in Wisconsin have declined by roughly 40 percent over the past decade. The estimated 2007 large truck crash rate is 129. This is significantly lower than the national average of 172.

Large truck crashes statewide in Wisconsin between 1999 and 2006 period declined by 19 percent, from 9,146 to 7,431, as shown in Figure 5.3.

**Figure 5.3 Wisconsin Large Truck Crashes**

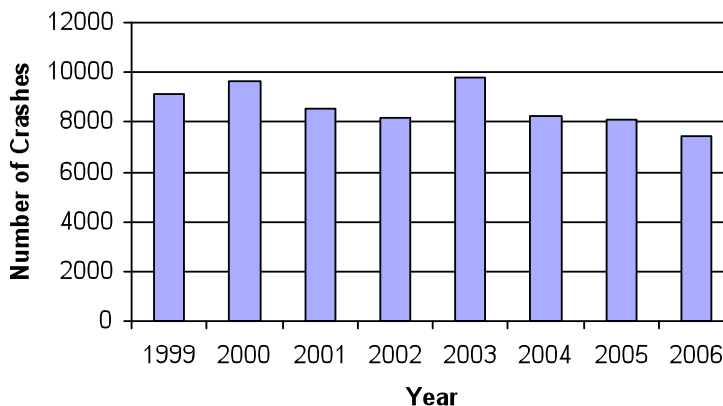

Source: Wisconsin Crash Facts, 2006.

### Wisconsin Crash Rates by Vehicle Type

Using crash records from the WisDOT Bureau of Transportation Safety (BOTS), Figure 5.4 shows the relationship between large truck crash rates in Wisconsin (large truck crashes per 100M large truck VMT), trucks hauling two trailers or “doubles” (doubles crashes per 100M doubles VMT), and all other vehicles (all other vehicle crashes per 100M other vehicle VMT). Crash rates for other vehicles are significantly higher than the crash rates for large trucks and doubles. There are many factors which may contribute to the lower values for large trucks and doubles. Commercial vehicles are more frequently operated on Interstates and other expressways as opposed to local roads which typically have higher crash rates. Also, commercial vehicles are often involved in long haul traveling with minimal lane shifts or turning movements. In addition, commercial drivers license holders have more training and experience than most drivers.

**Figure 5.4 Wisconsin Crash Rates by Vehicle Type**  
1984 to 2007

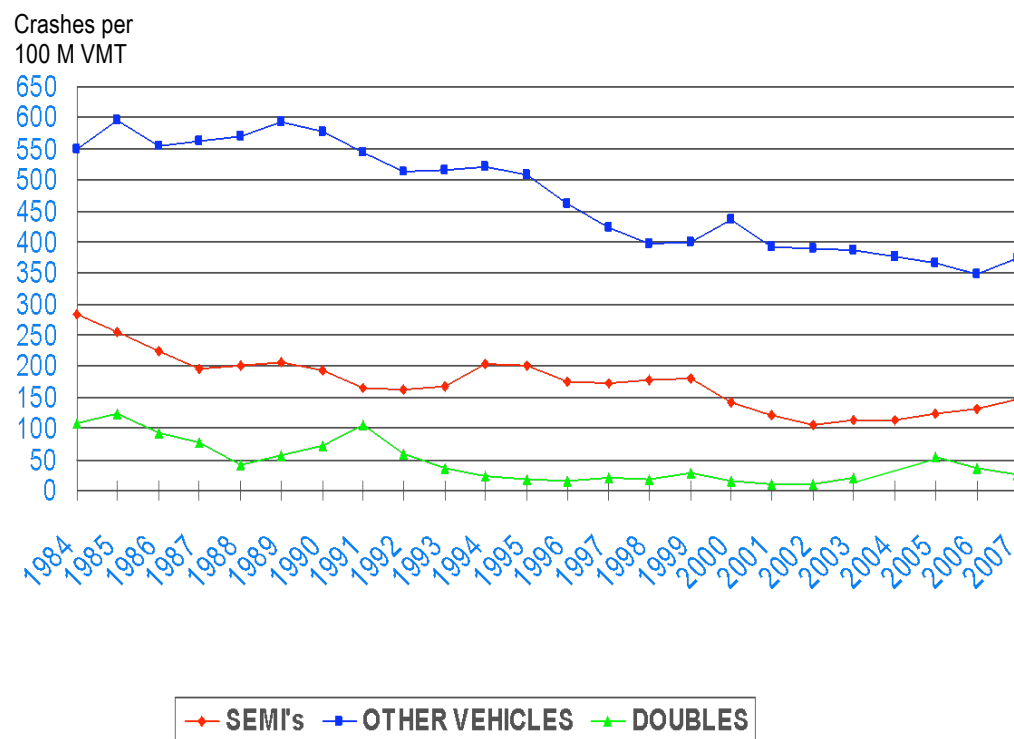

Source: Wisconsin Bureau of Transportation Safety.

Another important factor for comparison by vehicle type is fatal crash rates. Figure 5.5 shows the comparison between large truck (which includes doubles) fatal crash rates (crashes involving a fatality per 100 M large truck VMT) and all other vehicle fatal crash rates. As can be seen, large trucks have historically had a higher fatal crash rate. However, the gap between large trucks and all other vehicles has closed considerably. In the State of Wisconsin, large trucks have had a slightly lower fatal crash rate for the past seven years.

**Figure 5.5 Wisconsin Fatal Crash Rates by Vehicle Type  
1984 to 2007**

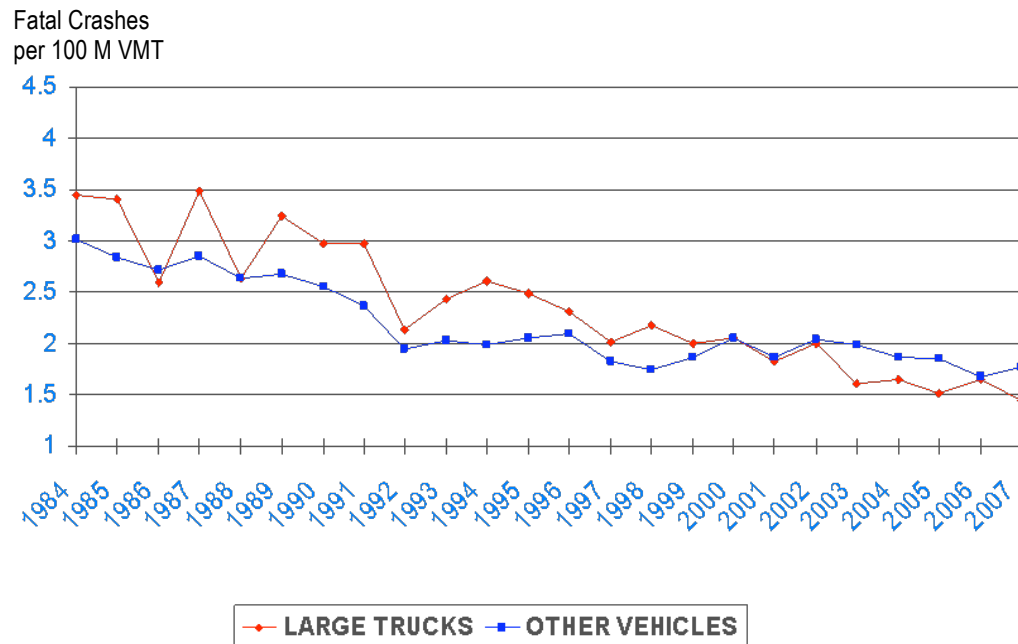

Source: Wisconsin Bureau of Transportation Safety.

### Crashes by County

Records of the number of large truck crashes in each county are maintained by WisDOT and shown in Figure 5.6. The largest numbers of crashes occurred in counties that are more intensively developed, including the Milwaukee, Madison, Green Bay and Wausau metropolitan areas. The lowest numbers of crashes occur in the more rural areas of the State.

**Figure 5.6 Large Truck Crashes by County  
2006**

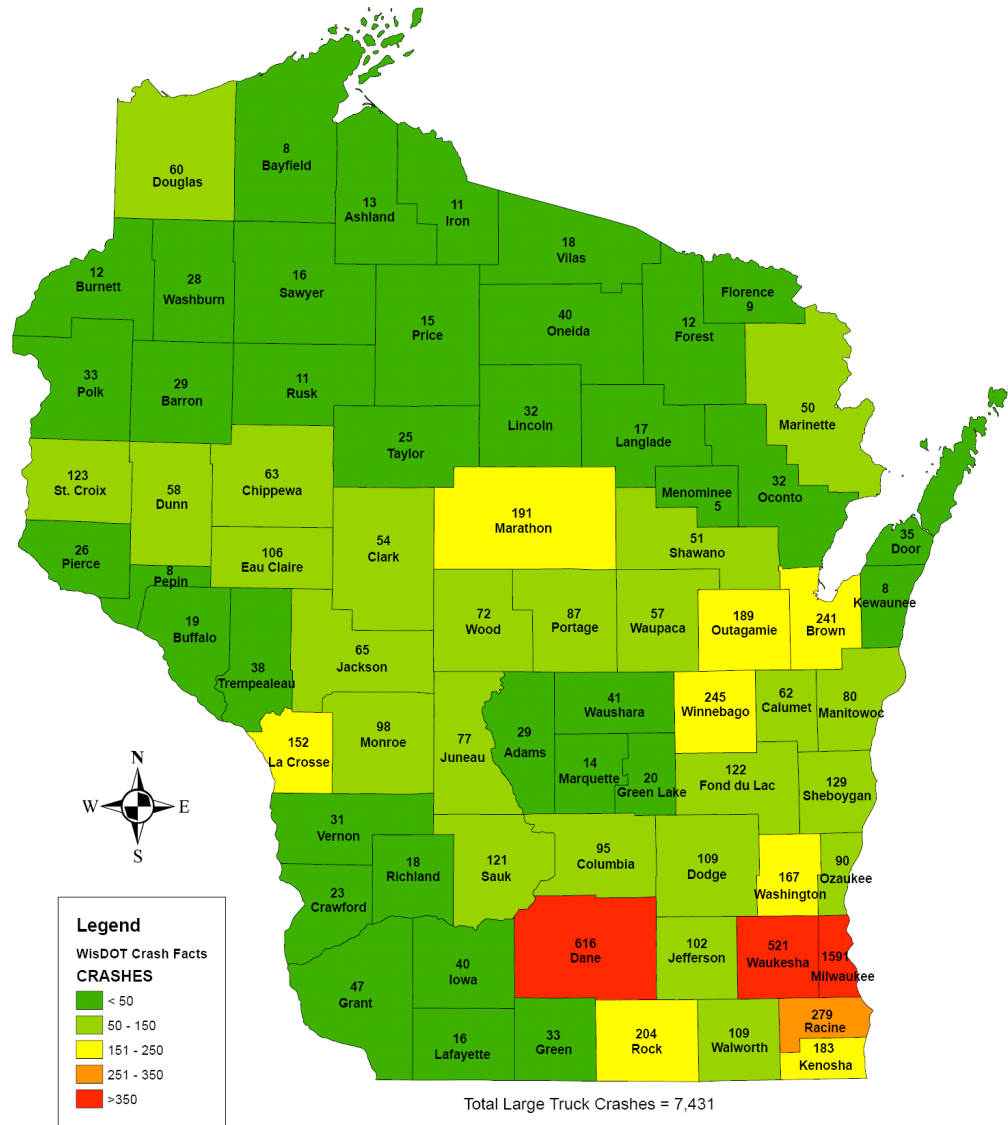

Source: Wisconsin Crash Facts, 2006.

Another useful way of considering crash statistics is an examination of crash rates, which, when examining a specific vehicle type, is given in terms of crashes per 100 million vehicle miles of travel by the specific vehicle type. A crash rate for a given area is determined by two factors, the number of crashes that occur in a given area and the amount of travel that occurs in that same area. Therefore, crash rates reflect the number of vehicle crashes given the actual number of roadway miles traveled by that vehicle type. A change in either factor will directly affect the crash rate.

WisDOT's Bureau of Transportation Safety estimates the large truck crash rate in 2006 to be 143. A record of the volume of truck vehicle miles traveled by county is not maintained. However, the Department of Transportation measures traffic volumes on all roadways in its system on a three-year rotating schedule. This information, along with an estimate of total statewide travel by WisDOT, makes a reasonable estimate of large truck vehicular travel by county possible.

Large truck crash rates for each county are given in Figure 5.7. The pattern of low crash rates and high crash rates by county is significantly different than the pattern of low and high numbers of crashes in Figure 5.6.

The counties experiencing large truck crash rates in 2006 include Milwaukee, which is a heavily urbanized area, and Taylor, Adams, Menominee and Calumet, which are much less intensely developed.

**Figure 5.7 Large Truck Crash Rates by County  
2006**

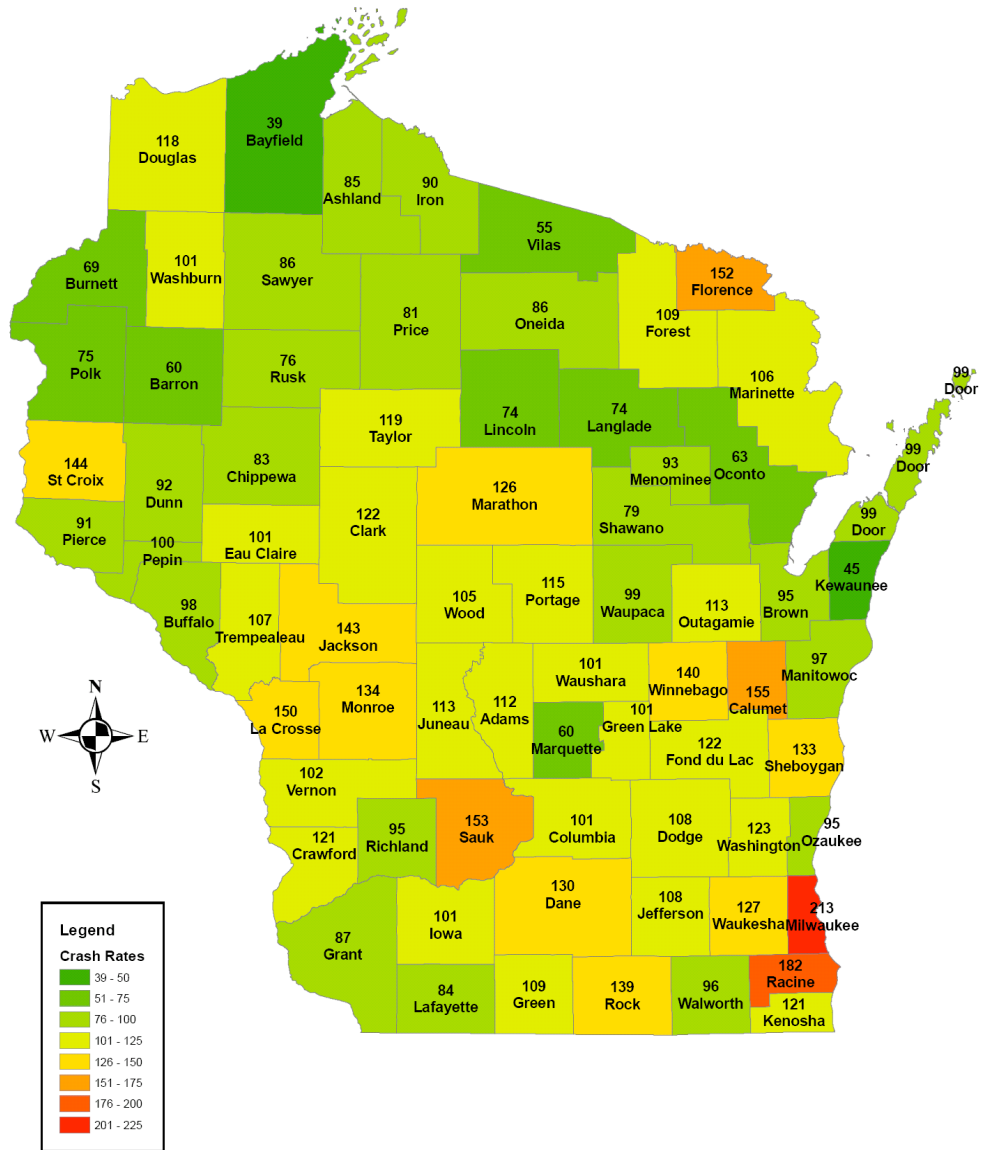

Source: Wisconsin Crash Facts and Wisconsin Bureau of Traffic Safety.





# 6.0 Potential Changes to TSW Laws and Practices

## 6.1 SUMMARY

The primary purpose of this study is to identify and evaluate potential changes to Wisconsin's truck size and weight laws. This section presents a range of potential changes based on the investigation of the study team – developed through an extensive public agency and private stakeholder outreach program and through research on existing Wisconsin laws and those of neighboring states. The result of these efforts is a set of six potential configurations for evaluation and several potential policy and organizational actions for consideration by the WisDOT and the Wisconsin Legislature.

## 6.2 CONFIGURATIONS FOR REVIEW

The study outreach and research identified six potential configurations for consideration by the State. These configurations were influenced by several factors, including:

- Outreach interviews with private stakeholders which suggested or endorsed configurations and operational parameters, such as the need for harmonization between Upper Great Lakes states;
- Given Wisconsin's long, shared border and close economic ties with Minnesota, the configurations include recently enacted changes to Minnesota's truck size and weight laws which allow several configurations on a permit basis; and
- Existing configurations available by permit or exception, including the six-axle 98,000 configuration available to the timber industry in Wisconsin but considered here for more broad application across industries.

Additional factors influenced the selection and narrowing down of the configurations for review, including the guidance of several advisory bodies to this study: the Trucking Issues Working Group; Study Advisory Group; and Peer Review Panel.

**Table 6.1 Six-Axle 90,000 Pound Semi**

Characteristics	
Requirements	Meet bridge formula, axle, and tire weight limits, Max. trailer length of 53 feet
Legal Status	Currently exceeds GVW limits (some exceptions apply)
Operation	Considered for operation with permit on Class A Highways (non-Interstate), Class B if determined acceptable by Permit Office, may be additional safety requirements
Pros	Increase to the same load-specific upper weight limit already permitted for five-axle trucks hauling raw forest products, fruits or vegetable may boost the prospect of policy-maker/public acceptance The six-axle configuration helps mitigate pavement damage.
Cons	Potential for heavy-truck traffic on lower-function State, county and town highways

**Figure 6.1 Axle Spacings and Weights**

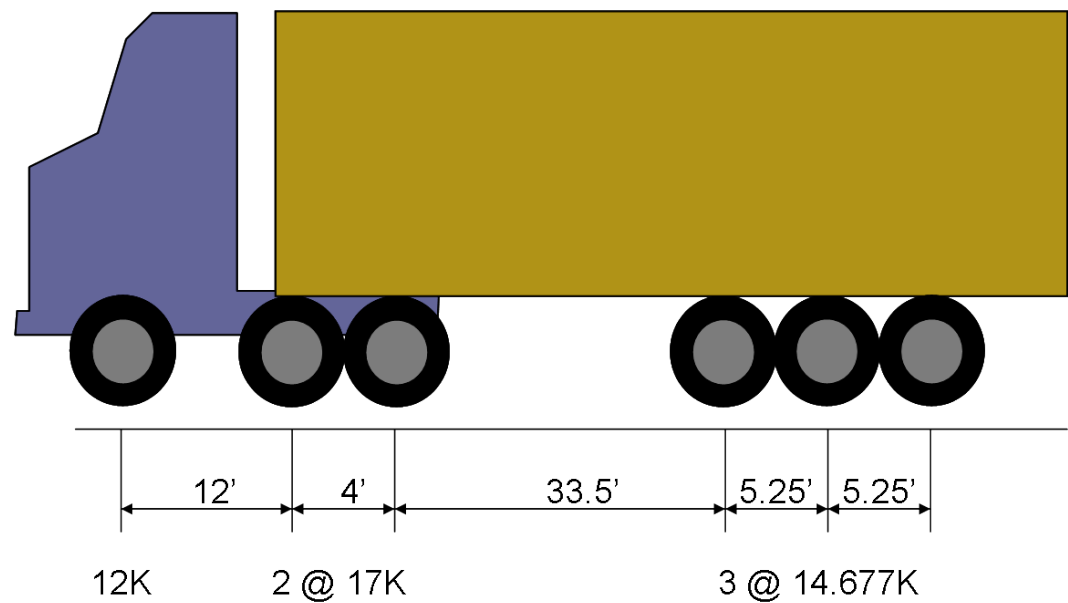

**Table 6.2 Seven-Axle 97,000 Pound Semi**

Characteristics	
Requirements	Meet bridge formula, axle, and tire weight limits, Max. trailer length of 53 feet
Legal Status	Currently exceeds GVW limits (some exceptions apply)
Operation	Considered for operation with permit on Class A Highways (non-Interstates), Class B if determined acceptable by Permit Office, may be additional safety requirements
Pros	Increase to the load-specific upper weight limit less than the 98,000-pound figure already permitted seasonally for six-axle trucks hauling lumber, salt and abrasives may boost the prospect of policy-maker/public acceptance The seven-axle configuration helps mitigate pavement damage
Cons	Potential for heavy-truck traffic on lower-function State, county and town highways More costly to industry to reconfigure both tractor and trailer

**Figure 6.2 Axle Spacings and Weights**

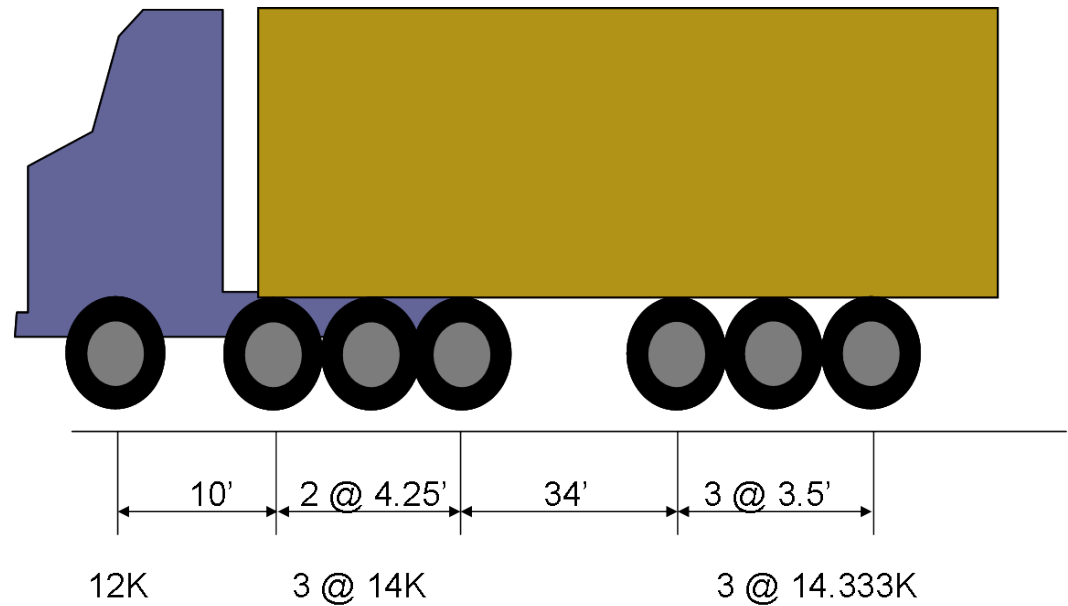

**Table 6.3 Seven-Axle 80,000 Pound Single-Unit (45-foot length)**

Characteristics	
Requirements	Meet bridge formula, axle, and tire weight limits, Max. vehicle length of 45 feet
Legal Status	Currently exceeds length for single-unit vehicles (40 feet)
Operation	Considered for operation with permit on Class A Highways including Interstate/NN, Class B if determined acceptable by Permit Office, may be additional safety requirements
Pros	This common 80,000 pound limit is unlikely to raise public opposition Operable on the Interstate/NN system
Cons	Potential for damage to bridges Some concern about dynamic performance

**Figure 6.3 Axle Spacings and Weights**

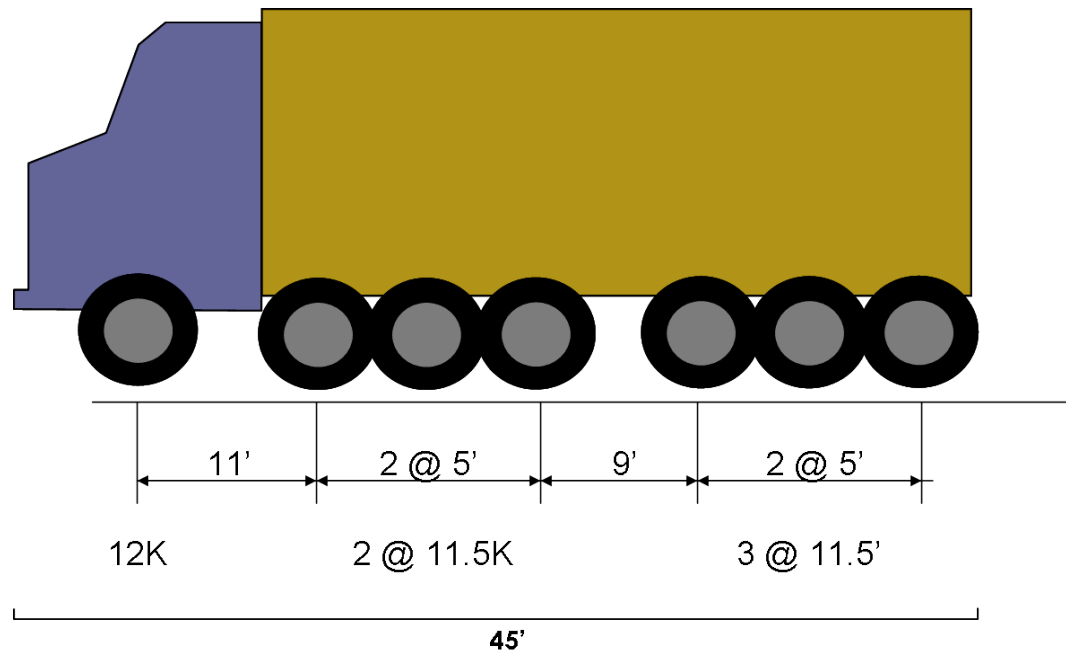

**Table 6.4 Eight-Axle 108,000 Pound Twin**

Characteristics	
Requirements	Meet bridge formula, axle, and tire weight limits, Max. trailer length of 28.5 feet each
Legal Status	Currently exceeds GVW limits and length limits on roadways which are not Designated Long Truck Routes or 75-foot Restricted Truck Routes
Operation	Considered for operation with permit on Class A Highways (non-Interstates) that are Designated Long Truck Routes or 75-foot Restricted Truck Routes, Class B if determined acceptable by Permit Office, may be additional safety requirements
Pros	<p>Lack of length increase may help mitigate public concern about this change on a double-bottom configuration</p> <p>The eight-axle configuration helps mitigate pavement damage.</p> <p>B-dolly configuration improves safety compared to existing doubles</p> <p>Proposed weight limit for this configuration still significantly lower than the highest weight limits in Iowa, Michigan and Indiana, which allow LCVs</p>
Cons	<p>Weight limit significantly higher than any other such commercial vehicle weight limit currently in place in Wisconsin and potential target for opposition</p> <p>Public more sensitive to a weight increase for double-bottom rigs than for single-trailer or straight-truck configurations</p>

**Figure 6.4 Axle Spacings and Weights**

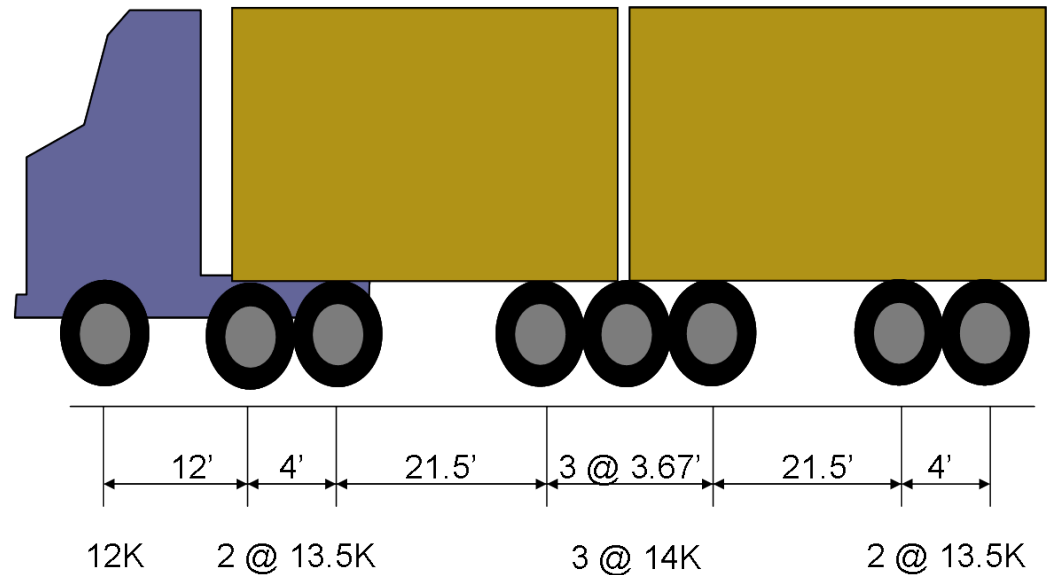

**Table 6.5 Six-Axle 98,000 Pound Semi**

Characteristics	
Requirements	Meet bridge formula, axle, and tire weight limits (excepting rear tridem, which exceeds weight limit), Max. trailer length of 53 feet. (The configuration as analyzed does not satisfy the Federal Bridge Formula.)
Legal Status	Currently exceeds GVW, axle weight, and tire weight standards, (permits available for certain loads)
Operation	Considered for operation with permit on Class A Highways (non-Interstate), Class B if determined acceptable by Permit Office, may be additional safety requirements
Pros	Matches existing allowable configuration by permit for loads of raw forest products Configuration reflective of a national effort by the American Trucking Association and others for 6-axle 97,000 pound vehicles and may therefore be applied to multiple states in the future
Cons	Potential for damage to pavement and bridges

**Figure 6.5 Axle Spacings and Weights**

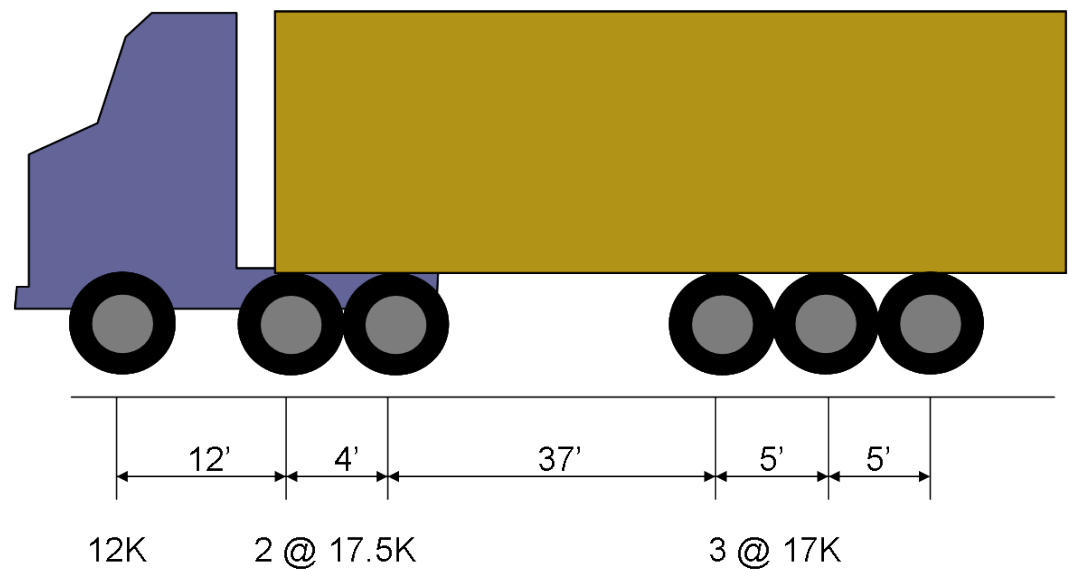

**Table 6.6 Six-Axle 98,000-Pound Straight Truck plus Pup Trailer**

Characteristics	
Requirements	Meet bridge formula, axle, and tire weight limits (The configuration as analyzed does not satisfy the Federal Bridge Formula.)
Legal Status	Currently exceeds GVW, axle weight, and tire weight standards (permits available for certain loads)
Operation	Considered for operation with permit on Class A Highways (non-Interstates), Class B if determined acceptable by Permit Office, may be additional safety requirements
Pros	Currently in operation by raw forest product haulers
Cons	Potential for damage to bridges

**Figure 6.6 Axle Spacings and Weights**

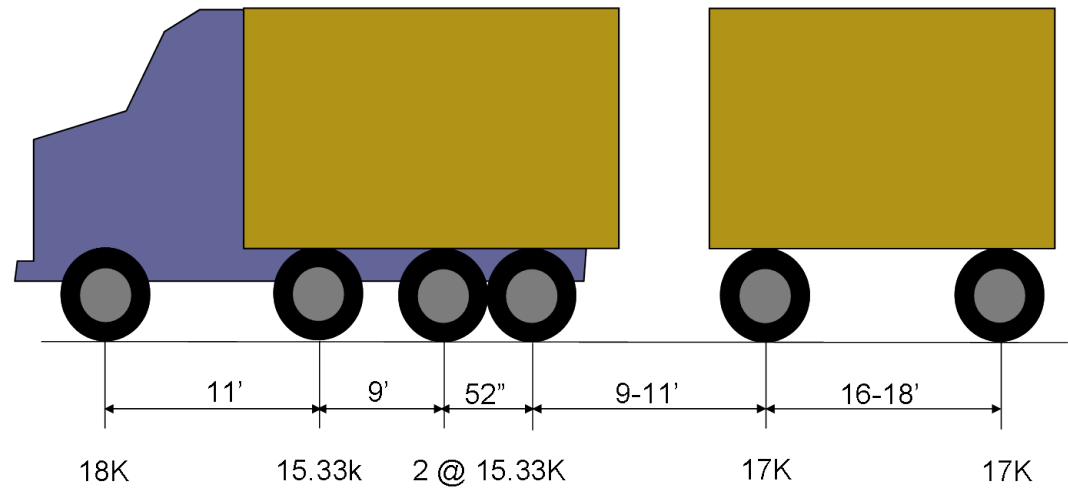

## 6.3 POTENTIAL POLICY RECOMMENDATIONS

During the course of the study research and outreach, several potential policy-based changes to truck size and weight laws and regulations emerged for consideration by the State. These policy actions are not part of the analysis framework of the study, which focused on the configuration-based changes, and are provided for information and future evaluation.

- **Administer performance-based permit program.** Outreach participants, including those engaged through the Safety Workshop, suggested that any changes in TSW should be implemented and administered through a performance-based permit system. This system would allow new configurations – such as those listed above – but would require a continued record of goods standing or compliance from the carriers using the new configurations. The record of good standing might include such performance measures as:
  - The consistent achievement of safety performance;
  - Certification of additional driver training or experience in order to operate the new trucks; or
  - Continued compliance with allowable weights – validated through periodic inspections and/or paper audits of logs.

Canada offers a rich source of peer experience with performance-based standards for productive truck configurations that may provide further insight on the development of standards and measures for a Wisconsin system.

- **Develop a comprehensive truck crash study.** This study utilized available BOTS data to analyze truck crash trends statewide and by county, but additional research is needed to more definitively pinpoint the factors driving the trends. The study should also focus on crash rate differences between configurations, if possible.
- **Work with the Federal government to explore the potential for TSW changes on the Interstate System.** Given the recent discussion of truck size and weight changes for potential inclusion in the upcoming Federal surface transportation authorizing bill, the State examined the effects of TSW changes both on and off the Interstate system. The Interstate analysis, which does not represent an intention by the State to allow the new configurations on its Interstates, provides information on the potential benefits – which are significantly greater than TSW changes to the State and local systems exclusive of the Interstate. In the future, the State may want to work with Federal partners and AASHTO to define potential national TSW changes on the Interstate system, building on the analysis provided here. Stakeholders voiced nearly universal support for consideration of TSW changes to the Interstate, realizing the available cost savings and the ability of the Interstate system to accommodate heavier loads.
- **Review OS/OW permit process.** Applicants for oversize and overweight permits suggested that the State review permitting processes statewide (including local jurisdictions) to increase the speed of issuance of permits.



While this study offers some insight into OS/OW permitting practices, additional study may be required by the State to determine what programmatic changes could be made to enhance permit activities, including adaptation for changing load demands (e.g., wind tower shipments). Because Wisconsin's permit fees are below average for the region, the State might consider increasing fees to support permit program enhancement, increased enforcement resources, and other directly related activities.

- **Increase fines for commercial vehicle size/weight violations.** Research for this study on regional TSW enforcement found that Wisconsin's overweight/oversize fine structure is among the lowest among its Great Lake State peers. The State may want to adjust fines upward to discourage the "incentive for noncompliance" fostered by the currently low fines. (See Part A portion of this report for additional detail). Outreach participants – both public and private – strongly suggested that the State dedicate any new revenues from fines or permits to the infrastructure and programs (permitting, enforcement, etc.) directly related to highway freight transport.
- **Increase resources for TSW enforcement.** Compared to other states, Wisconsin's TSW enforcement resources – especially inspection personnel – are low compared to State routes miles. With any changes to TSW, additional resources may be required to ensure compliance and safety.
- **Review nonpermitted weight exceptions.** Currently several industries enjoy weight exceptions without permit requirements. These industries include dairy, forest products, septage, and livestock. Through the outreach activities of the study and through research into the way regional peer states treat exceptions, it is clear that Wisconsin has more industry-specific exceptions than other states. The suggestion of outreach participants is that the State pursue a more uniform policy that would potentially extend privileges across additional industries or standardize existing exceptions in a way that would not favor one industry over another.



# 7.0 Truck Size and Weight Impact Analysis Methodology

## 7.1 INTRODUCTION

Changes in truck size and weight laws can result in measurable impacts to a number of public policy categories including the economics of freight transportation, the condition of highway infrastructure, the amount of traffic congestion, the safety of the highway system, and the environmental consequences of goods movement. This section of the report outlines in detail the methodology used to estimate the impact of changes to Wisconsin truck size and weight laws across these public policy areas.

The first step in analyzing the effects of potential changes is the estimation of the response by the freight transportation industry to the liberalization of truck weight and dimension maximum limits. This analysis assumes at least a portion of the trucking industry would act on new legislation by retrofitting the existing truck/trailer fleet or by purchasing new equipment to increase truck unit weight and/or dimension. By altering the number and type of trucks on Wisconsin's highways, TSW changes produce both savings and costs which accrue to private industry, government agencies, and the general public. This section of the report describes the methodology used to identify the savings and costs across the following measurement categories:

- Truck usage;
- Goods movement costs;
- Pavements and bridge decks;
- Bridge reconstruction<sup>59</sup>, rehabilitation, and posting costs;
- Safety;
- Congestion; and
- Energy and the environment.

In describing the methodology, this document will refer to conditions under current truck size and weight limits as the "Base Case" and conditions under a proposed change in limits as the "Scenario."

---

<sup>59</sup>Reconstruction of the bridge inventory to meet heavy trucks and TSW loading is the major element of the methodology. Outcomes from rehabilitation and posting are less severe with a lower cost.

The methodology draws heavily upon past studies of truck size and weight limit changes by the Minnesota DOT, the U.S. DOT, and the Transportation Research Board.

## 7.2 TRUCK USAGE

The foundation step in the methodology to evaluate truck size and weight effects is to estimate the potential use of new configuration trucks on the Wisconsin highway system. To develop this estimate, we followed a 5-step process that takes into consideration the following:

- **Step 1** - Identify vehicle configurations allowed under the Scenario that are not allowed under the Base Case on different highway systems;
- **Step 2** - Consider possible shipper and carrier responses to the Scenario and specify the types of shipments to be analyzed;
- **Step 3** - For these shipments, specify Base Case and Scenario vehicles, loaded weights, empty weights, backhaul (empty/loaded ratios), and highway systems used;
- **Step 4** - Estimate the amount of payload that would shift to Scenario trucks; and
- **Step 5** - Calculate changes in vehicle miles of travel (VMT) by truck type and operating weight caused by the Scenario.

The principal shipper and carrier responses to changes in truck size and weight limits are changes in operating weights and the types of trucks used, in order to reduce the cost of moving a given amount of freight. The cost savings are associated with lower operating costs - including decreased labor and fuel costs. The result of the adoption of fewer but larger or heavier trucks is an overall decrease in VMT that produces savings for the highway system. In addition to the shift to fewer but larger/heavier trucks, TSW law changes have the potential to affect the viability of freight rail activity. To address that aspect, this methodology also considered the possibility that changes in limits might cause shifts from rail to truck, changes in the total amount of freight shipped, and shifts in highway systems used by trucks. To measure these potential shifts, the study team performed sensitivity analysis to investigate how different assumptions about the size of various shifts might affect the overall evaluation of a scenario.

The amount of truck VMT required per unit of payload is calculated as follows:

$$\text{Loaded Truck VMT/Payload Ton-Mile} = 1/(\text{Loaded Weight} - \text{Empty Weight})$$

$$\text{Empty Truck VMT/Payload Ton-Mile}$$

$$= (\text{Empty/Loaded Ratio})/(\text{Loaded Weight} - \text{Empty Weight})$$

where Loaded Weight and Empty Weight are in tons.

Empty/loaded ratios vary by type of truck and commodity carried. For specialized vehicles like cement mixers and grain hoppers, empty/loaded ratios

are typically 1.0, since a loaded trip usually involves an empty backhaul trip of the same length. For dry vans operating over long distances, empty/loaded ratios are much lower (0.2 is typical).

The primary sources for information on empty weights, and empty/loaded ratios are the U.S. Department of Transportation's Comprehensive Truck Size and Weight Study (2000), the American Transportation Research Institute's report on Energy and Emissions Impacts of Operating Higher Productivity Vehicles, and interviews with shippers and carriers in Wisconsin.

To guide estimates of the amount of freight that might shift to heavier trucks under each Scenario, the study team prepared tables showing the current distribution of truck traffic by truck type, operating weight, and highway system. In preparing these tables, the study team used data on truck volumes, classifications, and operating weights compiled by Wisconsin DOT for the Highway Performance Monitoring System (HPMS) and Vehicle Travel Information System (VTRIS).

With these distributions, the study team estimated the amount of Base Case freight (measured in payload ton-miles) moving in trucks that are at or close to Base Case weight limits. This weight-limited freight is a good candidate for shifting to heavier trucks if weight limits are increased.

Estimates of diversion from Base Case to Scenario configurations were developed for two cases:

1. **Non-Interstates Only.** Scenario configurations are not allowed on Interstate highways; and
2. **All Highways.** Scenario configurations are allowed on Interstate highways (this case would require a change in Federal truck size and weight regulations).

For the Non-Interstates Only case, it was estimated that 10 percent of the freight diverted from Base Case to Scenario trucks would involve a shift from Interstate to non-Interstate highways. Sensitivity analyses were performed assuming 0 percent and 20 percent shift from Interstates for this case.

## 7.3 GOODS MOVEMENT COSTS

In order to estimate the effect of the potential changes on private industry, the study team calculated the changes in goods movement costs resulting from each of the potential configurations. To measure this, we estimated the change in operating costs between the Base Case and Scenario trucks. The primary source for information on truck operating costs is the U.S. DOT's Comprehensive Truck Size and Weight Study (2000). The U.S. DOT Study provides truck operating costs by truck type and operating weight for the following cost components: drivers, vehicles, fuel, tires, repair, and overhead (see Table 8.2 for a detailed breakdown of transport cost results). Costs from that study were updated to 2008 dollars. Truck fuel consumption rates were also updated using data

from the Federal Highway Administration's *Highway Statistics*. Using this information, the study team obtained unit operating costs (\$/VMT) for Base Case and Scenario trucks at different operating weights and then calculated scenario cost savings using the unit costs and truck usage impacts.

## 7.4 PAVEMENTS AND BRIDGE DECKS

Engineers design roads to accommodate projected vehicle loads, in particular, heavy vehicle axle loads. The life of a pavement is related to the magnitude and frequency of these heavy axle loads. Pavement engineers use the concept of an equivalent single-axle load (ESAL) to measure the effects of heavy vehicles on pavements.<sup>60</sup> Any truck axle configuration and weight can be converted to this common unit of measure. Adding axles to a truck can greatly reduce the impact on pavement. A conventional five-axle tractor-semitrailer operating at 80,000 pounds gross vehicle weight (GVW) is equivalent to about 2.4 ESALs. If the weight of this vehicle were increased to 90,000 pounds (a 12.5 percent increase), its ESAL value goes up to 4.1 (a 70.8 percent increase), because pavement damage increases at a geometric rate with weight increases. However, a six-axle tractor-semitrailer at 90,000 pounds has an ESAL value of only 2.0, because its weight is distributed over six axles instead of five. An added pavement benefit of the 90,000-pound six-axle truck is that fewer trips are required to carry the same amount of payload, resulting in almost 30 percent fewer ESAL miles per payload ton-mile.

The methodology accounts for two broad categories of infrastructure impacts: surfaces and structures. To account for the impact on pavements and bridge decks, the study team utilized the following steps:

- **Step 1** - Estimate cost to highway agencies and other road users associated with an additional ESAL<sup>61</sup> mile of travel for various types of highways and highway conditions;
- **Step 2** - Estimate ESALs as a function of operating weight for Base Case and Scenario trucks;
- **Step 3** - Calculate the change in ESAL miles due to freight shifting from Base Case to Scenario trucks; and
- **Step 4** - Calculate the change in pavement and bridge deck costs as the product of 1) the change in ESAL miles and 2) cost per ESAL mile.

---

<sup>60</sup>One limitation of ESAL pavement analysis is that it may not fully capture the costs for pavements that have inadequate bases and subgrades, potentially resulting in understated cost estimates for impacts to lower volume local roads with inadequate pavement foundations.

<sup>61</sup>The equivalent single-axle load (ESAL) is used to measure the effects on pavements of different types of axles and axle weights. By convention, one ESAL is an 18,000 pound single axle.

Pavement impacts of scenarios were calculated under two different assumptions:

1. Pavement-related expenditures by highway agencies would be adjusted upward or downward so that the pavement conditions experienced by road users will not be affected by the Scenario; and
2. Agency costs for pavements will be the same under the Base Case and the Scenario, so that all pavement impacts are incident on road users.

The first assumption was used in the primary analysis. The second assumption was used in a sensitivity analysis.

Changes in ESALs affect agency cost for pavements and bridge decks primarily by increasing or decreasing the time to the next pavement resurfacing, pavement reconstruction, or deck replacement. Agency cost impacts were estimated using data on ESAL-miles by highway system compiled from Wisconsin VTRIS and HPMS data, average resurfacing costs per lane mile by highway type from the Federal Highway Administration's Highway Economic Requirements Model (HERS), bridge deck replacement costs, and information regarding average time between pavement resurfacings from HPMS.

The effect of ESALs on pavements is not constant throughout the year. During the winter, when the ground is frozen, a truck carrying a given load causes much less damage to pavements than at other times of the year. During the spring, the inverse is true: pavement layers are generally in a saturated, weakened state due to partial thaw conditions and trapped water, causing greater pavement damage by the same truck.

The pavement analysis also accounted for nontraffic-related pavement deterioration due to weather and other factors. These nonload-related factors are much more significant on local roads, which have lower heavy truck volumes and thus are subject to fewer ESALs per year.

Deteriorating pavements affect road users by increasing vehicle repair costs, fuel consumption, and ride discomfort (especially at higher speeds). The study team used relationships between pavement condition, vehicle speeds, and vehicle operating costs from FHWA's Highway Economic Requirements System (HERS) to estimate impacts on road users. These relationships are illustrated in Figure 7.1 for low-volume roads with speed limits of 40 and 60 miles per hour. The curve for 60 mph is below the curve for 40 mph because travel time is a major component of road user costs. Both curves slope downward, indicating that road user costs decrease with improvements in pavement condition. The 60 mph curve has a larger downward slope than the 40 mph curve indicating that pavement condition has more of an effect on road user costs on higher speed roads.

These relationships, together with assumptions about the total volume of traffic and ESALs on a highway, can be used to estimate the cost to other road users of an additional ESAL mile of travel.

**Figure 7.1 Effect of Pavement Condition on Road User Costs for Low-Volume Roads**

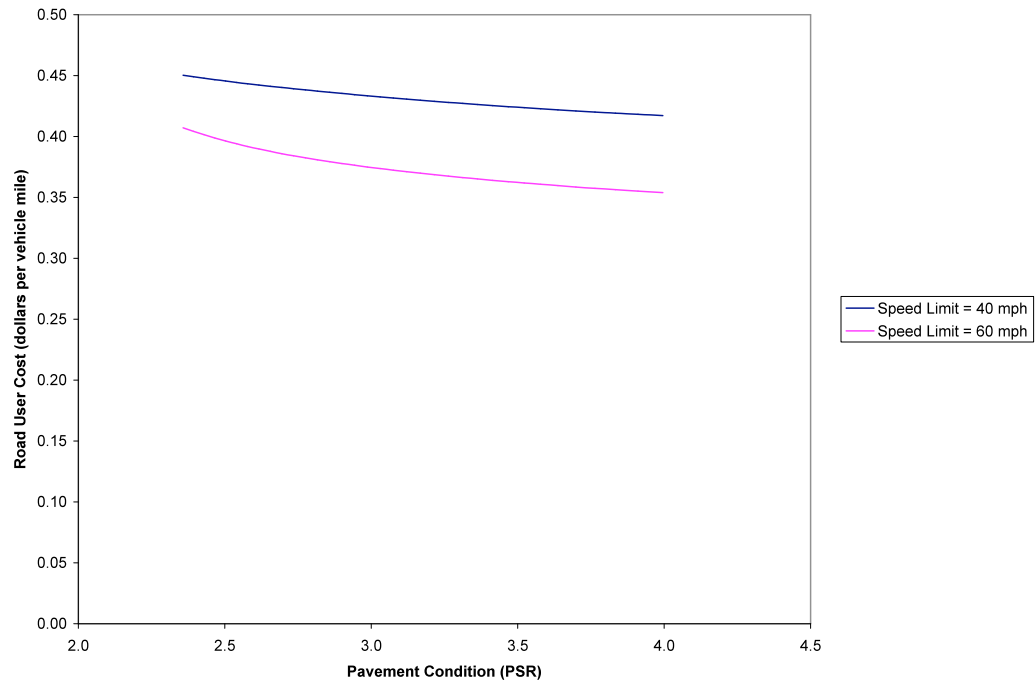

Source: Developed using travel time and vehicle operating cost models from FHWA’s Highway Economic Requirements System (HERS).

For example, consider a low-volume road with a 55 mph speed limit, annual average daily traffic of 2,000, and average ESALs per day of 200. Assume further that the road will be resurfaced at a fixed time interval. If ESALs on the road are increased, pavement condition will be worse at the time of resurfacing and road user costs over the life of the pavement will be higher. Using typical pavement deterioration curves and the cost relationships illustrated in Figure 1, we estimate that with a 10 percent increase in ESALs, average road user costs over the life of the pavement will increase by \$0.0022 per vehicle mile. With this information, the added cost to road users per ESAL mile can be calculated as follows:

$$2,000 \text{ AADT} * \$0.0022/\text{VMT}/20 \text{ more ESALs/day} = \$0.22 \text{ per added ESAL mile}$$

Using the approach illustrated above, the study team developed cent per ESAL mile values for different types of roads, varying speed limit, AADT, and ESALs per day.

In calculating ESALs as a function of operating weight, the study team used the ESAL values shown in Table 7.1, with the assumption that ESAL values for each type of axle group vary with the fourth power of axle weight.



**Table 7.1 Basis for Estimating Equivalent Single-Axle Load (ESAL) Factors**

Axle Configuration	Basic Load (pounds)	Flexible Equivalency Factor	Rigid Equivalency Factor
Single	18,000	1	1
Tandem	34,000	1.09	1.95
Tridem	48,000	1.03	2.55

Note: ESAL values for other weights are calculated based on the assumption that ESALS vary as the fourth power of axle weight.

Source: NCHRP Web Document 13; *Developing Measures of Effectiveness for Truck Weight Enforcement Activities: Final Report*; 1998.

## 7.5 BRIDGE RECONSTRUCTION, REHABILITATION, AND POSTING COSTS

The second infrastructure category impacted by TSW changes is structures. The purpose of this portion of the evaluation is to determine the ability of Wisconsin's bridges to accommodate the Base Case and Scenario trucks and to estimate the degree to which the TSW changes would require bridge reconstruction, rehabilitation/reinforcement, or posting. This analysis also identifies the costs associated with these bridge options. Rehabilitation procedures usually address an isolated deficiency that may correct a structural capacity issue or functionally obsolete element of the bridges. Overall cost to rehabilitate a specific bridge is less than total replacement cost. Posting a bridge restricts over weight or over width vehicles and eliminates this bridge and route to truck traffic. The direct costs associated with bridge posting is minor in comparison to associated costs of limiting the bridge and route from future truck traffic.

The Wisconsin inventory of highway structures exceeds 13,800 bridges according to the most recent information from the Bureau of Structures (BOS) and their Highway Structure Information System (HSIS). This vast inventory of bridges (clear span length greater than 20 feet) includes grade separation, stream crossing, and railroad structures under the jurisdiction of WisDOT as well as the local municipality (county, town, city, village, and railroad). These bridge type structures are located along the Interstate highway system, along the network of State trunk highways, and along the off-road system roadways of minor State routes, county, town, city, and village streets.

The FHWA defines a bridge as a structure with a clear span length from face to face of abutment equal to or greater than 20 feet. It is important to note that HSIS information only identifies structures with a clear span length equal to or in excess of 20 feet. There are many structures on the local road system with a configuration of a bridge but not considered under this TSW Study. There is no method to quantify these shorter structures to determine the relative construction cost to rehabilitate or replace. Typically, these smaller structures include concrete and metal culvert pipes, three sided concrete rigid frames,

short span concrete, timber, and steel beam structures. An extensive field review to locate and verify these structures is necessary to provide a meaningful cost evaluation.

This study classifies the State inventory of bridges into two general groups of structures. Group 1 includes those structures carrying Interstate and State trunk highways over various features. Group 2 includes those structures carrying State and local municipality highways over the Interstate and the State trunk system as well as all local bridges under the jurisdiction of the local municipality.

### **Bridge Rating Criteria**

Bridge rating criteria establish the thresholds for evaluating the ability of structures to accommodate the Base Case and Scenario trucks. The rating criteria have evolved over time in parallel with increased vehicle loads and the development of stronger structures. Because many Wisconsin bridges were developed with standards that pre-date today's requirements, it is important to understand some basic facts about current and past rating criteria.

The AASHTO rates a bridge on its ability to carry a vehicular load based upon a number of factors including but not limited to the design vehicle weight and span configuration. One of two AASHTO publications, the "Standard Specifications for Highway Bridges," 17<sup>th</sup> Edition, 2002 or the "LRFD Bridge Design Specifications," Fourth Edition, 2007, defines the design vehicle.

The "Standard Specifications for Highway Bridges" controlled bridge design criteria prior to 2008 using a standard vehicle classified as H or HS depending upon the number of axles or a train of trucks commonly called lane loading. A number would follow the H or HS and designate the gross weight in tons of the tractor truck (front two axles). The H vehicle contained two axles spaced 14 feet apart and considered a single truck. The HS vehicle contained three axles with the front two axles spaced 14 feet apart and the rear axle spacing varying from 14 feet to 30 feet. The HS loading designates a tractor-trailer configuration. The lane load consisted of a uniform load plus a single concentrated load. The gross weight of the standard vehicle (front two axles) would vary from 10 tons (H 10) to 50 tons (HS 25). The standard design vehicle is not common to any truck or tractor-trailer using Wisconsin roadways.

The H vehicle distributes 20 percent of the gross vehicle weight to the front axle and 80 percent to the rear axle. As an example, the standard H 15 vehicle has a front axle weight of 6,000 pounds and a rear axle weight of 24,000 pounds for a gross vehicle weight of 30,000 pounds.

The HS vehicle includes an additional 80 percent load to the third axle of the trailer. As an example, the standard HS 20 vehicle has a front axle weight of 8,000 pounds and a second and third axle weight of 32,000 pounds each for a gross vehicle weight of 72,000 pounds.

The lane load varies by the H or HS designation. Refer to the "Standard Specifications for Highway Bridges" for the actual configuration of the lane load.

AASHTO introduced the HS standard vehicle classification in 1944. For this reason, many of the older structures in Wisconsin have inadequate structural capacity to carry current loading configurations. This is particularly applicable to bridges under local jurisdiction control.

In general, State route bridges used a heavier standard design vehicle weight until about 1978 when all Wisconsin bridges converted to HS 20 as the standard design vehicle. Recently BOS guidelines used a HS 25 vehicle (90,000-pound gross vehicle weight) to simulate the new standard design vehicle under the “LRFD Bridge Design Specifications.” Structures designed for the HS 25 load are more capable of carrying heavier loads and overloads.

The “LRFD Bridge Design Specifications” uses a HL 93 design vehicle combining both a standard truck and lane load. Refer to the “LRFD Bridge Design Specifications” for the actual configuration of the design vehicle. Currently, only a small number of Wisconsin structures implement the new HL 93 vehicle configuration. In general, the HL 93 vehicle is more conservative than the old H or HS configuration. Structures designed for the HL 93 load are more capable of carrying heavier loads and overloads.

A structure designed under the “Standard Specifications for Highway Bridges” has less reserve capacity if evaluated under the “LRFD Bridge Design Specification.”

The design vehicle generates three additional ratings used to define the ability of a bridge to carry a specific vehicle load. These ratings include the inventory, operating, and maximum vehicle weight or rating factor. The span configuration is the geometrical layout of a bridge including the type of material, member spacing, and method of loading. The geometrical properties of the span configuration dictate the maximum weight or rating factor.

The current design vehicle under the AASHTO LRFD Bridge Design Specification is HL-93 as compared to the former HS-20 or HS-25 vehicle under the Standard Specifications and WisDOT Bridge Manual procedures, respectively. The HL-93 vehicle consists of a standard truck and standard lane. New design procedures also require the bridge to carry a Standard Permit Vehicle (SPV) with a minimum gross vehicle weight of 190,000 pounds while supporting a future wearing surface. These design requirements will allow new structures to carry the proposed TSW vehicle loads without posting restrictions. Therefore, improvements to bridge design methodology are minor because new bridges already include procedures to allow for the increased loading of TSW vehicles. Implementation of TSW loading has little or no effect on the overall design cost.

Implementation of increased TSW vehicle size may have a slight reduction in the service life of new structures because of fatigue loading. The increased load will cause a higher stress range between the maximum and minimum stress. This increased stress range will cause a minor reduction in the service life for new structures. However, use of the new design vehicle will minimize this reduction. Older structures will experience additional fatigue loading and potential

premature failure because the original design vehicle was smaller or fatigue loading not considered.

Older bridges designed for less than the HL-93 or HS-20 or HS-25 vehicle or not capable of carrying the SPV of 190,000-pound minimum may require some form of modification and/or posting to carry the larger TSW vehicles. A query of HSIS identified approximately 1,400 state and local load posted bridges. This list identifies bridges with structural as well as geometrical posting. Usually the maintaining agency posts a weight restriction for a specific vehicle configuration or a maximum vehicle weight on their bridge. A weight restriction is typical for a vast majority of the structures on the load posted bridge listing. Many of the local bridges have a narrow bridge posting and list a maximum vehicle weight of zero. Adequate rating information is lacking on those bridges without a maximum vehicle weight. These bridges will require verification of field data and specific rating computations and potential posting restrictions on a case-by-case basis.

## **FHWA Classifications**

The FHWA uses two additional descriptions to classify highway structures in less than desirable condition. The descriptions are “structurally deficient” and/or “functionally obsolete.”

### *Structurally Deficient*

A “structurally deficient” bridge is safe, but in need of costly repairs or replacement to bring it to current design standards. A structurally deficient bridge has at least one deteriorating structural component or deficiency causing either bridge closure or imposing vehicle weight restrictions. While not necessarily unsafe, these bridges may have limits for speed and weight. Structurally deficient bridges may not have adequate capacity to carrying the higher HS or HL vehicle.

### *Functionally Obsolete*

A “functionally obsolete” bridge has older design features, and while it is not unsafe for all vehicles, it may not adequately accommodate current traffic volumes, and vehicle sizes and weights. These restrictions are one contributing element to traffic congestion. They restrictions also pose such inconveniences as school buses, emergency vehicles, and heavy trucks taking lengthy detours. Both structurally deficient and functionally obsolete bridges may require posting or restrict modifications to Wisconsin truck laws.

Approximately 15 percent of Wisconsin bridges (2,070) are structurally deficient and/or functionally obsolete. More than 1,200 bridges are structurally deficient and not capable of carrying the legal load in Wisconsin. Since 2003, Wisconsin made steady progress in reducing the percentage of structurally deficient and functionally obsolete bridges. As a structurally deficient or functionally obsolete bridge is corrected, frequently another bridge needs to be added to the list. The

percentage of deficient structures remains relatively constant even with continued resources spent on this issue. However, there remains a significant demand to post, repair, rehabilitate, or replace deficient bridges as the bridge deficiency list grows on an annual basis.

A bridge's sufficiency rating (SR) prioritizes the bridge for rehabilitation or replacement funding under either the State route program or the Local Bridge Program. The SR ranges between 0 and 100. A bridge with a SR of zero is in poor condition and normally closed to traffic. A bridge with a SR of 100 meets the specific design criteria and has the capacity to carry the legal loads.

A bridge is eligible for replacement under the Federal Bridge Replacement Program if the SR is less than 50. A bridge is eligible for rehabilitation if the SR is between 50 and 80 and meets other requirements. WisDOT administers the State route program while the representative county, working with WisDOT, is responsible for administration of the Local Bridge Program. In general, the Local Bridge Program has structures that are more structurally deficient and functionally obsolete than the state maintained bridges. There are more local program bridges requiring replacement. The relative cost to replace a local program bridge is lower than a state maintained bridge.

The estimated annual construction cost for new bridges in the range of \$80 million to \$100 million from information available through the WisDOT Bureau of Structures web site and more specifically the section regarding "Structure Costs." This section provides a listing of structures bid through the department during a specific calendar year and including basic bridge configuration and overall cost. The cost data is for bridge-related bid items as shown on the structure plans. The listing includes both replacement type structures as well as those bridges as part of a major highway improvement project. The listing does not include minor rehabilitation projects or structures associated with the Marquette Interchange improvement. This latter data would skew the cost information. The total construction cost, including reconstruction of the approach roadway and other highway-related items is in the range of \$150 million to \$160 million annually.

Any change to the truck size and weight (TSW) laws will affect the structural capacity of a bridge and may cause other secondary impacts. Therefore, potential bridge impacts are an important consideration with regard to the evaluation of increased TSW.

## **TSW Impacts on Structures**

Increased TSW limits can affect the structural capacity of bridges by:

- Overstressing main load carrying members to the limit requiring the maintaining agency restrict the weight limit and post the bridge. This posting restriction may incorporate both the gross vehicle weight allowed to cross the bridge as well as speed of the vehicle. The intent of this study is not to evaluate a specific posting restriction but only identify the number of potential bridges requiring posting under special vehicle configurations.

Additional evaluation is necessary for specific bridges to identify the posting restriction based on actual bridge capacity or vehicle speed. Each special vehicle in the study will impart a different load on a specific bridge.

- The potential impact of TSW loads on those structures with a clear span less than 20 feet is significant and not reflected in this study and evaluation. Little is known about these structures and they will have an impact on other bridges. The shear magnitude of structures will have a significant impact on the implementation of the TSW loads.
- Premature member failure of the structure caused by increased fatigue or repetitive loading. Fatigue is the difference between the maximum and minimum stress in a particular member. A specific member has limited fatigue life with the application of repetitive loading. Heavier loads will cause higher differential stress resulting in fewer repetitive cycles prior to member failure. This study does not address a complete fatigue evaluation.
- Overload and illegal loads causing catastrophic failure of the entire structure. This study evaluated an estimate of the maximum gross vehicle weight allowed to cross a wide variety of structures. The study did not evaluate potential overload and illegal loads crossing specific bridges. State maintained bridges have adequate information stored in HSIS to compute the maximum gross vehicle weight a specific bridge carries. Locally maintained bridges require additional geometrical properties of the various members to determine the maximum gross vehicle weight. Structures with a clear span less than 20 feet will require a major field inventory, inspection, and rating program to address their condition prior to allowing increased loading.

The WisDOT BOS web site provides several documents to identify posted and restricted state and county-owned bridges. This information is time sensitive and a separate query of HSIS is more appropriate to identify any bridge restrictions. The information from HSIS is the most current data available and is used by WisDOT to monitor traffic restrictions.

Secondary affects may include the following:

- Increased agency costs for inspecting, rating, and posting bridges. The FHWA requires WisDOT and municipalities to inspect their bridges biennially (24-month cycle). The cost to inspect and rate a bridge varies by structure type and configuration. The actual cost to inspect, rate, and post a bridge is in the range of \$2,000 to \$3,000 per bridge. The major cost associated with bridge posting is user-related and other indirect costs caused by increased travel time and mileage. If a bridge is posted all truck configurations are restricted from using the structure.
- WisDOT performs biennial inspections on those state route bridges under their maintenance jurisdiction. This frequency of inspection will suffice for a majority of the state maintained bridges. Posted bridges may undergo a more frequent inspection to monitor the condition of critical members. Implementation of TSW loading may increase the inspection frequency of state maintained bridges in the range of 5 percent to 10 percent of those

bridges. For the basis of funding the study assumes about 400 state maintained bridges may require inspection and rating that is more frequent. This estimated additional cost of this inspection is approximately \$1.2 million per year.

- Outside agency pressure to replace deficient bridges to allow for increased TSW vehicles. Special interest groups and users may influence WisDOT and/or the local maintaining agency to modify bridges with less than desirable capacity to allow heavier vehicles to pass.
- Future bridge design may require an increased design load to match the axle loads and spacing of new TSW limits. A change in the design vehicle will have a significant negative impact on the cost of all new structures.

### *Federal Bridge Formula*

The FHWA Bridge Formula establishes the maximum weight any set of axles on a motor vehicle may carry and protects bridges against overstress. The formula specifies the maximum weight that can legally be carried on a group of contiguous axles, depending on the number of axles in the group and the distance from the first to the last axle. The formula is:

$$W = 500 * [L * N / (N - 1) + 12 * N + 36]$$

where W is the maximum weight of the axle group, L is the distance from the first to last axle in feet, and N is the number of axles. The Bridge Formula allows longer axle groups to carry heavier loads.

The stress on bridge members as a longer truck rolls across a bridge is much less than that caused by a short vehicle even though both trucks have the same gross weight and individual axle weights.

### **Structural Evaluation**

The team evaluated six truck configurations under the study to determine the vehicle impact on various types of structure configurations. The basic configuration of each vehicle follows:

- **Six-Axle Tractor-Trailer with 90,000-Pound Gross Vehicle Weight (6-90).** In its study configuration, this vehicle meets the Bridge Formula. The axle spacing is 12 feet, 4 feet, 33.5 feet, and two 2) spaces @ 5.25 feet. The axle load is 12,000-pounds, two 2) @ 17,000-pounds each, and three 3) @ 14,667-pounds each.
- **Six-Axle Tractor-Trailer with 98,000-Pound Gross Vehicle Weight (6-98).** In its study configuration, this overall vehicle does not meet the Federal Bridge Formula as the rear tridem exceeds allowable weight. The axle spacing is 12 feet, 4 feet, 37 feet, and two 2) spaces @ 5 feet. The axle load is 12,000-pounds, two 2) @ 17,500-pounds each, and three 3) at 17,000-pounds each.
- **Seven-Axle Tractor-Trailer with 97,000-Pound Gross Vehicle Weight (7-97).** In its study configuration, this vehicle meets the Bridge Formula. The axle

spacing is 10 feet, two 2) spaces @ 4.25 feet, 34 feet, and three 3) spaces @ 5.25 feet. The axle load is 12,000-pounds, three 3) @ 14,000-pounds, and three 3) @ 14,333-pounds.

- **Eight-Axle Tractor-Trailer with 108,000-Pound Gross Vehicle Weight (8-108).** In its study configuration, this vehicle meets the Bridge Formula. The axle spacing is 12 feet, 4 feet, 21.5 feet, two 2) @ 5.5 feet, 21.5 feet, and 4 feet. The axle load is 12,000-pounds, two 2) @ 13,500-pounds, three 3) @ 14,000-pounds, and two 2) @ 13,500-pounds. (This vehicle configuration is under future review by an outside agency.)
- **Seven-Axle Single Unit with 80,000-Pound Gross Vehicle Weight (7-80).** In its study configuration, this vehicle meets the Bridge Formula. The axle spacing is 11 feet, two 2) @ 5.5 feet, 9 feet, two 2) @ 5.5 feet. The axle load is 11,000-pounds, three 3) @ 11,500-pounds, and three 3) @ 11,500-pounds.
- **Six-Axle Tractor-Trailer and Pup with 98,000-Pound Gross Vehicle Weight (6-98 Pup).** In its study configuration, this overall vehicle does not meet the Federal Bridge Formula. The axle spacing is 11 feet, 9 feet, 4.5 feet, 11 feet, and 16 feet. The axle load is 18,000-pounds, 15,320-pounds, two 2) @ 15,330-pounds, 17,000-pounds, and 17,000-pounds.

The study team fine-tuned the axle spacing and axle weight to meet the restrictions and guidelines of the Federal Bridge Formula where possible. Even with this fine-tuning it was not possible for the 98,000-Pound vehicles to satisfy the Federal Bridge Formula.

The study team worked with the WisDOT, Bureau of Structures (BOS) to define the preliminary work tasks or steps for the bridge assessment and evaluation. The team developed a final technical approach addressing the structural analysis of various bridges to carry the special vehicle loads and configurations.

The following work tasks or steps were completed for the structural analysis stage:

### *Step 1*

The study team obtained bridge data from the WisDOT BOS. They accumulated bridge-related data from the Highway Structures Information System (HSIS) to produce a matrix of bridges on the Wisconsin State System. This phase of the evaluation was limited to State maintained bridges because the information is more reliable and the structural evaluation is easier to process.

The initial HSIS query identified 6,361 State maintained structures of various type and configuration, including slab bridges, pre-stressed girder bridges, structural steel bridge, specialty bridges, and culverts.

The initial query gathered the following information for each bridge:

- Length of maximum span;
- Operating rating;



- Type of vehicle or load model used to generate operating rating;
- Highway system and location of the bridge;
- Overall bridge length;
- Deck width;
- Bridge material, type (simple or continuous), and girder spacing;
- Average daily traffic;
- Average daily truck traffic;
- Detour length;
- Current posting restriction; and
- Other appropriate bridge data items to assist with the evaluation.

All of the above data items are available as part of the Federal Bridge Inventory. HSIS generated several reports to acquire this data and produce spreadsheets directly. The first three items are required to determine whether a specific bridge requires posting or replacement under different scenario loadings. The remaining items are required to determine posting and replacement costs. The study team produced several spreadsheets to evaluate various options to address the most appropriate method to query the structures.

### *Step 2*

The team sorted the bridges by structure configuration into the following primary load carrying member categories:

- Slab bridges (953 structures);
- Pre-stressed girder bridges (1,873 structures);
- Structural steel bridges (1,443 structures); and
- Other bridges (2,092 other type of structures, including culvert type bridges. The team eliminated culverts from further consideration and evaluation). Other bridges total 185 structures, excluding culvert type bridges.

### *Step 3*

This step developed a matrix for each category of structure configuration and sorted the bridge data based upon year built, simple or continuous span arrangement, maximum span length, comparison of design rating to maximum vehicle weight, and number of bridges in the category. Beam spacing for pre-stressed concrete girders and steel girder bridges were included in the data.

Each matrix of bridge configuration included 25 slab bridges, 25 pre-stressed girder bridges, 25 structural steel bridges, and 10 specialty bridges that include truss, through girder, floor system, and concrete T-beam structures. The 10 will specialty structures will include three truss bridges, four floor beam bridges, and three concrete T-beam structures.

BOS substituted several bridges and approved the selection of the 85 bridges in the study group by defined categories prior to the team proceeding with the additional structural evaluation. Unfortunately, this list included one duplicated structure and therefore the study group included only 84 bridges for further evaluation. The smaller study group has no affect on the evaluation stage. Refer to the following map showing the location of the bridge in the study group.

#### *Step 4*

The team evaluated each proposed truck configuration using the BOS SEP System. WisDOT uses SEP to evaluate and permit overweight vehicles for highway bridges. The study team ran the 84 bridges for each of the proposed truck configurations using the SEP results and recorded the Maximum Vehicle Weight allowed from the analysis. The SEP output assisted in determining whether a specific bridge required posting or replacement.

#### *Step 5*

Evaluate the SEP bridge analysis with an independent verification to validate the rating information. This evaluation is ongoing and will support both this study and continuing BOS activities. To accomplish this validation, the study team is evaluating a fixed number of bridges (up to 16) based on concrete slab, pre-stressed girder, and structural steel for typical span arrangements. Using the above matrix, the team is also analyzing 2 slab bridges, 2 pre-stressed girder bridges, 2 steel bridges, and 2 other type of bridges to verify, within a reasonable tolerance, the maximum vehicle weight produced by the SEP system. This independent evaluation is limited to State route bridges because locally maintained bridges are lacking plans or information in HSIS.

#### *Step 6*

The study team determined bridges that would have to be posted or replaced within the study group for each special vehicle configuration. Using the outcomes of the structural evaluation and the data acquired in step 1, the team estimated the number of bridges in the entire inventory that required posting or replacement based on each special vehicle configuration. The team also calculated order-of-magnitude costs for each proposed special vehicle configuration.

The team completed the following work tasks or steps for the bridge posting and replacement evaluation.

**Step 6.1** – Defined a “worst case” legal bridge loadings for each scenario.

**Step 6.2** – The team estimated the number of additional bridges requiring posting for each loading case but concluded this step will require additional evaluation on a bridge-by-bridge basis for a reasonable estimate. The use of replacement cost is more conservative and represents more realistic information.

**Step 6.3** – Estimated costs for bridge postings (including inspection and reinforcement). The actual cost to inspect, rate, and post a specific structure is

minor as compared to the cost associated with restricting traffic from using the bridge. The team estimated a cost in the range of \$2,000 to 3,000 per bridge to inspect, rate, and post. There are additional user costs associated with bridge posting, including increased travel time and mileage around the restricted structure.

**Step 6.4** – The team prepared several maps showing potential posted bridges for each special vehicle configuration to identify restricted routes, but as mentioned in Step 6.2, that particular map development will require additional evaluation.

**Step 6.5** – Identified bridges requiring replacement under each of the special vehicle loading configurations. Bridges for replacement were determined by correlating inventory ratings of bridges failing or near failure in the 84 bridge test group to all bridges on both the state and local systems. A minimum required inventory rating was set for each TSW vehicle for each structure type. Bridges with inventory ratings falling below the minimum required level were flagged as either needing replacement, rehabilitation, or posting. For cost estimating purposes it was assumed that all flagged bridges would be replaced.

**Step 6.6** – Estimated annualized agency costs for replacing bridges on State route and local route for each of the special vehicle configurations. The respective costs assume an estimated bridge deck area and average unit costs. All bridge replacement costs shown are in millions of dollars per year annualized over a 10-year period using a 5 percent interest rate.

**Table 7.2 Estimated Annual Bridge Replacement Costs**

Special Vehicle Configuration	State Route Bridge Replacement Costs	Local Route Bridge Replacement Cost
Six-Axle Tractor-Trailer, 90,000-Pound GVW (6-90)	\$0.04M	\$2.14M
Seven-Axle Tractor-Trailer, 97,000-Pound GVW (7-97)	\$0.28M	\$2.80M
Eight-Axle Tractor-Trailer, 108,000-Pound GVW (8-108)	\$0.04M	\$2.22M
Seven-Axle Single Unit, 80,000-Pound GVW (7-80)	\$0.78M	\$5.24M
Six-Axle Tractor-Trailer, 98,000-Pound GVW (6-98)	\$1.54M	\$6.94M
Six-Axle Tractor-Trailer and Pup, 98,000-Pound GVW (6-98 Pup)	\$0.72M	\$3.5M

The study team did not complete a detailed evaluation of the locally maintained bridges because HSIS does not include specific rating information. Instead, the team used the results of the State route evaluation to extrapolate replacement costs for local bridges. The review criteria included age, design rating, sufficiency rating, inventory rating, and type of structure. The replacement cost

used bridge area and unit prices to determine an order of magnitude cost to address bridges not capable of carrying the respective TSW special vehicle load.

It is important to note that **Table 7.2 does not account for the entire magnitude of the state and local bridge replacement cost.** The above cost only accounts for the bridge replacement cost associated with allowing the specific special vehicle across the bridge. The total cost to replace all statewide deficient bridges on both the state and local route far exceeds the amount shown above. Historically the Wisconsin bridge program replaces about 100 structures annually with an **estimated construction cost in the range of \$80 million to \$100 million (structure only cost).** The total construction cost including the bridge and approach roadway is in the range of \$150 million to \$160 million per year. This amount includes replacement of deficient bridges as well as bridge improvements to the state highway and local network of roads. The estimated total cost to repair or replace all deficient bridges, both state and local, is in the range of \$450 million to \$525 million. Over a 10-year period assuming 5 percent interest, the range of annual cost is \$58 million to \$68 million. Deficient state bridges account for approximately 25 percent of this cost while deficient local bridges account for the remaining 75 percent.

The team did not identify specific bridges requiring posting under each special vehicle configuration. The added cost associated with inspecting, rating, and posting a bridge is \$3,000 per structure. This inspection-related cost is an annual expense for a State route bridge. For a locally maintained bridge, the \$3,000 per structure is conservative. There is additional cost associated with posting a structure. These annual costs include additional mileage, additional time, and lost revenue of the user.

An exact number of bridges requiring posting is difficult to estimate. The team assumes 25 bridges require posting for the State route. Posting of locally maintained bridges is more likely because the bridge capacity is too low. Many local bridges are not structurally adequate to carry the legal load or the proposed TSW loading.

### *Step 7*

Developed a spreadsheet containing the above data for 85 bridges in the study group as well as those bridges not acceptable to carry the special vehicle configuration. These particular spreadsheets contain location and configuration information.

### *Step 8*

Determined bridge types that would require additional investigation. The team used HSIS and the results of the above work to determine the types of bridges that would require additional analysis. In general, State route bridge require no additional evaluation unless to validate the output of SEP. Any bridge locally maintained may require additional investigation because data within HSIS is somewhat suspect. Several other bridge types will require additional evaluation

and investigation because these structure types were excluded from the study. Additional evaluation is necessary for the following structure types:

- Timber;
- Reinforced concrete box culverts;
- Metal arch culverts;
- Reinforced Concrete Arches;
- Reinforced Concrete Rigid Frames;
- Steel Tied Arches;
- Steel Trapezoidal Box Beams;
- Bascule and Vertical Lift Bridges; and
- Specialty Structures.

## 7.6 SAFETY

The objective of the safety analysis is to identify the marginal safety risk associated with each of the proposed configuration changes to Wisconsin TSW laws. The safety analysis consist of two broad steps:

- **Step 1** - Estimate crash rates and unit costs by highway system, truck type, and operating weight; and
- **Step 2** - Apply crash rates and unit costs with estimated changes in truck traffic.

Average crash involvement rates by type of truck and highway system for 2007 were obtained from data compiled by WisDOT Bureau of Transportation Safety, Safety Policy Analysis Section. The following information from Transportation Research Board Special Reports 225 and 227 was used to adjust average crash rates for Base Case and scenario vehicles:

- There is a 0.25 percent increase in crash rates for each 1 percent increase in gross vehicle weight, other things being equal.
- Five axle double trailer trucks have fatal crash involvement rates about 10 percent greater than five-axle tractor semitrailers, when operated under the same conditions.
- Adding axles to a combination increases its braking ability, which in turn reduces crash rates. To account for this effect, it was assumed that increasing the number of axles by 20 percent (e.g., adding an axle to a five-axle combination) would reduce its crash rate by 5 percent.

Crash costs were estimating using *Unit Costs of Medium and Heavy Truck Crashes*, a Pacific Institute report prepared for the Federal Motor Carrier Safety Administration. The report provides estimates of the monetary losses associated

with crashes, as well as the nonmonetary losses due to shortened life, pain and suffering, physical impairment, etc.

The unit costs per medium- and heavy-truck crash from that study, updated for inflation to 2008, are shown in Table 7.3.

**Table 7.3 Unit Costs of Medium- and Heavy-Truck Crashes**  
2008 Dollars

Type of Crash	Monetary Losses Only	All Losses
Fatal	1,376,000	4,044,000
Injury	123,400	221,300
Property Damage Only	15,800	17,000

Source: Pacific Institute; *Unit Costs of Medium and Heavy Truck Crashes*; prepared for Federal Motor Carrier Safety Administration; 2006. Unit costs are updated for inflation to August 2008.

## 7.7 CONGESTION

The congestion analysis quantified the effect of truck VMT reduction resulting from the new configurations on Wisconsin highways. The team accomplished the congestion analysis through a three-step process:

- **Step 1** - Estimate added costs to road users associated with unit traffic volume increases by highway system;
- **Step 2** - Estimate passenger car equivalent<sup>62</sup> (PCE) factors as a function of truck type and operating weight; and
- **Step 3** - Estimate added costs to road users associated with predicted changes in truck traffic.

Congestion costs were estimated using the following information:

- Passenger car equivalents (PCE) by vehicle type and operating weight from an analysis of external costs performed as part of the 1997 Federal Highway (FHWA) Cost Allocation Study;
- Speed versus volume functions from the Highway Economic Requirements System (HERS) model to estimate added delay due to a unit increase in traffic volumes; and

---

<sup>62</sup>The passenger car equivalent (PCE) is a concept developed to measure the relative effects of different types of vehicles on speed and other traffic conditions. It converts a longer or heavier vehicle into an equivalent number of passenger cars. For example, if a truck has a PCE value of 2.0, adding that truck to the traffic stream would have the same effect on speeds as adding two passenger cars to the traffic stream.

- Wisconsin Highway Performance Monitoring System (HPMS) data to estimate current congestion levels by highway system.

The ratio of annual average daily traffic (AADT) to capacity was used to measure current congestion levels. Figure 7.2 shows the relationship between average speed and the ratio of AADT to hourly capacity for a six-lane freeway with 6+ foot shoulders and a free flow speed of 60 miles per hour.

**Figure 7.2 Effect of Congestion on Average Speed**  
*Six-Lane Freeway With 6+ Foot Shoulders*

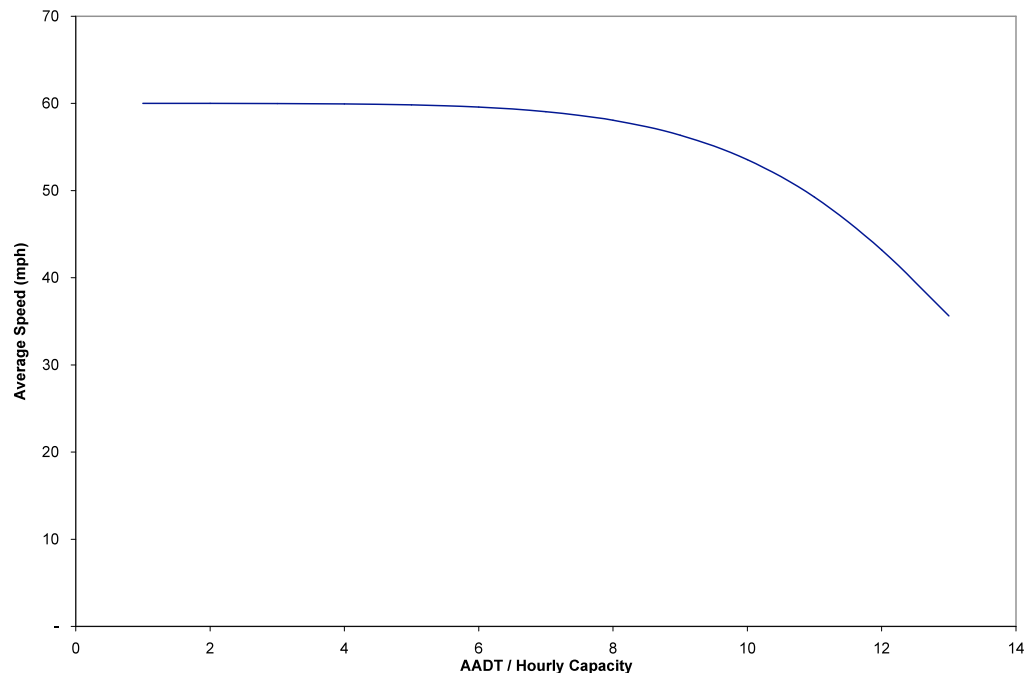

Source: Developed using speed models from FHWA's Highway Economic Requirements System (HERS).

## 7.8 ENERGY AND THE ENVIRONMENT

Finally, the study team estimated the impact of the proposed changes on energy consumption and emissions of the new truck configurations. This portion of the analysis consisted of two steps:

- **Step 1** - Obtain impacts of scenarios on fuel consumption from goods movement cost analysis; and
- **Step 2** - Calculate Scenario impacts on carbon dioxide (CO<sub>2</sub>), particulate matter (PM), and nitrogen oxides based on fuel consumption impact.

The American Transportation Research Institute (ATRI) report, *Energy and Emissions Impacts of Operating Higher Productivity Vehicles Update: 2008* provides the following estimates of emissions per gallon of fuel consumed:

- Carbon dioxide: 22.2 pounds per gallon of diesel fuel;
- Particulate matter: 0.11 grams per gallon of diesel fuel; and
- Nitrogen oxides: 23.0 grams per gallon of diesel fuel.



A 2002 EPA Technical Report, *A Comprehensive Analysis of Biodiesel Impacts on Exhaust Emissions*, indicates that 100 percent biodiesel fuel typically reduces fuel economy by 1 to 2 percent, reduces particulate matter by 47 percent, and increases nitrogen oxides by 10 percent. The study team used this information to perform sensitivity analyses based on alternative assumptions about the use of biodiesel to replace conventional diesel fuel.



# 8.0 Results and Recommendations

## 8.1 SUMMARY

This section presents the results of the analysis of the potential configuration changes and summarizes potential policy recommendations for further consideration by the Wisconsin Department of Transportation and Wisconsin Legislature. Based on the analysis of the configurations, the changes to TSW laws in Wisconsin would generate significant positive net benefits. The analysis shows that savings would accrue across all categories except structures, where the Scenario configurations would require additional investment to replace, reinforce, or post some bridges. A major investment is necessary to maintain and upgrade the inventory of bridges and structures to allow for the current size and weight limit vehicle load as well as any adjustments to the TSW loading. Without significant investment, heavy trucks will face longer routes as additional bridges are posted. Noncompliance to bridge postings (a safety risk and significant infrastructure cost) will continue to be a major enforcement issue.

The greatest source of cost savings, if implemented, is the 6-axle 98,000-pound configuration, which provides the highest goods movement, safety, and congestion savings. The six-axle 90,000-pounds and seven-axle 97,000-pound configurations provide ample goods movement savings and pavement savings.

Tables 8.1 and 8.2 show the best estimates of the impacts of potential allowable configuration changes on Wisconsin's roadways and economy. Additional results tables are shown through the section that highlight possible impacts based on other assumptions in order to highlight the influence of certain factors (such as diversion of freight from railroads) on the findings.

## 8.2 CONFIGURATION ANALYSIS

This section presents the results of the analysis of impacts of potential allowable configuration changes in Wisconsin's truck size and weight laws.

Estimates are presented for the following configurations (with abbreviations shown):

- Six-axle 90,000-pound tractor-semitrailer (6a TST 90);
- Seven-axle 97,000-pound tractor-semitrailer (7a TST 97);
- Seven-axle 80,000-pound single unit truck (7a SU 80); and
- Eight-axle 108,000-pound double (8a D 108).

In addition to these four configurations, the analysis considered the following two 6-axle 98,000 pound configurations which do not meet the Federal Bridge Formula but are both currently in use through exceptions in Wisconsin law:

- Six-axle 98,000-pound tractor-semitrailer (6a TST 98) (evaluated configuration does not meet the Federal Bridge Formula); and
- Six-axle 98,000-pound straight truck-trailer (6a STT 98) (evaluated configuration does not meet the Federal Bridge Formula).

In this document, these configurations are referred to as Scenario trucks. Trucks that are currently allowed to operate in Wisconsin without special permits or conditions are referred to as Base Case trucks.

Estimates are developed under two different assumptions about where Scenario trucks would be allowed to operate:

- **Non-Interstates Only.** Scenario trucks are allowed to operate on all non-Interstate highways on which five-axle 80,000-pound tractor-semitrailers currently are allowed.
- **All Highways.** Scenario trucks are allowed to operate on all highways on which five-axle 80,000 pound tractor-semitrailers currently are allowed. For this assumption, Federal truck size and weight laws would have to be modified since under current Federal laws, the Scenario trucks are not allowed on Interstate highways. The results for the All Highways analysis are shown in Section 8.3.

Table 8.1 shows the results of the five criteria used to evaluate the potential introduction of the six candidate trucks on Wisconsin highways (assuming candidate configurations are not allowed on the Interstate system). The five evaluation criteria include transport cost, safety, congestion, pavements, and bridges for the new configurations compared to the base case scenario with an 80,000 gross vehicle weight limit. The results are expressed in millions of annual dollars per year. One-time costs for bridge replacements were annualized assuming a 10-year performance period and a 5 percent discount rate. The evaluation results for transport cost, safety, congestion, and pavement do not include any inflationary factor. The degree to which the State realizes these benefits depends upon the rate of conversion of the truck fleet to the new configurations and the amount of investment in infrastructure, without which none of the benefits would be possible.

The tables organize the criteria by beneficiaries – system users and public agencies – to demonstrate which group receives cost savings (benefits) or is impacted by increased costs (expressed as negative costs in parentheses). The system users are the private companies and individuals who use the Wisconsin highway system. The public agencies are those State and local government entities that bear the direct responsibility of maintaining the transportation system.

The five evaluation criteria include the following measures:

1. **Transport cost savings** accrue to private carriers resulting from the productivity increase of heavier or larger trucks, which allows them to carry more freight with fewer trucks. The savings of a smaller, more productive fleet include lower driver, repair, fuel, tire, and overhead costs and in this

analysis also account for equipment conversion/upgrade costs. Presumably these cost savings also benefit shippers (lower shipper rates) and consumers (lower purchase costs as a share of lower transport costs are passed on).

2. **Safety cost savings** accrue to private freight carriers and the general driving public from the reduction in truck vehicle miles traveled (VMT) associated with TSW changes. The lower truck VMT reduces the potential for heavy trucks to be involved in accidents. While crash probability generally increases with weight of a truck, the lower number of trucks combined with increased braking power from additional axles results in fewer accidents involving heavy trucks statewide. The net safety benefits include lower costs associated with fatalities, injuries, and property damage.
3. **Congestion cost savings**, as mentioned above, accrue to private carriers, and drivers of personal vehicles. The congestion cost savings result from fewer trucks on the highways creating less delay and generating time savings, especially on urban highways.
4. **Pavement cost savings** accrue to the public agencies that avoid maintenance costs due to the lower ESAL impacts provided by distributing truck weight over additional axles. Some pavement savings are also related to lower truck VMT.
5. **Bridge costs** are shown in two columns to reflect the bridge costs associated with the TSW proposal and the base scenario needs of the State's bridge system<sup>63</sup>. The first column "Bridge Costs for TSW Configs" accounts for costs associated with bridge replacement, repair, or upgrade required for the proposed configurations. The second column "Baseline Bridge Costs" expresses the existing bridge needs in the State estimated at \$55.5 million per year. These baseline bridge costs would have to be funded to support baseline conditions or any heavier trucks.

While the bridge cost estimates reflect costs estimated for this study, Table 8.1 **does not account for the entire magnitude of the state and local bridge replacement costs for heavy truck operations**. The total cost to replace all statewide deficient bridges on both the state and local routes far exceeds the amount shown (see Section 7.0 for greater detail). The total cost to replace all statewide structures less than 20 feet also exceeds the amount shown in the following tables and requires additional evaluation and study. These results only account for the bridge replacement cost associated with the candidate configuration vehicles' impacts on bridges. WisDOT has

---

<sup>63</sup>All estimated bridge replacement costs are based on current deck areas, assume bridge construction costs only, and only consider Wisconsin's most common bridge types. Actual costs may be higher due to larger deck areas for new bridges, roadway approach work associated with each bridge replacement, and additional bridge types in need of replacement that were not considered in the study.

maintained that the Department cannot support changes that add to infrastructure costs without provisions that fund those added costs.

**Table 8.1 Annual Costs and Benefits for Candidate Configurations**  
*Operating on Non-Interstate Highways Only*

Fed Bridge Formula	Configuration	System User Benefits			Public Agency Benefits and Impacts			Net Benefits	
		Transport Savings	Safety	Congestion	Pavement	Bridge Costs for TSW Configs	Baseline Bridge Costs	With TSW Bridge Costs Only	With All Bridge Costs
Y	Base Case	0.00	0.00	0.00	0.00	0.00	(55.50)	0.00	(55.50)
Y	6a TST 90	5.50	0.46	0.92	2.57	(2.18)	(55.50)	7.26	(48.24)
Y	7a TST 97	6.27	0.70	0.85	3.87	(3.08)	(55.50)	8.62	(46.88)
Y	7a SU 80	2.46	0.11	0.08	0.40	(2.26)	(55.50)	0.78	(54.72)
Y	8a D 108	3.42	0.46	0.49	3.34	(6.02)	(55.50)	1.69	(53.81)
N	6a TST 98	19.19	1.52	1.89	1.10	(8.48)	(55.50)	15.23	(40.27)
N	6a STT 98	2.19	0.09	0.06	0.03	(4.22)	(55.50)	(1.85)	(57.35)

Note: All values in millions (assumes non-Interstate highway operation only).

Note that the results shown in Table 8.1 assume a 10 percent shift of freight carried by Scenario trucks from the Interstate system to non-Interstate highways. The Base Case Scenario assumes that five-axle, 80,000 pound trucks are carrying the freight which would potentially shift to the candidate configurations.

The major finding of this analysis is that 5 of the 6 truck configurations reviewed generate net statewide benefits if they are allowed on non-Interstate highways and if the impacts on bridges are limited to the direct impacts of the new truck configurations (see Table 8.1 column “Net Benefits With TSW Bridge Costs Only”). However, because the State faces baseline maintenance needs to support existing truck traffic on its structures, the backlog of total state bridge costs overwhelms the benefits for all trucks in this evaluation, unless they are also allowed to operate on the Interstate system.

Taking into account the total bridge costs and the ability to operate on the Interstate, the most successful new configuration, in terms of net benefits, is the six-axle 98,000 semitrailer (6a TST 98), which generates the highest savings in transport costs, safety, and congestion. However, this truck, while currently operating under exception in Wisconsin, does not meet the Federal Bridge Formula with its commonly used axle spacings. The next most beneficial truck is the seven-axle 97,000 pound semitrailer (7a TST 97) followed by the marginally beneficial six-axle 90,000 pound semitrailer (6a TST 90).

Independent of the bridge considerations, all proposed configurations generate positive benefits across the four other evaluation criteria – transport costs, safety, congestion, and pavements. The most pavement-friendly configurations are those with the greatest distribution of weight across axles (lowest ESAL impacts),

including the 7-axle 97,000 pound semitrailer and the 8-axle single unit. The six-axle 90,000 pound semitrailer also exhibits high pavement savings.

Table 8.2 shows annual transport cost savings broken down by cost component for each of the Scenario configurations.

**Table 8.2 Annual Transport Cost Savings**

Configuration	Drivers	Vehicle	Fuel	Tires	Repair	Overhead	Total
6a TST 90	1.38	0.92	1.52	0.16	0.50	1.01	<b>5.50</b>
7a TST 97	1.54	1.03	1.84	0.18	0.56	1.13	<b>6.27</b>
7a SU 80	0.80	0.54	0.14	0.09	0.29	0.59	<b>2.46</b>
8a D 108	0.91	0.60	0.81	0.11	0.33	0.66	<b>3.42</b>
6a TST 98	4.98	3.32	4.85	0.58	1.81	3.65	<b>19.19</b>
6a STT 98	0.70	0.46	0.19	0.08	0.25	0.51	<b>2.19</b>

Note: All Values in Millions (assumes non-Interstate highway operation only).

Estimates are also presented for reductions in fuel consumption and emissions of carbon dioxide, particulate matter, and nitrogen oxides resulting from the introduction of Scenario trucks in Table 8.3.

Table 8.3 shows that the 6-axle 98,000 pound semitrailer (6a TST 98) has the highest fuel and emissions reductions because it diverts the most payload ton-miles from the base case truck (5-axle 80,000 pound semitrailer). Other trucks with high energy and emissions benefits include the 7-axle 97,000 pound semitrailer (7a TST 97) and the 6-axle 90,000 pound semitrailer (6a TST 90) combinations.

**Table 8.3 Annual Fuel and Emissions Reductions for Candidate Configurations**

Configuration	Diverted Payload Ton-Miles	Fuel (Gallons)	CO <sub>2</sub> (Pounds)	PM (Grams)	NO <sub>x</sub> (Grams)
6a TST 90	540	0.45	9.94	0.05	10.29
7a TST 97	450	0.54	11.97	0.06	12.40
7a SU 80	25	0.04	0.92	0.00	0.96
8a D 108	300	0.24	5.26	0.03	5.45
6a TST 98	900	1.42	31.62	0.16	32.76
6a STT 98	15	0.06	1.22	0.01	1.27

Note: All Values in Millions (assumes non-Interstate highway operation only).

As noted above, cost savings are primarily due the diversion of freight from Base Case to Scenario trucks. Table 8.3 also shows estimates of how much freight (measured in payload ton-miles per year) would divert from Base Case to Scenario trucks.

Estimates of payload ton-miles diverted to each Scenario truck are based on the assumption that the Scenario truck is implemented by itself. If all Scenario trucks were implemented, the 98,000 pound 6-axle tractor-semitrailer would capture most of the diversion from Base Case tractor-semitrailers.

Table 8.4 shows estimates of how much freight (measured in payload ton-miles per year) would divert from Base Case to Scenario trucks and the associated effects on vehicle miles of travel (VMT). The estimates of diversion presented in this table and in Section 8.3 assume that only Wisconsin truck size and weight limits would be modified. If neighboring states also modified their truck size and weight limits to allow the operation of Scenario trucks, it is likely that diversion from Base Case to Scenario trucks would be much greater. This is because trucks operating in more than one state can carry only that weight allowed by the least permissive state. Also, many interstate trucking firms will not purchase new equipment if it can only be used in one of the states in which they operate.

**Table 8.4 Annual Changes in VMT Based on Diversion to Candidate Configurations**

Configuration	Diverted Payload Ton-Miles (Millions)	Vehicle Miles of Travel (VMT, in Millions)			Percent Change in Heavy Truck VMT on Wisconsin Highways		
		Base Case	Scenario Config	Net Change	Interstate	Non-Interstate	All Highways
6a TST 90	540	-27.0	23.4	-3.6	-0.13%	-0.02%	-0.06%
7a TST 97	450	-22.5	18.0	-4.5	-0.11%	-0.06%	-0.07%
7a SU 80	25	-2.6	2.3	-0.3	-0.01%	0.00%	-0.01%
8a D 108	300	-15.0	11.3	-3.7	-0.07%	-0.06%	-0.06%
6a TST 98	900	-45.0	34.0	-11.0	-0.21%	-0.17%	-0.18%
6a STT 98	15	-1.3	1.0	-0.3	-0.01%	-0.01%	-0.01%

Note: Assumes non-Interstate highway operation only.

Table 8.5 shows cost savings for pavements and bridge decks broken down by highway system. Some pavement cost savings are shown on Interstates for this case where Scenario trucks are allowed only on non-Interstates since some freight would shift from Base Case trucks on Interstates to Scenario trucks on non-Interstates.



**Table 8.5 Annual Pavement Cost Savings for Candidate Configurations**

	Scenario Trucks					
	6a TST 90	7a TST 97	7a SU 80	8a D 108	6a TST 98	6a STT 98
Rural Interstates	0.12	0.10	0.01	0.07	0.21	0.00
Other Rural State Highways	0.98	1.58	0.11	1.33	0.32	0.00
Other Rural Highways	0.15	0.24	0.05	0.20	0.05	0.00
Urban Interstates	0.17	0.14	0.01	0.10	0.29	0.01
Other Urban State Highways	0.57	0.90	0.07	0.84	0.10	0.00
Other Urban Highways	0.57	0.91	0.15	0.81	0.14	0.01
<b>Total</b>	<b>2.57</b>	<b>3.87</b>	<b>0.40</b>	<b>3.34</b>	<b>1.10</b>	<b>0.03</b>

Note: All Values in Millions (assumes non-Interstate highway operation only).

For the case where Scenario trucks are allowed on non-Interstates only, it was assumed that 10 percent of the freight carried by Scenario trucks would be diverted from Interstates (see Table 8.1). Tables 8.6 and 8.7 show the results of sensitivity tests using alternative assumptions. Table 8.6 shows the results of assuming 20 percent diversion from Interstates and Table 8.7 shows the results of assuming no diversion from Interstates.

**Table 8.6 Annual Costs and Benefits for Candidate Configurations Assuming 20 Percent Shift of Freight from Interstate to Non-Interstate**

Fed Bridge Formula	Configuration	System User Benefits			Public Agency Benefits and Impacts			Net Benefits	
		Transport Savings	Safety	Congestion	Pavement	Bridge Costs for TSW Configs	Baseline Bridge Costs	With TSW Bridge Costs Only	With All Bridge Costs
Y	Base Case	0	0	0	0	0.00	(55.50)	0.00	(55.50)
Y	6a TST 90	5.50	0.23	1.48	1.97	(2.18)	(55.50)	7.00	(48.50)
Y	7a TST 97	6.27	0.51	1.32	3.37	(3.08)	(55.50)	8.40	(47.10)
Y	7a SU 80	2.46	0.08	0.13	0.36	(2.26)	(55.50)	0.77	(54.73)
Y	8a D 108	3.42	0.33	0.81	3.01	(6.02)	(55.50)	1.54	(53.96)
N	6a TST 98	19.19	1.14	2.84	0.11	(8.48)	(55.50)	14.79	(40.71)
N	6a STT 98	2.19	0.07	0.09	0.01	(4.22)	(55.50)	(1.85)	(57.35)

Note: All values in millions (assumes non-Interstate highway operation only).

**Table 8.7 Annual Costs and Benefits for Candidate Configurations Assuming No Shift of Freight from Interstate to Non-Interstate**

Fed Bridge Formula	Configuration	System User Benefits			Public Agency Benefits and Impacts			Net Benefits	
		Transport Savings	Safety	Congestion	Pavement	Bridge Costs for TSW Configs	Baseline Bridge Costs	With TSW Bridge Costs Only	With All Bridge Costs
Y	Base Case	0	0	0	0	0.00	(55.50)	0.00	(55.50)
Y	6a TST 90	5.50	0.73	0.24	3.29	(2.18)	(55.50)	7.57	(47.93)
Y	7a TST 97	6.27	0.93	0.28	4.47	(3.08)	(55.50)	8.88	(46.62)
Y	7a SU 80	2.46	0.15	0.01	0.44	(2.26)	(55.50)	0.80	(54.70)
Y	8a D 108	3.42	0.61	0.11	3.74	(6.02)	(55.50)	1.86	(53.64)
N	6a TST 98	19.19	1.98	0.75	2.30	(8.48)	(55.50)	15.75	(39.75)
N	6a STT 98	2.19	0.11	0.02	0.05	(4.22)	(55.50)	(1.84)	(57.34)

Note: All values in millions (assumes non-Interstate highway operation only).

Estimates of transport, pavement and bridge deck, safety, and congestion cost savings for each Scenario truck vary in direct proportion to the amount of freight attracted from Base Case trucks. Tables 8.8 and 8.9 show the results of sensitivity tests in which diversion is doubled and halved, respectively.

**Table 8.8 Annual Costs and Benefits for Candidate Configurations Assuming Double the Amount of Diversion to Configurations**

Fed Bridge Formula	Configuration	System User Benefits			Public Agency Benefits and Impacts			Net Benefits	
		Transport Savings	Safety	Congestion	Pavement	Bridge Costs for TSW Configs	Baseline Bridge Costs	With TSW Bridge Costs Only	With All Bridge Costs
Y	Base Case	0	0	0	0	0.00	(55.50)	0.00	(55.50)
Y	6a TST 90	10.99	0.92	1.83	5.13	(2.18)	(55.50)	16.69	(38.81)
Y	7a TST 97	12.55	1.41	1.69	7.74	(3.08)	(55.50)	20.32	(35.18)
Y	7a SU 80	4.92	0.22	0.16	0.79	(2.26)	(55.50)	3.82	(51.68)
Y	8a D 108	6.83	0.92	0.98	6.69	(6.02)	(55.50)	9.40	(46.10)
N	6a TST 98	38.38	3.04	3.78	2.21	(8.48)	(55.50)	38.94	(16.56)
N	6a STT 98	4.38	0.18	0.12	0.06	(4.22)	(55.50)	0.53	(54.97)

Note: All values in millions (assumes non-Interstate highway operation only).

**Table 8.9 Annual Costs and Benefits for Candidate Configurations Assuming One-Half the Amount of Diversion to Configurations**

Fed Bridge Formula	Configuration	System User Benefits			Public Agency Benefits and Impacts			Net Benefits	
		Transport Savings	Safety	Congestion	Pavement	Bridge Costs for TSW Configs	Baseline Bridge Costs	With TSW Bridge Costs Only	With All Bridge Costs
Y	Base Case	0	0	0	0	0.00	(55.50)	0.00	(55.50)
Y	6a TST 90	2.75	0.23	0.46	1.28	(2.18)	(55.50)	2.54	(52.96)
Y	7a TST 97	3.14	0.35	0.42	1.94	(3.08)	(55.50)	2.77	(52.73)
Y	7a SU 80	1.23	0.05	0.04	0.20	(2.26)	(55.50)	(0.74)	(56.24)
Y	8a D 108	1.71	0.23	0.25	1.67	(6.02)	(55.50)	(2.17)	(57.67)
N	6a TST 98	9.60	0.76	0.94	0.55	(8.48)	(55.50)	3.37	(52.13)
N	6a STT 98	1.10	0.05	0.03	0.01	(4.22)	(55.50)	(3.03)	(58.53)

Note: All values in millions (assumes non-Interstate highway operation only).

Safety cost savings were estimated by applying dollar values to reductions in the number of fatal, injury, and property damage only crashes. The unit costs used for this purpose include estimates of the dollar values associated with pain and suffering due to shortened lives and reduced quality of life. Table 8.10 shows the results of a sensitivity test in which dollar values associated with pain and suffering are not included.

**Table 8.10 Annual Costs and Benefits for Candidate Configurations Without Dollar Values Associated With Pain and Suffering**

Fed Bridge Formula	Configuration	System User Benefits			Public Agency Benefits and Impacts			Net Benefits	
		Transport Savings	Safety	Congestion	Pavement	Bridge Costs for TSW Configs	Baseline Bridge Costs	With TSW Bridge Costs Only	With All Bridge Costs
Y	Base Case	0	0	0	0	0.00	(55.50)	0.00	(55.50)
Y	6a TST 90	5.50	0.23	0.92	2.57	(2.18)	(55.50)	7.03	(48.47)
Y	7a TST 97	6.27	0.36	0.85	3.87	(3.08)	(55.50)	8.27	(47.23)
Y	7a SU 80	2.46	0.06	0.08	0.40	(2.26)	(55.50)	0.73	(54.77)
Y	8a D 108	3.42	0.23	0.49	3.34	(6.02)	(55.50)	1.46	(54.04)
N	6a TST 98	19.19	0.77	1.89	1.10	(8.48)	(55.50)	14.48	(41.02)
N	6a STT 98	2.19	0.05	0.06	0.03	(4.22)	(55.50)	(1.89)	(57.39)

Note: All values in millions (assumes non-Interstate highway operation only).

Pavement cost savings were estimated based on the assumption that WisDOT and other transportation agencies would reduce expenditures on pavements in response to reduced traffic loadings. Alternatively, if transportation agencies did

not reduce expenditures on pavements, the cost savings associated with reduced traffic loadings would accrue to system users rather than public agencies such as WisDOT. Table 8.9 shows the results of a sensitivity test in which it is assumed that the cost savings accrue to road users rather than transportation agencies. Pavement savings are greater under this assumption, reflecting the fact pavement projects typically have benefit-cost ratios much greater than 1.0.

**Table 8.11 Annual Costs and Benefits for Candidate Configurations With No Pavement Expenditure Reduction**

Fed Bridge Formula	Configuration	System User Benefits			Public Agency Benefits and Impacts			Net Benefits	
		Transport Savings	Safety	Congestion	Pavement	Bridge Costs for TSW Configs	Baseline Bridge Costs	With TSW Bridge Costs Only	With All Bridge Costs
Y	Base Case	0	0	0	0	0.00	(55.50)	0.00	(55.50)
Y	6a TST 90	5.50	0.46	0.92	6.41	(2.18)	(55.50)	11.10	(44.40)
Y	7a TST 97	6.27	0.70	0.85	8.89	(3.08)	(55.50)	13.64	(41.86)
Y	7a SU 80	2.46	0.11	0.08	0.79	(2.26)	(55.50)	1.18	(54.32)
Y	8a D 108	3.42	0.46	0.49	7.47	(6.02)	(55.50)	5.81	(49.69)
N	6a TST 98	19.19	1.52	1.89	4.22	(8.48)	(55.50)	18.34	(37.16)
N	6a STT 98	2.19	0.09	0.06	0.09	(4.22)	(55.50)	(1.78)	(57.28)

Note: All values in millions (assumes non-Interstate highway operation only).

Transport cost savings were calculated using a diesel fuel price of \$3.41 per gallon. This is the average pump price of diesel fuel in Midwestern states, less tax from January 1 to December 1, 2008. Currently, the average pump price less tax is about \$2.11, almost 40 percent below the average 2008 price. During July, however, the average pump price less tax was almost \$4.20. Table 8.10 and Table 8.11 show the results of sensitivity tests in which diesel fuel prices of \$2.05 (down 40 percent from \$3.41) and \$4.77 (up 40 percent from \$3.41) were assumed.

**Table 8.12 Annual Costs and Benefits for Candidate Configurations with Reduced Diesel Fuel Price of \$2.05**

Fed Bridge Formula	Configuration	System User Benefits			Public Agency Benefits and Impacts			Net Benefits	
		Transport Savings	Safety	Congestion	Pavement	Bridge Costs for TSW Configs	Baseline Bridge Costs	With TSW Bridge Costs Only	With All Bridge Costs
Y	Base Case	0	0	0	0	0.00	(55.50)	0.00	(55.50)
Y	6a TST 90	4.89	0.46	0.92	2.57	(2.18)	(55.50)	6.65	(48.85)
Y	7a TST 97	5.54	0.70	0.85	3.87	(3.08)	(55.50)	7.88	(47.62)
Y	7a SU 80	2.40	0.11	0.08	0.40	(2.26)	(55.50)	0.72	(54.78)
Y	8a D 108	3.09	0.46	0.49	3.34	(6.02)	(55.50)	1.37	(54.13)
N	6a TST 98	17.25	1.52	1.89	1.10	(8.48)	(55.50)	13.29	(42.21)
N	6a STT 98	2.12	0.09	0.06	0.03	(4.22)	(55.50)	(1.92)	(57.42)

Note: All values in millions (assumes non-Interstate highway operation only).

**Table 8.13 Annual Costs and Benefits for Candidate Configurations with Increased Diesel Fuel Price of \$4.77**

Fed Bridge Formula	Configuration	System User Benefits			Public Agency Benefits and Impacts			Net Benefits	
		Transport Savings	Safety	Congestion	Pavement	Bridge Costs for TSW Configs	Baseline Bridge Costs	With TSW Bridge Costs Only	With All Bridge Costs
Y	Base Case	0	0	0	0	0.00	(55.50)	0.00	(55.50)
Y	6a TST 90	6.11	0.46	0.92	2.57	(2.18)	(55.50)	7.87	(47.63)
Y	7a TST 97	7.01	0.70	0.85	3.87	(3.08)	(55.50)	9.35	(46.15)
Y	7a SU 80	2.51	0.11	0.08	0.40	(2.26)	(55.50)	0.84	(54.66)
Y	8a D 108	3.74	0.46	0.49	3.34	(6.02)	(55.50)	2.01	(53.49)
N	6a TST 98	21.13	1.52	1.89	1.10	(8.48)	(55.50)	17.17	(38.33)
N	6a STT 98	2.27	0.09	0.06	0.03	(4.22)	(55.50)	(1.77)	(57.27)

Note: All values in millions (assumes non-Interstate highway operation only).

In the future, emissions of carbon dioxide from trucks could be reduced substantially through the use of bio-diesel. Table 8.12 presents the results of a sensitivity test in which it is assumed that trucks are powered by 20 percent bio-diesel. This table can be compared to Table 8.2 to see the reduction in emissions.

**Table 8.14 Annual Costs and Benefits for Candidate Configurations**  
*Assuming Trucks are Powered by 20 Percent Bio-Diesel*

Configuration	Diverted Payload Ton-Miles	Fuel (gallons)	CO2 (pounds)	PM (grams)	NOX (grams)
6a TST 90	540	0.45	8.39	0.05	10.34
7a TST 97	450	0.54	10.10	0.06	12.45
7a SU 80	25	0.04	0.78	0.00	0.96
8a D 108	300	0.24	4.44	0.03	5.47
6a TST 98	900	1.42	26.69	0.15	32.89
6a STT 98	15	0.06	1.03	0.01	1.27

Note: All Values in Millions (assumes non-Interstate highway operation only)

### Rail Diversion Sensitivity Analysis

In addition to diversion from Base Case to Scenario trucks, the possibility that Scenario trucks might cause increases in the total amount of freight carried on the highway system was considered. This increase might occur as a result of 1) diversion from rail to truck or 2) an increase in the total amount of freight shipped. Sensitivity analyses were performed to investigate how different assumptions would affect the evaluation of Scenario trucks. Sensitivity tests estimated the effects of increasing the amount of freight carried by Scenario trucks by 5 percent, 10 percent, and 15 percent due to a combination of diversion from rail and increases in the total amount of freight shipped. In these tests, transport cost savings are increase since shippers would not shift from rail to truck or increase the amount that they ship unless it is in their economic interest to do so. However, cost savings for pavements and bridge decks, safety, and congestion are reduced or, in some cases, eliminated, because of greater truck VMT.

While these sensitivity results indicate potential changes in cost savings and impacts if freight moved from rail to truck, this study concludes that diversion from rail would be negligible (especially if increases in truck weight limits are limited to non-Interstates in Wisconsin) because:

- Most of the competition between truck and rail is for long-distance shipments (e.g., over 500 miles);
- Private sector outreach participants did not believe TSW changes would divert traffic from rail, in part because of rail's continued focus on long-haul, high-value commodities<sup>64</sup>; and
- For the same reasons, the Peer Review Panel agreed rail diversion would be minimal.

If the State wanted to develop more detailed rail diversion impacts, it would conduct market-based assessments of specific corridors or commodities. The amount diversion could be estimated through an analysis of truck/rail mode share in similarly situated corridors/regions, including states with similar geographies, industries, and more liberal TSW laws. The results of the diversion estimate would also need to reflect economic realities of businesses working to minimize shipping unit costs per mile. The results of such an analysis could more definitively assess the impacts on railroads, especially shortline or regional haulers.

### **Safety Performance Analysis**

All heavier vehicles proposed in the project were evaluated against internationally accepted safety performance standards such as rollover threshold and offtracking. Of the configurations analyzed, the six-axle 98,000 pound straight truck-trailer (6a STT 98) failed to satisfy the load transfer ratio and static rollover threshold performance measures while the seven-axle 80,000 pound single unit truck (7a SU 80) failed the low-speed steer axle friction utility test. The 6a STT 98 configuration is most frequently operated by the timber industry and while the configuration demonstrates a higher rollover risk in laboratory conditions, industry representatives report no observed rollover issues in the field, possibly due to lower operating speeds, load configuration, and experienced drivers. All other configurations met basic international standards. In the area of low-speed offtracking (an important indicator of performance in roundabouts), all of the vehicles examined were within the acceptable limits. Appendix C details the full results of this analysis. In addition, the review of international practice revealed for this study that technology enhancements – such as roll stability features – can further improve the safety performance of heavy trucks.

Finally, configuration evaluation results show that there is greater surplus brake capacity for all of the proposed vehicle configurations than for the standard five-axle tractor semitrailer because of the additional axles required. This means that under loaded conditions, the proposed vehicle configurations should have better stopping distance performance than the existing five-axle tractor semitrailers.

---

<sup>64</sup>Many of the Wisconsin commodities benefiting from TSW changes are low-value, heavy freight shipments of agricultural, scrap, and forest products.

### 8.3 IMPACT OF INTERSTATE SYSTEM RESTRICTIONS

Interstate highways, though restricted to 80,000 pounds GVW by Federal law, are included in the analysis of alternative truck configurations. This inclusion assures a comprehensive picture of heavier truck impacts on the Wisconsin road network. However, the inclusion of the Interstates does not imply that heavier vehicles will be allowed on these highways without Federal consent. Moreover, the Federal penalty for raising the weight limit on the Interstate is up to a 10 percent annual reduction of a State's apportionment funds. Wisconsin's FFY 2009 apportioned Federal funds is \$626,506,388.

This analysis confirms what was intuitively known by the participants in the study outreach meeting. Allowing heavier trucks on Interstate highways would decrease the impact on State and local roads. Impact estimates are shown in Table 8.13.

**Table 8.15 Annual Costs and Benefits for Candidate Configurations**  
*Assuming Interstate Operation is Allowable*

Fed Bridge Formula	Configuration	System User Benefits			Public Agency Benefits and Impacts			Net Benefits	
		Transport Savings	Safety	Congestion	Pavement	Bridge Costs for TSW Configs	Baseline Bridge Costs	With TSW Bridge Costs Only	With All Bridge Costs
Y	Base Case	0	0	0	0	0.00	(55.50)	0.00	(55.50)
Y	6a TST 90	36.64	3.48	3.44	14.65	(2.18)	(55.50)	56.03	0.53
Y	7a TST 97	41.83	4.43	4.08	19.91	(3.08)	(55.50)	67.18	11.68
Y	7a SU 80	9.83	0.53	0.09	1.53	(2.26)	(55.50)	9.73	(45.77)
Y	8a D 108	22.77	2.90	1.65	16.76	(6.02)	(55.50)	38.06	(17.44)
N	6a TST 98	127.94	9.40	11.03	10.19	(8.48)	(55.50)	150.09	94.59
N	6a STT 98	14.61	0.68	0.26	0.32	(4.22)	(55.50)	11.65	(43.85)

Note: All values in millions (assumes Interstate highway and non-Interstate highway operation).

Cost savings in all categories are much greater if Scenario trucks are allowed on Interstate highways because the diversion of freight from Base Case trucks is much greater in this case. Also, Interstates are frequently better designed to handle heavy trucks, since Interstate pavements tend to be thicker than non-Interstates and truck crash costs per vehicle mile are lower on Interstates.

Taking into account the total bridge costs and the ability to operate on the Interstate, the most successful new configuration, in terms of net benefits, is the 6-axle 98,000 semitrailer (6a TST 98), which generates the highest savings in transport costs, safety, and congestion. However, this truck, while currently operating under exception in Wisconsin, does not meet the Federal Bridge Formula with its commonly used axle spacings. The next most beneficial truck is the 7-axle 97,000 pound semitrailer (7a TST 97) followed by the marginally beneficial 6-axle 90,000 pound semitrailer (6a TST 90).



Table 8.16 shows the comparison of the change in heavy truck VMT on Wisconsin's highways between the Non-Interstates and All Highways Scenarios. Percentage changes in heavy truck traffic are more significant when Interstates are included. For example, allowing the 6-axle, 90,000 pound semi to operate on non-Interstate highways could reduce heavy truck VMT in Wisconsin by 0.06 percent, but allowing it to operate on Interstates could reduce heavy truck VMT by 0.40 percent (nearly seven times as much).

**Table 8.16 Changes in VMT for Non-Interstate versus All Highways Scenarios**

Configuration	Percentage Change in Heavy Truck VMT on Wisconsin's Highways	
	If Operable on Non-Interstate Highways	If Operable on All Highways
6a TST 90	-0.06%	-0.40%
6a TST 98	-0.18%	-1.21%
7a TST 97	-0.07%	-0.50%
7a SU 80	-0.01%	-0.02%
8a D 108	-0.06%	-0.40%
6a STT 98	-0.01%	-0.04%

## 8.4 POLICY DIRECTIONS AND OPTIONS

This study has focused on three key questions: 1) Should changes be made to Wisconsin's TSW Laws? 2) What impacts would changes to TSW laws have on the state's roads and bridges, regulatory and enforcement capabilities, administrative processes, and freight transportation modes? 3) What specific requirements need to be met by any vehicles operating under modified size/weight standards. The policy recommendation that emerges from addressing these objectives must strike a balance between the economic benefits achieved through freight productivity improvement and the need to protect public safety and preserve state and local roads and bridges.

In view of current national/international economic conditions, declining state revenue, and costs associated with allowing heavier vehicles on state and local roads, the Department of Transportation recommends that no changes be made to Wisconsin's TSW laws at this time. WisDOT has historically opposed legislation allowing heavier trucks in recognition of the higher public investments necessary to accommodate those heavier vehicles.

However, this report provides an excellent basis for a continuing dialogue with the legislature, local governments, the Federal government, other Midwestern states, and Wisconsin citizens and private sector regarding potential improvements to TSW policy and regulation. Towards that end the following strategies may be pursued in the immediate future as funds allow:

1. **Conduct a comprehensive study of truck crash trends on Wisconsin's state and local highway network.** Nationally, as well as in the State of Wisconsin, the number and rate of large truck crashes and fatalities is trending downward while large truck vehicle mileage continues to increase. However, while there have been decreases overall, there remain significant differences in large truck crash rates when examined at the county level. Further study needs to focus on the reasons for the differences and should also focus on the differences in crash rates – using available data – between configuration types (semitrailers, doubles, etc.).
2. **Increase the visibility and coordination of freight efforts within WisDOT to more effectively address emerging freight-related issues.** Any organizational adjustment must consider emerging freight policy, planning, operations, and investment requirements. The American Association of State Highway and Transportation Officials (AASHTO) recent recommendation that Congress authorize a state administered freight transportation program funded at \$18 billion for six years apportioned annually to the states to support highway freight transportation infrastructure improvements is an example of a national policy development that could significantly impact the States organizational structure.
3. **Review oversize/overweight permitting process.** A review of the Department's organization structure by which freight and truck issues are managed will also include an assessment of the Department's oversize/overweight permit process including the feasibility of establishing a performance-based permit program for heavier vehicles. In addition, the review will examine the methods by which Wisconsin sets truck registration fees and truck overweight/oversize fines and how the State can foster better permit coordination and potentially standardization with local jurisdictions. Additional study by the State is underway to determine what programmatic changes could be made to enhance permit activities, including possible adaptation for changing load demands (e.g., wind tower shipments). Several public agency stakeholders expressed the need for the price of permits to reflect the impact of the permitted load on infrastructure as well as the cost of the permit process.
4. **Participate in the AASHTO discussion with the Federal government concerning weight limits on the national Interstate Highway Network.** AASHTO's recently adopted Authorization Policy recommends that "states, in collaboration with the freight transportation industry and the Federal government, should investigate the feasibility of regional adjustments in truck size and weight in particular corridors that demonstrate important economic benefits and meet safety, pavement/bridge impact and financing criteria."
5. **Conduct a comprehensive review of the State's capacity to enforce TSW laws.** The safety of the traveling public and the preservation of the State's highway infrastructure are the Department of Transportation's highest priorities. Enforcing the States' TSW laws is key to achieving these priorities.

According to the 2009 State Enforcement Plan, Wisconsin's size and weight enforcement resources are heavily focused on U.S. and Interstate highways, leaving minimal resources for enforcement on secondary and rural roadways. This review will assess the Patrol's capacity to meet its responsibility for TSW enforcement and local officer training. In addition, the study will explore ways to reduce violations through expanded educational programs such as the one recently initiated by the Center for Transportation Studies at the University of Minnesota. This training promotes voluntary compliance to significantly reduce the damage to public roads caused by overweight vehicles.



# 9.0 Wisconsin TSW Policy Implementation Guidance

## 9.1 OVERVIEW

The technical memorandum is intended to provide guidance to WisDOT on potential modifications or updates to truck size and weight (TSW)-related processes, procedures, and technologies. Findings of the Wisconsin TSW Study highlighted the challenges facing the three following areas of WisDOT management:

- Oversize/Overweight Permitting Procedures;
- Safety and Weight Enforcement Facility Inspection Technologies; and
- Commercial Vehicle Information Systems and Networks (CVISN).

This technical memorandum identifies national best practices appropriate to WisDOT delivery of TSW programs, potential future directions in program adoption for WisDOT, and lessons learned and barriers to implementation for the identified directions. The memo will address three key questions:

1. What are the national best practices in each of the key TSW management areas?
2. Which practices match with WisDOT's needs and opportunities?
3. What "lessons learned" and barriers to implementation should WisDOT be aware of as the agency considers advancing TSW programs?

## 9.2 OVERSIZE/OVERWEIGHT PERMITTING PROCEDURES

WisDOT has expressed interest in innovative approaches to OS/OW permitting which would enable the Department to keep up with growing demand for larger and heavier vehicles while protecting Wisconsin's infrastructure and the safety of all roadway users. This preliminary best practices analysis is primarily focused on three areas, all of which have been adopted by other states in order to increase efficiency to keep pace with permit demand.

### Best Practices

#### *Regional Permitting*

State DOTs can effectively share the burden of OS/OW permit approval and issuance with neighboring states or states within a defined region. Through

identification of envelope vehicles and routes, state DOTs give their neighbors permission to issue permits on their behalf. A truck meeting the requirements of several states can receive a single OS/OW permit that allows them to operate legally for the length of a predefined, multistate trip.

Some multistate organizations such as the Western Association of State Highway and Transportation Officials (WASHTO), the New England Transportation Consortium (NETC), and the Southeastern Association of State Highway and Transportation Officials (SASHTO) currently operate regional permitting programs. Some of the positives include sharing the burden of permit issuance and increasing efficiency for shippers, haulers, and permit reviewers. Some of the negatives include difficulties in coordination and loss of flexibility.

**Figure 9.1 Western Permit Program States**



The Western Regional Permitting Program run by WASHTO includes Arizona, Idaho, Montana, Oregon, Utah, Washington, Texas, New Mexico, Colorado, Oklahoma, Louisiana, and Nevada. They have a centralized fee collection program and each state has the ability to issue permits for all states within a Predefined Regional Network for vehicles that fit a size/weight envelope. The maximum allowable size dimensions are 14 feet wide, 14 feet tall, and 110 feet long. The maximum GVW is 160,000 pounds with additional axle and axle-grouping weight limits.

### *Corridor-Based Permitting*

One of the findings of the Wisconsin TSW Study was the difficulty of meeting the demand for permit requests while protecting vulnerable bridges. Corridor-based permitting can increase OS/OW permit issuance efficiency while protecting vulnerable infrastructure and routing heavy freight traffic onto the facilities and routes best suited to handle it. By developing envelopes for vehicle size and

weight and applying them to specific route networks, state DOTs are able to issue intrastate permits with minimal review resources.

One of the early adopters of corridor-based permitting is the Tennessee DOT (TDOT). The TDOT program began in 1998 and is currently undergoing a major upgrade. Originally, 600 routes were identified for inclusion in the envelope network. The origins and destinations of these routes include features such as state borders, city borders, and points of interest such as the General Motors/Saturn plant in Spring Hill. Program engineers have estimated that their permit processing time has gone from an average of 30 minutes to 3 minutes. A recent sample of 231,000 permits issued in 2007 and 2008 showed that 77 percent of OS/OW permits were issued on envelope routes.

Some of the advantages of corridor-based permitting, as listed in the *Results of the Year 14 Oversize/Overweight Permitting Project*,<sup>65</sup> include:

- Incremental Implementation;
- Suitability for Interstate Traffic;
- Suitability for Regional Permit Agreements;
- OS/OW Permit Customers Know Their Routes;
- Envelope Routes Provide a Market Force to Move Traffic onto the Routes the Agency Prefers;
- Integration with External Legacy Systems; and
- Lower Implementation Cost.

However, corridor-based permitting does have the downsides of requiring significant research for corridor development (including identification of vulnerable structures) and being more effective for recurring and interstate traffic than for industries that require diversified travel patterns such as timber and agriculture.

### *Performance-Based Permitting*

Performance-based permitting is one element of a performance-based system of TSW laws and administration. Performance-based TSW standards are currently employed in countries such as Canada and Australia. Vehicles are regulated based on their ability to meet certain performance standards (such as the ability to make operational moves safely and consistently) rather than on limits such as weight, weight by axle, or overall length. The approach is meant to improve efficiency and safety of the freight system by encouraging operators to choose efficient and safe equipment and operating practice.

---

<sup>65</sup>*Results of the Year 14 Oversize/Overweight Permitting Project*, developed by Cambridge Systematics, Inc. for the Federal Highway Administration and the I-95 Corridor Coalition.

Canada currently offers special permits to operators that meet a high level of performance standards. By using OS/OW permits as a reward for meeting certain standards, which can include such elements as safety and compliance history, vehicle equipment requirements, and vehicle configuration, administrators create an incentive for safe, efficient operation.

Performance-based permitting is an important tool for DOTs to be aware of moving forward. There is greater detail on performance-based standards in Section 10.

## **Opportunities for WisDOT**

WisDOT is moving forward in the area of regional permitting. The first step in the process is coordination with Minnesota DOT (MnDOT) as part of a broader bi-state cooperation agreement. Staff from both agencies will be cross-trained in the systems and processes of the other. Given the differences in systems, management protocols will be put into place to ensure that the relative proportion of workload between the two agencies' staff will remain roughly similar to the pre-agreement workload. This approach would be true bi-state permitting, where staff from one agency would be able to access the systems of both agencies simultaneously for any kind of permit, not just a standardized envelope vehicle.

The concept will likely be extended over time to include additional states in the Upper Midwest in some form of multistate permitting agreement, albeit most likely for a standard envelope vehicle. A strong Wisconsin-centric agreement can be crafted by using the bi-state agreement with Minnesota as its backbone. Appropriate states and provinces would North and South Dakota, Iowa, Manitoba, and Saskatchewan to the west, and Illinois, Indiana, and Michigan to the east. An agreement between these entities would leverage OS/OW-related commerce to the entire Eastern Seaboard, as well as to the Pacific Northwest and western Canada. Any regional agreement may begin with the Mississippi Valley American Association of State Highway and Transportation Officials (AASHTO) OS/OW group, which has met several times in the past year and started discussion of regional coordination on permitting.

Standardization of a multistate permitting agreement for a standard envelope vehicle will help WisDOT because of Wisconsin's unique location on the I-90/94 corridor. It is likely that the total number of permits to be initiated with WisDOT will decrease over time, due to the border-to-border trips that would be handled by another state in the region.



## Implementation Guidance

A study on behalf of the Federal Highway Administration and the I-95 Corridor Coalition<sup>66</sup> identified four areas where Coalition members could improve both the agency and the customer experience:

- Staff Leverage;
- Seamless Compliance;
- Customer Partnership; and
- Managing Appropriate Responsiveness.

As WisDOT increases its efforts to foster a multistate regional permitting environment in the Upper Midwest, all four of these points should be considered and managed by setting the standards which states must meet to reach various levels of participation within an agreement. While *Staff Leverage* for agencies in all states is a desired goal, and thus the easiest to manage, the other areas present particular challenges.

In *Seamless Compliance*, while the overall challenge is to continue to improve compliance processes in all participating states regardless of a multistate agreement, the specific challenge will be to identify how various systems and laws from multiple states can be blended to form a rigorous compliance environment. An analysis of rationalization of permit travel restrictions, for example, has already begun between WisDOT and MnDOT.

In *Customer Partnership*, it is imperative that the participating agencies establish a baseline standard for the expectations the group collectively has for the industry, including motor carriers and permitting services. It is likely that in some situations, states will interact with each other technically as pseudo-services. The industry will quickly learn any deficiencies in the emerging multistate process, and strong relationships with industry will be required to mitigate and resolve the deficiencies. It is important to establish an outreach program with the services and carriers, perhaps via the Specialized Carriers and Rigging Association, to explain why the multistate program is important for the industry, and how your customers' business models can be profitably adapted to the changing environment.

We recommend creating an independent web site to publicize the alliance and to serve as the focal point for outreach efforts. As more states join a regional permit alliance, it may be appropriate to include a simple on-line "wizard" that helps customers go to the right state site for their permit (most likely based on state of trip origin), and makes sure that customers understand when the multistate permit will apply.

---

<sup>66</sup>Ibid.

In *Managing Appropriate Responsiveness*, the challenge will be to get multiple states to have similar response times for standard issues. As a hypothetical, imagine that the processing time for a multistate permit from Winnipeg to Detroit averages 30 minutes, but that the processing time for a multistate permit for the return trip of Detroit to Winnipeg averages 3 hours. Standard operating procedure can never be completely standardized across the region due to each state or province's specific laws, regulations, staffing levels, and systems. Issues, however, should be captured from the partner customers, and tracked aggressively by the representatives of the participating states.

### **9.3 SAFETY AND WEIGHT ENFORCEMENT FACILITY (SWEF) INSPECTION TECHNOLOGIES**

Research into Wisconsin's TSW enforcement environment showed that, like much of the United States, Wisconsin agencies that enforce TSW laws are struggling to keep up with growing volumes of commercial trucks. Limited operational resources have prevented the State Patrol from increasing staff levels to match Wisconsin's growing commercial vehicle flows. Technologies that enable efficient and increasingly (in some cases entirely) automated enforcement have enabled TSW enforcement agencies to increase efficiency in identifying and fining violators.

Wisconsin has a large and growing network of fixed and virtual facilities and, in most respects, is on the cutting edge for roadside inspection and enforcement. Central to this network are 13 fixed Safety and Weight Enforcement Facilities (SWEFs) at the following locations:

- Dickeyville;
- Madison;
- Beloit;
- Kenosha;
- Racine;
- Wrightstown;
- Newton;
- Abrams;
- Coloma;
- West Salem;
- Hudson;
- Menomonie; and
- Superior.

Several of these sites include weigh-in-motion (WIM) capabilities. Four sites – Madison, Beloit, Hudson, and Menomonie – have mainline WIMs capable of weighing commercial vehicles at highway speeds. Wisconsin plans to install mainline WIMs at additional sites, including on the State’s heaviest travel corridor through Kenosha and Racine, and presently is evaluating load cell technology from different vendors.

The four current mainline WIM sites also serve as PrePass® electronic screening sites. Wisconsin has used PrePass since 2001 and plans to add a fifth screening site at Superior in 2010. These sites follow the standard e-screening model. Enrolled vehicles with compatible transponders are identified on the mainline. A screening algorithm that includes weight, credential information and a random pull-in factor is applied. Drivers receive either a bypass (green light) or pull-in (red light) signal via the transponder. Vehicles that are pulled in may be subject to a more rigorous inspection.

The SWEFs vary in size but the largest have the following features: indoor truck inspection facilities, trenches for undercarriage inspection, brake testing equipment and triple-deck scales for weighing an entire vehicle. They also may have 24/7 driver rest areas, break rooms, restrooms, training facilities and other customer services amenities. WisDOT’s Divisions of Transportation System Development (DTSD), State Patrol (DSP), and Business Management (DBM) share the responsibility and the cost of maintaining and operating the SWEFs. DTSD is responsible for infrastructure and repairs; DSP is responsible for inspector wages and custodial expenses; and DBM is responsible for utilities.

Wisconsin has an ongoing program to improve the SWEFs. Beginning in 2010, the Superior site will be upgraded to include two-way mainline WIMs, an improved facility in the highway median and PrePass screening. In 2012, the SWEF in West Salem will be relocated to Sparta and will be similar in design and function to the larger SWEFs located in Kenosha and Beloit. Future changes also are planned, including moving the Dickeyville facility to Dodgeville in order to cover traffic on U.S. Highway 18 as well as U.S. Highway 151.

In addition to the SWEFs, there are three pull-off sites at Verona, Plymouth, and Stiles Junction.

## **Best Practices**

### *Virtual Weigh Station Technologies*

A typical Virtual Weigh Station (VWS) will consist of a computer attached to a camera and a WIM scale. Vehicles passing the VWS are photographed and weighed. This information is published in real time to a web site. Officers can monitor the web site either from a SWEF or a patrol car using a laptop computer equipped with an aircard that provides wireless broadband network access.

When a potential violator is detected, a patrol car can use the location and description to stop the truck. If the patrol car has portable scales, a certified weight can be obtained at the roadside. Otherwise, the truck can be escorted to a

SWEF. A certified weight is necessary for any enforcement action. However, the State personnel have noted that a VWS is very good at identifying potential violators, which facilitates efficient use of limited enforcement resources.

**Figure 9.2 Virtual Weigh Station Transponder and In-Vehicle Computer**



Source: Mike Akridge, FLDOT. Overview of Florida CVISN Program. 2008 Smart Roadside Workshop.

Compared to a typical camera system that presents a photo of all or part of a vehicle, a license plate reader (LPR) or U.S. DOT number reader uses a camera system augmented with specialized optical character recognition (OCR) software to convert a photographic image to a plate or U.S. DOT number. LPRs and U.S. DOT number readers are forms of automated vehicle identification (AVI). AVI relieves the need for any kind of visual recognition, whether it is based on seeing the vehicle itself or a photo of the vehicle. The LPR or U.S. DOT reader can interface with a state's Commercial Vehicle Information Exchange Window (CVIEW) to retrieve safety and credentials information associated with the vehicle identified automatically by its license plate or U.S. DOT number. Additionally, license plates can be searched in the National Crime Information Center (NCIC) or other database or list, further expanding the screening factors. AVI deployment allows screening on safety, credentials, and criminal justice information as well as weight and can considerably reduce the time required to retrieve additional information about a suspect vehicle.

AVI technologies have the benefits of: enabling enforcement agencies to target resources towards offenders; increasing data collection abilities; and enabling inspectors to access safety, credentials, and criminal justice information in a timely manner. Some of the obstacles to widespread adoption of AVI technologies include: accuracy and privacy issues; reliance on dedicated short-range communications (DSRC); and the relatively immature state of OCR related to license plate and U.S. DOT number reading capability.

Currently, LPR and U.S. DOT number readers are active in limited areas. Florida DOT uses LPRs at weigh station ramps. The Port of Jacksonville (JaxPort) uses AVI technology to maintain security and monitor access and also communicates truck identifications and weights to enforcement officials.

## **Opportunities for WisDOT**

Wisconsin has begun to deploy VWS at locations within the State. The first two VWS were installed in 2007 along bypass routes associated with the Madison SWEF. Three additional VWS sites are under development with more planned for the future, based on the funding availability.

At least one of the new VWS installations will cover a site at Hurley on the border between Wisconsin and Michigan. This route currently is not associated with a fixed facility but may carry many overweight timber trucks. Wisconsin plans to share data on these vehicles with the Michigan State Police. Northwestern University also will use this information to study how bridges respond to the stress of overweight trucks.

At the present time, there are few ways in which Wisconsin could dramatically improve their roadside operations. The combination of the SWEFs, PrePass and the virtual weight stations gives the State superior coverage and capabilities for roadside enforcement. However, the Wisconsin VWS installations do not include license plate readers or other technology to identify the specific vehicle or carrier. Without this information, a VWS cannot check credential information in the Wisconsin CVIEW. As a result, VWS sites are used primarily for weight enforcement although the VWS also captures information such as truck speed.

The addition of AVI in the form of license plate or U.S. DOT number readers at some of the virtual weigh stations could enable the State to do broader credential screening. Currently, screening on credentials (e.g., IRP and IFTA status) for a large number of vehicles would occur only at PrePass sites. While the Wisconsin credentials data are available to PrePass, much of this process is out of the State's direct control. Also, the location of the PrePass sites means that many intrastate vehicles would never be subject to credential screening. VWS sites with license plate readers at strategic locations within the State could interface with the Wisconsin CVIEW to check a variety of credentials.

WisDOT is currently planning to investigate the use of LPRs for vehicle tracking purposes as well as AVI/credential access at the Kenosha and Racine SWEFs. This represents an excellent opportunity to test the value of these new technologies.

## **Implementation Guidance**

The main barrier to implementation will be the availability of funding to deploy, upgrade, and maintain the SWEFs and VWS installations. Certainly, these facilities provide significant value in targeting enforcement against potential violators. However, the effects of weather, heavy usage and normal wear-and-tear, means that these sites will require continual maintenance.

While the technology used to read license plates or U.S. DOT numbers on trucks has improved significantly in recent years, these devices are by no means perfect. Also, the cost to add this capability to a VWS, and maintain it, can be significant. At the present time, the return on investment may be difficult to justify.

## 9.4 COMMERCIAL VEHICLE INFORMATION SYSTEMS AND NETWORKS (CVISN)

CVISN is a program developed and managed by the Federal Motor Carrier Safety Administration (FMCSA). The goal of CVISN is to improve commercial vehicle safety and operational efficiency nationally. The CVISN program is divided into three focus areas:

1. **Safety Information Exchange** - Breaking down technical and institutional barriers that prevent information on commercial carriers and vehicles from being shared within a state and across states;
2. **Credentials Administration** - Providing motor carriers with the means to apply for and receive credentials electronically, improving efficiency both for the carriers and the state personnel responsible for these credentials; and
3. **Electronic Screening** - Using electronic information to identify carriers and target limited enforcement resources at those carriers with a history of safety problems.

FMCSA established standards in all three focus areas that a state must meet in order to be considered Core CVISN (originally CVISN Level 1)-compliant. FMCSA also provided states with grant money to execute their CVISN programs, including planning, software development and ongoing maintenance and operations. Beyond Core CVISN states also may apply for Expanded CVISN grant funding. This money can be used to enhance a state's CVISN program in a variety of ways.

Wisconsin was an early CVISN leader and has been Core CVISN compliant for several years. The state has deployed its own safety information exchange system. Within the CVISN architecture, this system is referred to as the Commercial Vehicle Information Exchange Window (CVIEW). The Wisconsin CVIEW receives and stores data such as International Registration Plan (IRP) and International Fuel Tax Agreement (IFTA) status from state systems. CVIEW exchanges these data with the national Safety and Fitness Electronic Records (SAFER) system. CVIEW also downloads IRP and IFTA data placed into SAFER by other states. The information in CVIEW is intended to support credentials administration and electronic screening.

Wisconsin currently uses the COVERS and COVERSft systems from R.L. Polk to manage their IRP and IFTA credentials, respectively. Because R.L. Polk has stated that they will discontinue support for these products in 2010, Wisconsin is in the process of replacing both systems.

Although handling of OS/OW permits is not part of the standard Core CVISN credential set, Wisconsin has deployed an OS/OW application developed by Bentley Systems. At the present time, the State is working with Bentley to correct issues with the highway network data that is preventing the automated selection of routes for heavy loads.

Finally, Wisconsin participates in the PrePass electronic screening program. PrePass is Core CVISN compliant and fulfills all of Wisconsin's requirements in this area.

### **Best Practices**

Since the inception of the CVISN program, FMCSA has been evaluating the success of solutions deployed by individual states in order to identify best practices. FMCSA has employed the Battelle Memorial Institute to analyze and document some of these practices in states with implementations that were creative, full-featured or particularly successful. The goal is to help states learn from other states how to meet particular challenges in their CVISN program. These reports may be found at:

[http://www.battelle.org/solutions/?Nav\\_Area=Tech&Nav\\_SectionID=3&Nav\\_CatID=3\\_Statistics&Nav\\_ContentKey={BD8556B7-7AD0-40B8-948E-553D88E1E0E7}](http://www.battelle.org/solutions/?Nav_Area=Tech&Nav_SectionID=3&Nav_CatID=3_Statistics&Nav_ContentKey={BD8556B7-7AD0-40B8-948E-553D88E1E0E7}).

Also, CVISN Deployment Workshops, such as the one held in Baltimore in December 2008, include presentations of solutions in different CVISN areas (e.g., electronic credentialing, electronic screening and safety information exchange). These presentations were made primarily by state CVISN personnel and were intended to provide practical information on how to address particular issues. Presentations from this workshop are available on-line at:

<http://www.fmcsa.dot.gov/facts-research/cvisn/2008-CVISN-Deployment-Workshop.htm>.

It is important to recognize that every state faces unique challenges in their CVISN program and what works in one state may not work in another. Therefore, some of the solutions documented by FMCSA may not be appropriate for Wisconsin. However, Wisconsin has been a leader in the CVISN arena, not so much because of the technical sophistication of the solutions the state has deployed, but because of the cohesion and focus of the state's CVISN team. Other states with successful CVISN implementations also have teams that are dynamic and engaged. To the extent that any one best practice can be identified for CVISN, it is to create and maintain a team that brings together all the CVISN partners, is proactive in addressing issues related to CVISN and can "make the case" for CVISN to ensure that the program receives the recognition and funding necessary to make it a success.

### **Opportunities for WisDOT**

Wisconsin is in the process of applying for their final round of CVISN grant funding. This funding can be used to support a variety of projects, including:

- Replacing the IRP and IFTA systems;
- Updating the OS/OW system;
- Maintaining CVIEW and the interface with SAFER;
- Managing and improving the SWEFs; and
- Deploying VWS installations.

A key challenge that Wisconsin is facing is how to move CVISN out of the prototype stage and onto the same level as mature programs like IRP and IFTA. CVISN programs typically are in danger of becoming stagnant after systems are deployed and when Federal grant monies no longer are available. Teams assembled within a state to run the CVISN program are broken up or people, including high-level project sponsors, retire. Personnel with less experience or investment in CVISN struggle to find justification for continuing the program. Unlike IRP and IFTA, which generate their own revenue, the benefits of CVISN are less tangible and CVISN no longer has a high-profile national presence.

Wisconsin is not unique in facing the challenge of mainstreaming CVISN. In 2009, FMCSA intends to provide guidance, in the form of webinars and other materials, to help states with this issue. However, there will be no magic solutions. FMCSA cannot, and never intended to, provide CVISN funding forever. It will be up to individual states to enumerate the values that CVISN provides.

Bringing CVISN into the mainstream will help Wisconsin consolidate gains, both in updated processes and technologies, made in recent years. These changes will help increase safety and security on Wisconsin roads and allow CVISN agencies, including roadside enforcement, do more with less. CVISN already is helping enforcement identify and target roadside violators. In addition, improvements over the next two years should help state personnel process commercial vehicle applications and permits more efficiently.

### **Implementation Guidance**

For a CVISN program to flourish, a state generally needs a strong team with ties to all aspects of CVISN (e.g., credentialing, information technology and enforcement) as well as a project sponsor that can support CVISN efforts. Wisconsin already has a team in place but has lost a great deal of continuity with the original CVISN planners. This team may need to focus on relearning many aspects of CVISN and on educating other users and agencies about the capabilities and advantages of CVISN.

In addition to the team, a CVISN program needs a source of funding beyond FMCSA grants. Wisconsin presently is maintaining many CVISN systems but it is not clear that some systems, such as CVIEW, have the necessary long-range financial and technical support. Every CVISN system should be adopted by one or more agencies or divisions who will be responsible for maintaining the system, including any interfaces to other systems. Where multiple agencies or



divisions share this responsibility, memoranda of understanding should be developed that lay out specific financial and technical obligations.

The success of Wisconsin's roadside operations should be a key factor in justifying the cost of CVISN. Much already has been achieved at the SWEFs and through the virtual weigh stations and more can be achieved provided funding and other issues can be addressed.

Finally, CVISN continues to evolve at the Federal level and individual states must have a plan for keeping abreast of these changes and updating state systems to match. Regular attendance on conference calls and participation in webinars and other forums will allow Wisconsin to leverage the collective wisdom of CVISN users and participants nationally. The challenge will be to identify Wisconsin personnel responsible for fulfilling this role and ensuring that these people have the time not only to gather information related to CVISN but to share this information with other interested parties.



# 10.0 Performance Measures and Devices for Keeping Rules Current

## 10.1 INTRODUCTION

The charge of this task of the Wisconsin Truck Size and Weight Study was to evaluate performance measures as a method of keeping size and weight regulations current. As the study progressed, it became apparent that this charge was too narrow to produce the desired outcome. Therefore, the study parameters were reframed. The result is Section 10, which looks first at the objectives of moving freight, suggesting a range of measures and a process for settling upon a group of measures that might have meaning to both the agency and the trucking industry. These measures should provide a basis for ongoing discussion between the Department and the trucking industry and should provide an understanding of how the state highway infrastructure is meeting the needs of the freight-moving industries.

This section discusses methods and devices for listening to the industry. The efforts and experiences of other states are discussed to provide options for better gaining the input of the trucking and broader freight industries in the state. Effective listening is essential since the needs and interests of the industry must be understood and considered as rules are refined.

Agency organization is discussed under the premise that effective listening on the part of the agency requires an organized approach to issues related to freight. Again, the efforts and experiences of other states are reviewed and some suggestions of approaches to organization are offered.

Since some other nations have moved away from prescriptive size and weight rules to rules that rely on the performance of the vehicle, the practices of those countries is discussed. The suggestion is made that those efforts be monitored, particularly the efforts of Canada, as they develop.

Some ideas are offered for adopting practices that would allow the State to respond to reasonable requests for variances in the size and weight rules, requests that would be of economic benefit to state industries and result in safe vehicles doing little additional damage to highways and bridges.

These several efforts, finding measures that reflect what is important to the agency and the industry, taking steps to better listen to the freight industry, better organizing to deal with freight issues, monitoring alternative approaches in other countries and taking an active approach to meeting reasonable requests

for variances, should allow the state to keep its size and weight rules current, meeting the needs of commerce and of the traveling public.

Finally, the ongoing efforts of WisDOT to adopt some of the suggested measures are discussed.

## 10.2 OVERVIEW

Truck size and weight regulations can be among the more contentious issues in transportation policy. Economic viability depends upon the efficient movement of freight, but heavy trucks can do serious damage to highways and bridges. Larger trucks should mean fewer trucks, which would relieve some congestion, but larger trucks are widely viewed as inherently more dangerous to the auto driver. Resolving these competing positions is a major challenge. Wisconsin has recently completed a thorough study of vehicle size and weight. This report is intended to offer ideas on how existing or revised size and weight laws can be kept current without inflaming the passions of those who hold strong views on the issues.

Balancing all of the competing positions while inflaming none will require a transparent, rational, databased decision process. It will also require clearly articulated, understood, and supported objectives.

The overall objective of rules that govern truck size and weight should be to promote the safe and efficient movement of freight in an environment that promotes a level playing field for Wisconsin-based businesses and truckers. The challenges will be reducing these broad objectives to clearly defined measures and designing processes that allow the State to pursue those objectives.

To better understand the issues and the environment and to formulate recommendations a number of interviews were done with officials of the department of transportation other state departments of transportation, shippers, and truckers. A full listing of interview participants can be found at the end of the report. To this was added knowledge of the practices of other states, particularly in the Mississippi Valley Conference, and of national research.

Through this process a number of recommendations or conclusions were developed:

1. The State does a good job of reaching out to the trucking industry on a fairly narrow range of issues through the Motor Carrier Advisory Committee, which is staffed by the DMV, but used by various interests in the department. A broader effort is needed to better understand the business needs of both shippers and carriers.
2. The current organization of the Department does not provide the required focus on or coordination of issues related to freight. Some method must be found to clarify the focus and improve coordination.

3. The Department should develop a process for developing and gaining support for a series of performance measures that will facilitate a more data-driven approach to managing size and weight issues.
4. The Department should develop method through which reasonable requests for variations to the size and weight rules can be evaluated and acted upon.

### **10.3 OBJECTIVES OF MOVING FREIGHT**

A question posed to nearly all of the people interviewed was: What is important to you and your organization in the movement of freight? The answers were somewhat surprising. Efficiency and safety were the two responses given most often. Even these tend to fuse in some in some cases, as in: The impact of large trucks on traffic flow. Since an adverse impact on traffic flow would reduce the speed of travel and impair safety, the response really captured both. In other cases, the efficiency response was very clear. Shippers cited the cost involved in having to reload shipments coming into the State either because of container limits or because of differing weight limits in other states. Some urged the reciprocity agreements be extended to allow loads from other states to reach key destinations without reloading.

Treating containers as nondivisible loads was also suggested as a way of increasing efficiency. Several shippers noted the needs for a level playing field. In some cases, that need was cited in relationship to reciprocity - or lack - with Michigan. The circumstance noted was that Michigan has stricter axle loading standards than Wisconsin. Therefore, a Wisconsin trucker could be legal west of the border and illegal east of the border, even though Michigan has much higher gross vehicle weight limits. In other cases, the level playing field was noted because of the advantage found by some truckers who violate weight laws, which leaves those who comply at a disadvantage.

If these three objectives - efficiency, safety and a level playing field - are used to develop measures, several useful measures might be found for which data is available.

**Figure 10.1 Inventory and Transportation Costs**

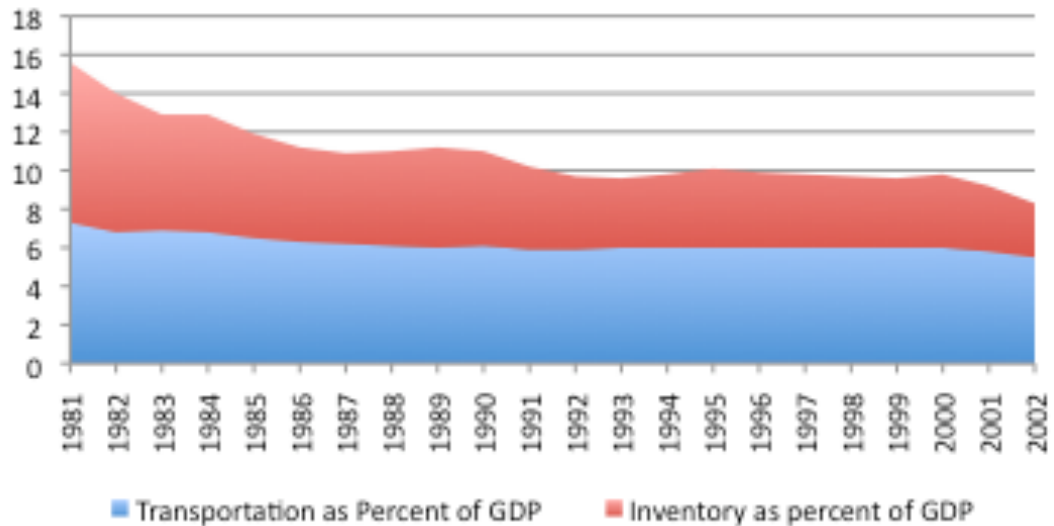

1. Transportation and inventory as a percent of state GDP. This is a fairly standard measure of freight efficiency. Both inventory and transportation must be used since they are alternative costs in logistics. Lower percentages of the economy devoted to them will allow more resources to be invested in other areas. Lower costs for these items in Wisconsin relative to other states will provide a competitive advantage for the State. The graphic illustrates the trend line measure using national data. This must be seen as a very long-term measure.
2. Transit time between key in-state destinations and variance in that transit time. Time and reliability are two key ingredients in freight efficiency. Time of transit and variance in time of transit over years will provide measures of progress in the improvement of freight transportation in the State. The destination points should be chosen to cover the major state corridors. For a start the following could be considered:
  - a. Green-Bay - Milwaukee;
  - b. Eau Claire - Green Bay;
  - c. Hudson - Beloit;
  - d. Madison - Wausau;
  - e. Superior - Eau Claire;
  - f. Ashland - Wausau; and
  - g. Milwaukee - Beloit.

At this point, a ready information source is not available, short of using pilot cars, but efforts by the FHWA to capture and use information from truck-based mobile communications systems to gauge transit time will likely produce usable data in the near future.

3. Variations in rules with neighboring states. A good measure of a level playing field is how well Wisconsin size and weight rules mesh with those of nearby states. This is often done at a fairly high level: Michigan allows heavier loads than Wisconsin. While this is useful information, some of the comments received from truckers suggest that it would be more useful to dig deeper, looking at issues like axle limits, vehicle configuration, and reciprocity, to determine true compatibility. This information could be updated periodically with a few calls or a check of web sites.
4. Number of large truck-involved crashes. Truck safety is as much about perception as reality. Therefore, any measure of safety should be kept simple. The number of crashes in which a large truck is involved is the simplest measure. Issues of fault or severity only complicate matters. Crash rates may be useful for some purposes, but, for an overall measure of safety that can be understood beyond the professional ranks, absolute numbers are best.
5. Number of legislated special provisions. Over the years, the state legislature has passed a number of special weight laws for specific business groups. The fact of legislated special provisions could be seen as a demonstration that the weight laws are not keeping pace with changing business conditions. It can also be seen as an argument that administrative options are not available to businesses that seek accommodations for truck weight. Therefore, keeping track of the number of exceptions provided over time can be a gauge of the health of the weight rules and processes.
6. Number of violations. As noted previously, some shippers noted that truckers and shippers who violated weight laws had an advantage over those who complied with the laws. Measuring the amount of true violation is difficult – how do you know how many violators are not being caught, if they are not being caught? An approach is tracking the number of violations cited by enforcement people over time. This measure will have to be used with a couple of key assumptions: Enforcement policies and budgets are consistent over time. A steady proportion of violators are being ticketed. If these assumptions are correct an upward trend in ticketed violations would suggest an increase in total violators. If the assumptions prove to be incorrect, the data could be very misleading.

The suggested measures, if updated and published regularly, would provide a basis for discussion with private industry to keep the weight rules current. They might also serve as a small indicator of the health of the state highway transportation system as it relates to freight.

Using this small group of measures would place Wisconsin in good company nationally. Minnesota has done more than other states in the use of performance measures for freight transportation. Staff at MnDOT would readily admit that their efforts to date are inadequate. MnDOT's group of truck freight measures compares favorably with those suggested:

- Miles of roadway in good or poor condition;
- Time to clear freeway incidents;
- Truck traffic generators with appropriate access to major corridors;
- Peak-period travel time reliability;
- Ratio of peak to off-peak travel time;
- Heavy truck crash rates; and
- Heavy truck fatalities.

Like the measures suggested for Wisconsin, MnDOT's approach provides some measure of the health of the highway system for trucking. It does not attempt to address the specific question of the currency of weight laws, but the measures could provide a useful basis for discussion with the private sector on this and other trucking issues. That basis would be much stronger if the industry bought into the measures used and agreed that they were appropriate. For that reason, the WisDOT should develop specific measure in a forum in which the private sector has input. Those suggested might serve as a starting point, but they may be adjusted based in input received.

## 10.4 LISTENING TO THE INDUSTRY

The currency and appropriateness of size and weight laws is determined by how they are perceived by constituent groups outside of the agency, groups they were designed to serve and protect. One such group is the freight shipping and carrying community. A challenge that many states are now attempting to address is developing the processes needed to interact effectively with that community.

One frequently used device is a freight advisory committee. Minnesota is a leading example; Oregon is another; and Indiana is a third. Each takes a different approach to the issue. Minnesota has a multimodal advisory committee. It was created by the Commissioner of Transportation and has been in existence for a number of years. The group meets quarterly and provides advice and direction to the agency on issues related to freight. It also partners with the University of Minnesota and state logistics professional association to hold annual freight workshops. Perhaps its strongest role is in providing advice to the agency on pending state and Federal legislative proposals. The group is comprised purely of volunteers. For this reason, it requires staff support from the agency and is asked to meet no more than quarterly and then for only one-half day.

Oregon's freight board is a product of state statute. It nominally has many of the same responsibilities as Minnesota's committee with a very notable addition. It is also charged with prioritizing proposals for funding under a grant program for freight improvement projects. This project ranking and fund allocation function



gives the board a much stronger reason for existence. It also enhances the influence it holds.

Indiana has taken a different approach. It uses the transportation subcommittee of an organization called Conexus Indiana. Conexus is a partnership of government, industry, and academia dedicated to promoting the business climate in Indiana. Its Executive Committee illustrates the strength of the organization:

- VP for Research, Professor, Dept of Aerospace and Mechanical Engineering;
- University of Notre Dame;
- President and CEO, Conexus Indiana;
- Chief Operating Officer (retired), Rolls-Royce Corporation;
- Co-Chief Operating Officer and President, Brightpoint Americas;
- President and CEO, Koch Enterprises, Inc.;
- President and Owner, Langham Logistics, Inc.;
- Vice Provost for Engagement, Purdue University;
- President and COO, Cummins, Inc.;
- President and CEO, Central Indiana Corporate Partnership;
- Chairman and CEO, Duke Realty;
- Vice President, FedEx Express;
- President, Ivy Tech Community College; and
- President of Toyota Industrial Equipment Manufacturing, Inc.

While not all of the Executive Committee takes part in the transportation subcommittee, the titles listed demonstrate the commitment of senior people, influence leaders and decision-makers, who take part in Conexus.

The commitment of such senior people is one of the ingredients that will determine the success of an advisory committee. Too often participation is delegated to lower-level people who may be knowledgeable, but who lack the influence of more senior personnel. The experience of others suggests a few features that might help to attract senior people from private industry:

- A realistic and modest time commitment. As noted from the Minnesota experience, four hours per quarter is about the maximum that can be asked of volunteers.
- Meaningful agendas. Since Conexus has a broader portfolio of interests than might be found in other agency advisory committees, people are willing to spend the time required. In the case of Oregon, allocating funds and advising the Governor and the Legislature add importance to the tasks. In Minnesota, the opportunity to comment on pending legislation and to

partner with others for annual workshops all help to elevate the significance of the activity.

- Participation of senior agency people. In Minnesota, participation at what Wisconsin would describe as the division-level is common. The Oregon board serves at the request of the Governor and make recommendations to the Governor and the Legislature.

An advisory committee can serve a very useful purpose. It can be particularly useful in engaging members of the private sector in policy and legislative debates, but it is not the only tool needed to listen to the industry. The Director of Freight for the Washington DOT, a state that is usually recognized as one of the leaders in freight, has offered the opinion that nothing can substitute for face-to-face contact with freight leaders in their offices. That face-to-face contact begins to give the agency person legitimacy in the freight arena. It also gives the private sector person the opportunity to express views while not in the company of potential competitors. Finally, it gives the agency people the opportunity to sample a broader array of interests. In the case of Washington, seven very distinctive economic regions have been identified, each with shippers and carriers with unique perspectives on the freight industry. It would be very unusual, even with the largest committee possible, to get a true representation of the state industries through a single advisory committee.

Tools can be found between freight advisory committees and one-on-one meetings. Wisconsin has a large number of industry groups dedicated in whole or part to freight transportation activities. The WMC, MMAC, WMCA are some of the acronyms that come to mind. In addition, groups representing the dairy and produce industries or the logging and paper industries all have transportation interests and could be reached out to as a source of input. Those listed are at best illustrative. Several times this number are available and could be used.

Doing outreach requires the dedication of personnel. Committees must be staffed and time must be made available for meetings either with individuals or with groups. In Washington the Director and at least one other person spend much of their time reaching out to industry. In Minnesota a substantial portion of one staff position is dedicated to staffing the advisory committee. It cannot get done if assigned simply as another collateral duty. Dedicated time is required.

## 10.5 AGENCY ORGANIZATION

Doing any of the things suggested in this paper will require a well organized agency, both in terms of the boxes on the organizational chart and in terms of the alignment of the activities that occur within those boxes. The following organizational chart of WisDOT illustrates the challenge. All those boxes with arrows pointing to them have a role in freight.

Figure 10.2 Wisconsin DOT Organizational Structure

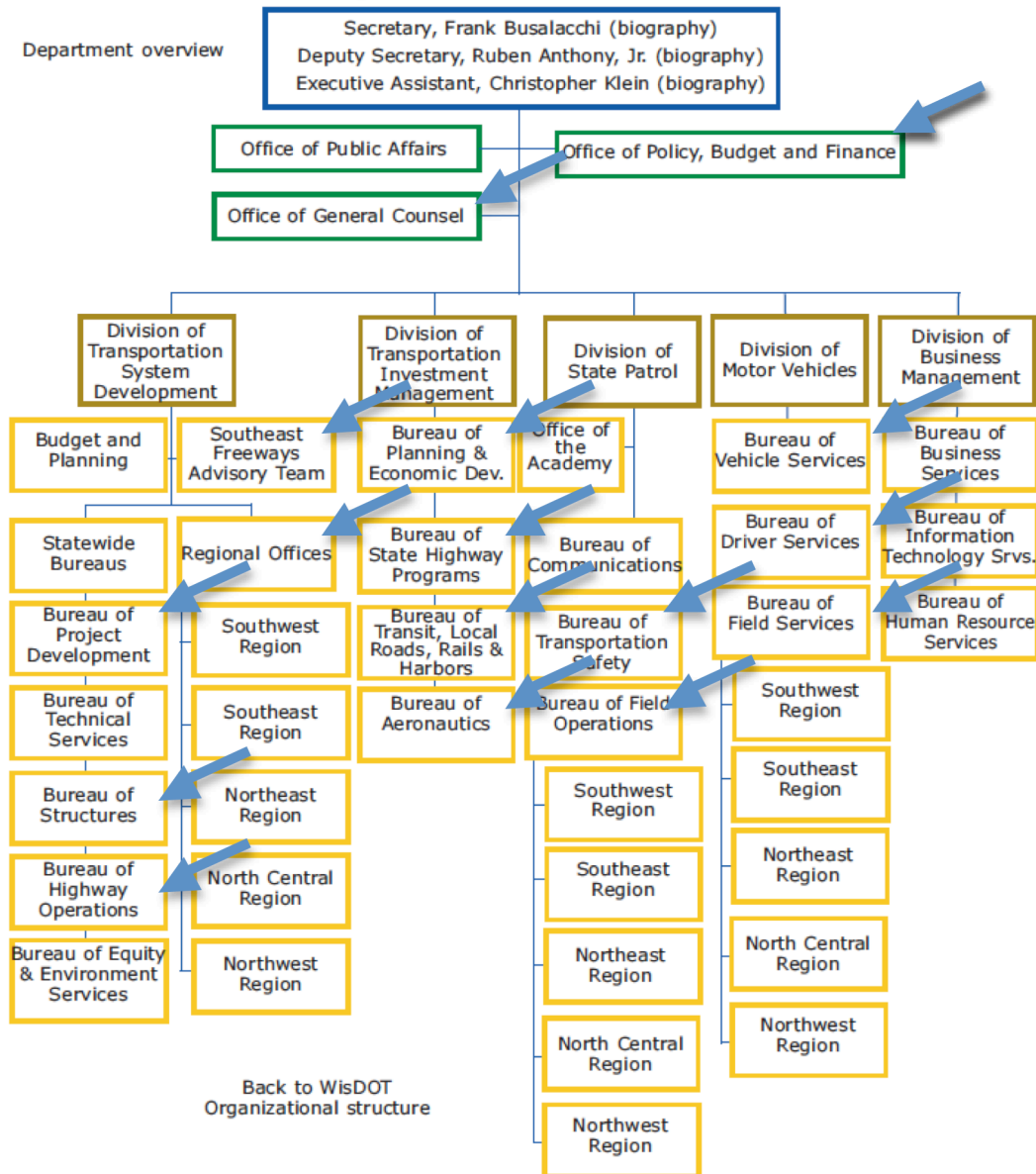

Source: [www.dot.wisconsin.gov/about/docs/orgchart.pdf](http://www.dot.wisconsin.gov/about/docs/orgchart.pdf).

At least 20 bureau-level organizations have some role, including two Executive Offices, three engineering bureaus, all the regional offices, all the bureaus of DTIM, two of three DSP bureaus and all DMV bureaus. Some have a stronger role than others. For example, the motor carrier functions of the Bureau of Vehicle Services give it a prominent role. DTIM's roles in rail, harbors, aeronautics, highway programming, economic development and long-range planning give it multiple and important roles.

When asked about method available for coordinating these several organizations, DOT staff frequently used the term "virtual" organization. This

implies an organization that communicates easily and recognizes multiple and interrelated roles. Unfortunately, it could also mean an organization in which virtually no one accepts responsibility for leading and coordinating freight issues.

One mechanism that has been discussed in WisDOT as a tool to promote the virtual organization is an internal coordinating committee. Such a committee would have representatives from each concerned organization and meet regularly to share information and formulate directions. This model is working in MoDOT, but it is more than virtual. The following is MoDOT's freight organizational chart.

**Figure 10.3 Missouri DOT Multimodal Organizational Structure**

**MoDOT Multimodal Organizational Structure**

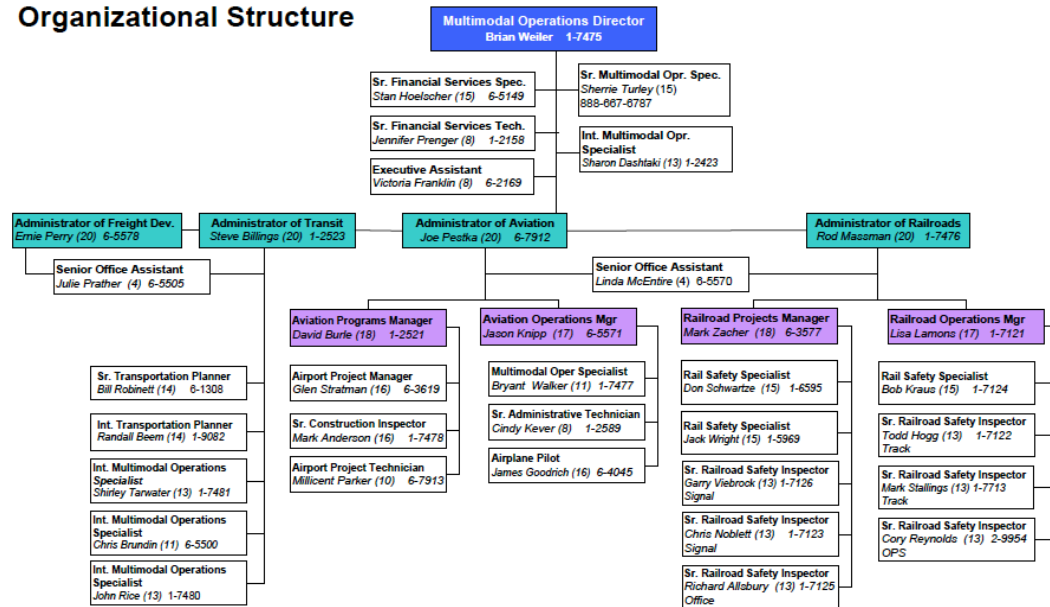

Obviously all of the nonhighway freight modes are represented in this single organization. The key position for this discussion is the Administrator of Freight Development. (Note that in MoDOT this position is analogous to a section chief in WisDOT.) This person's role is to facilitate the process of internal and external coordination. MoDOT has a coordinating committee, made up of all of the organizations shown on the WisDOT chart (MoDOT does not include all motor vehicle or state patrol functions) has having a freight role. The departments of economic development, natural resources, and agriculture are also represented. All of those external agencies also have committees with some interest in freight. MoDOT is an active participant in those committees. In fact, those other agency committees provide MoDOT access to many private freight interests. MoDOT also includes representatives of their more populous regional offices. The Administrator of Freight Development serves as the staff to this coordinating committee.

The coordinating committee is but one approach to aligning the organizations of an agency as it deals with freight. Washington DOT has taken the approach of identifying significant processes that should be influenced if freight is to be dealt with appropriately. The list of areas to be influenced was reviewed and approved by the agency head, giving freight staff legitimacy to work with the owners of those areas or processes to incorporate freight perspectives. One such area was major project development. The primary objective in this area is to ensure that reasonable and consistent analysis is done of current and potential freight traffic and the impact of the project on businesses. Another area is roadway design. The objective in this case is to supplement design manual procedures to provide enhanced intersection or interchange designs and other geometric improvements on routes with significant truck traffic.

Minnesota has taken a somewhat similar approach, although they seem not to have formalized it with the blessing of the Commissioner. Minnesota has identified key steps that should be taken to integrate freight into all department activities. A short list of these actions follows:

- Form public-public partnerships with involved agencies;
- Pursue public-private partnering opportunities;
- Develop freight criteria for project ranking;
- Provide freight input into some studies;
- Ensure freight input into policy discussions;
- Broaden truck-related data collection;
- Identify major truck crash locations; and
- Consider tonnage and value in updating Interregional Corridors (similar to Wisconsin's Corridors 2020).

The goal in both Washington and Minnesota is to integrate freight thinking and freight issues into the everyday operations of the agency. Both would agree that they have a way to go before that is a reality.

Whatever the approach taken, the goal should be the alignment of the various parts of the agency to ensure consistent and reasonable actions in matters related to freight, the sharing of information on freight and the development and execution of a freight agenda. To bring this about, some consideration may be given to a hybrid approach. Some coordinating device is clearly needed, but incorporating freight issues into everyday actions is also needed. One approach would be to establish a coordinating committee and charge it with developing a specific list of actions that are needed to bring freight into agency processes, defining their version of the list shown above.

Whatever approach is taken, some staff commitment will have to be explicitly made. A position similar to MoDOT's Administrator of Freight Development is a minimal requirement.

Another advantage of identifying a position as the freight leader is to make the role clear to external constituencies. If a shipper has an issue with the agency that does not fit neatly into existing procedures such as permitting, and if that person is not intimately familiar with the agency, whom would they call? Having a position on the organizational chart with a freight title could be a help. One of the responsibilities assigned to the position would be to know the organization well enough to be able to get customers to the right office.

A web page can also help the customer. The following is the home page of Maryland DOT's Logistics Office. Many of the functions shown on the page belong to other parts of the agency, but the page directs customers to the right location and provides at least the impression of a coordinated approach to freight.

Figure 10.4 Maryland DOT Logistics Office Home Page

**Office of Freight Logistics**

Welcome to the Maryland Department of Transportation's (MDOT) web page for the Office Freight Logistics (OFL). It is MDOT's goal to provide transportation programs and services that support freight logistics.





Freight in all forms via all modes must travel across and through Maryland in an efficient way to help grow our economy. Goods movement is critical to all business sectors, from health care, biotech, and service businesses to agri-business, manufacturing, and distribution. In addition to needing a healthy domestic freight network, our global presence is dependent on the Port of Baltimore and BWI Airport to move international cargo rapidly through the supply chain.

A balanced freight transportation system is of the utmost importance to OFL. We establish policies that will improve operating efficiencies, promote safe and reliable mobility, and advance initiatives to mitigate climate impacts. From water to rail to trucks and the "last mile" delivery, our goal is to help freight move efficiently and for the best value. For expedited deliveries, such as electronics, pharmaceuticals, and express packages, there is no faster mode than air.

MDOT is a partner in freight services, as the owner of the Port of Baltimore and several shortline rail lines, though our cooperation with Class I railroads, and by our safety initiatives and congestion mitigation efforts on Maryland highways. We work with stakeholders on initiatives to identify and improve freight movement. We are developing a Statewide Freight Plan and a State Rail Plan, planning for a freight summit in 2009, coordinating efforts to identify and build truck parking facilities, and advocating for freight through outreach to economic and land use organizations.

Maryland is located in one of the most congested areas in the country, and studies show that freight in our region could grow between 80 to 85 percent by 2030. Freight movement is a national concern, and for that reason, OFL represents Maryland on committees that explore better freight mobility, innovative financing, sustainability, and stewardship.

[Delmarva Rail Summit – March 2, 2009, Salisbury MD](#)

	<a href="#">Maryland Motor Carrier Program</a>
	<a href="#">Freight Rail Service</a>
	<a href="#">BWI Cargo Services</a>
	<a href="#">Maryland Port Administration / Port of Baltimore</a>
	<p><b>Maps:</b></p> <p><a href="#">State Highway Maps - including the Truckers Map</a></p> <p><a href="#">Port of Baltimore Trucker's Guide</a></p> <p><a href="#">BWI Airport Air Cargo Directory</a></p>

[Maryland Freight Planning](#)

[Other Freight Links](#)

[Doing Business in Maryland](#)

[Maryland Statewide Freight Summit -- Coming in 2009](#)

Contact: Caitlin Hughes Rayman  
 Assistant Secretary for Transportation Policy  
 410-885-1228

Source: [www.mdot.state.md.us/OfficeofFreightLogistics](http://www.mdot.state.md.us/OfficeofFreightLogistics).

## 10.6 PERFORMANCE-BASED STANDARDS IN OTHER COUNTRIES

All countries do not follow the same prescriptive approach to truck size and weight as the USA. Australia, New Zealand, Canada, and many European countries use some form of performance-based standards.

Rather than having generic prescriptive regulatory standards applied to all vehicles, not dependent on performance, performance-based standards offer an alternative. Performance-based standards for truck size and weight regulation are independent of vehicle components that determine the overall vehicle's impact.

A 2002 Transportation Research Board (TRB) report articulates the concept of performance-based (PB) regulatory standards well when it says that the standards, "would directly limit the behavior of vehicles instead of limiting dimensions or requiring specific equipment or appurtenances." With performance-based standards, vehicles are regulated based on their ability to meet certain performance standards rather than on specific components of the vehicle that determine their ability to meet the standard, and are often used with improved enforcement practices. They take into account not only how vehicles perform, but also how they are operated, and characteristics of the road network. The performance-based approach is meant to improve overall efficiency and safety of the freight system by encouraging operators to choose efficient and safe equipment and operating practices.

Australia's Transport Ministers approved a set of PB standards in October 2007 as part of the Council of Australian Governments' national reform agenda for transport. The PB standards are summarized in Table 10.1. The PB standards system in Australia is voluntary and meant to give operators who choose to participate an advantage over competition through more flexibility in vehicle design, increasing productivity and safety.

Each of these PB standards for infrastructure has specific requirements that detail physical characteristics of the vehicles themselves. The safety-related PB standards use test criteria and test conditions, procedures, and methods differentiated into road class that must be met to satisfy the standards. In the Australian model threshold limits are established for the performance measures to define the boundary between acceptable and unacceptable performance. These thresholds depend on the capacity and characteristics of the road on which the vehicles are operating. PB standards require a higher level of safety from the vehicles they regulate. PB standards also require that vehicles cause no more road or bridge wear than vehicles under prescriptive standards.



**Table 10.1 Performance-Based Standards**

<b>Performance-Based Standards</b>	
<b><i>Safety-Based</i></b>	Startability
	Gradeability
	Acceleration Capability
	Overtaking Provision [reserved]
	Tracking Ability on a Straight Path
	Ride Quality (Driver Comfort)
	Low-Speed Swept Path
	Frontal Swing
	Tail Swing
	Steer-Tire Friction Demand
	Static Rollover Threshold
	Rearward Amplification
	High-Speed Transient Offtracking
	Yaw Damping Coefficient
Handling Quality (Understeer/Oversteer)	
Directional Stability Under Braking	
<b><i>Pavement-Based</i></b>	Pavement Horizontal Loading
	Pavement Vertical Loading
	Tire Contact Pressure Distribution
	Bridge Loading

According to the OECD, the Australia approach of voluntary performance-based standards system is the ideal approach. Performance-based standards are developed in a staged approach, and are used for updating prescriptive standards, assessing future permits, and assessing exemptions, all dependent on specific route and road characteristics.

Like Australia, New Zealand was one of the first countries to implement performance-based truck size and weight standards, first developed to meet the needs of the country's dairy industry. Performance-based regulations are combined with prescriptive regulations to control vehicle safety and stability in New Zealand. Increased safety and stability of vehicles has resulted.

In Canada, performance-based standards have been used for determining exemptions to truck size and weight regulations. Work has been done to identify the desired freight truck size and weight performance outcomes in the different

provinces of Canada, and performance measures have been developed that help shape prescriptive regulations. The standards have not been formally adopted for regulation of truck size and weight dimensions, but the standards include:

- Offtracking;
- Static roll threshold;
- Braking efficiency;
- Friction demand;
- Rearward amplification; and
- Swing-out.

Several implementation issues must be recognized when implementing performance-based truck size and weight standards, including public perception, political, institutional, harmonization, fleet impacts, and enforcement. Enforcement, in particular, may be made more complex by PB standards.

In a paper for the 2006 Transportation Research Board annual meeting, Fekpe et al. outline the necessary characteristics of a PB standards system with the potential for implementation in the United States. The recommended PB standards are divided into two categories: those related to safety, and those related to infrastructure preservation and protection. Fekpe et al. indicate rollover threshold and load transfer ratio as the most important safety performance measures to include in a PB standard system. The authors further note that load transfer ratio is correlated with rearward amplification and is particularly important to monitor in multicomination vehicles and in congested, high-speed traffic areas where the risks are greater. Outboard offtracking response in a steady turn is also deemed an important safety-based performance standard. Table 10.2 outlines the suggested safety PB standards and their thresholds:

**Table 10.2 Safety Performance-Based Standards and Thresholds**

<b>Performance Measures</b>	<b>Criteria</b>
Static Rollover Threshold	Greater than 0.35 g
Rearward Amplification	Less than 2
Load Transfer Ratio	Less than 0.6
Low-Speed Offtracking	6.0 m
High-Speed Offtracking	Less than 0.46 m

In a 2008 report written by Wilbur Smith Associates for the Virginia Department of Transportation (VDOT), developed tools to conduct a performance-based analysis of a set of vehicles representative of the Virginia freight vehicle fleet to provide insight into vehicle/roadway compatibility. The performance measures used in the analysis were similar to the Fekpe et al. report:

- Static rollover threshold;
- Rearward amplification;
- Load transfer ratio;
- High-speed transient offtracking;
- High-speed offtracking; and
- Low-speed offtracking.

Performance-based size and weight regulations may offer some appeal in terms of making the trucking industry more productive and efficient, but it would be a fairly dramatic departure in Wisconsin and all other states of the USA. This approach is something that should be watched by the State. Its growth in acceptance in many other countries may signal a need for change.

## 10.7 RESPONDING TO REASONABLE EXCEPTIONS

The previous section talked about the use of performance standards to deal with size and weight issues. Some countries use it more aggressively than others. As noted in Canada, performance measures are used to deal with exceptions to prescribed standards. Wisconsin may want to consider moving a bite in the direction of Canada in dealing with exceptions.

As interviews were done for this project, several people told two stories. The first dealt with a company that could find significant savings by adding another pallet or two to their trucks moving between two Wisconsin plants. The additional load would put the trucks over the legal weight limits. To compensate for this overage, the company was willing to invest in equipment that would place more axles under the load. They were even willing to pay the State an amount to compensate for possible increased wear on pavements and bridges. Under current Wisconsin rules, no solution short of legislation is available to this company.

The second story dealt with milk haulers, who are caught between transportation and agriculture rules. The transportation rules say that the truck cannot exceed a set weight. The agriculture rules say that once the trucker starts to empty a farm tank, the tank must be fully drained. In some cases, the last gallons in the tank boost the load over the legal limits.

Most interviewees agreed that these stories deserved a better ending than current rules and practices allow. Creating that better ending will require creating some procedures to deal with reasonable exceptions to the standards.

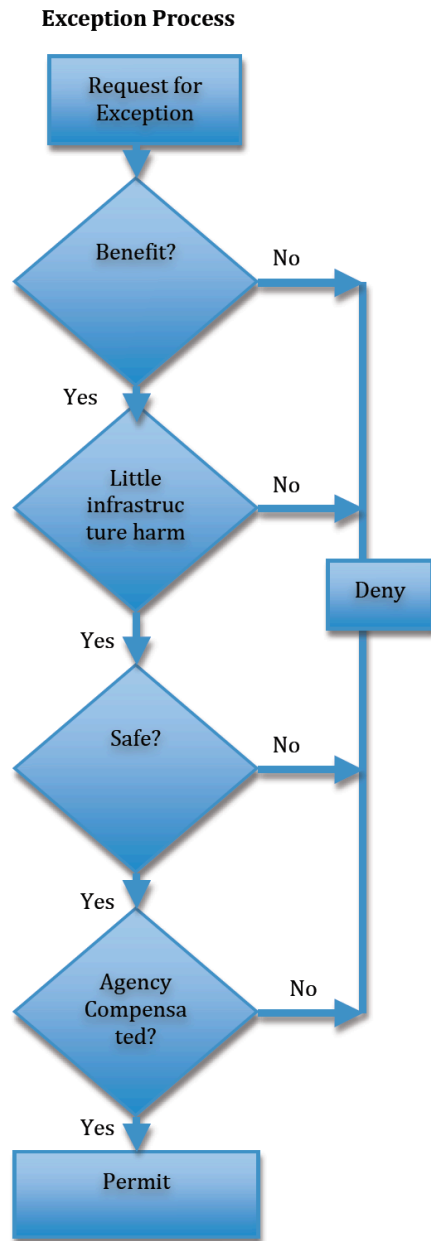

A reasonable process is suggested by the flow chart at the left. When a request for an exception to the standards is received, the first challenge to the requestor is to demonstrate that a benefit will exist if the permit is granted. Typically, that benefit would either be economic – a heavier load would provide a significant savings to the shipper or the carrier – or it could take the form of congestion relief – heavier trucks will be fewer trucks. If this question is answered No, the request should be denied.

If benefit can be demonstrated for the request, the next question deals with how the vehicle will impact the infrastructure. Will sufficient axles be used to minimize pavement damage? Are the bridges that will be used on the route equal to the load? Again, if the answer is No, the request should be denied.

If the vehicle can operate with little harm to infrastructure, the next question should be: Can it operate safely? This question should deal with braking power and acceleration. If the vehicle cannot stop in the same distance as other vehicles or if it cannot accelerate as quickly as other vehicles, the request should be denied.

If it can operate safely, the next question should be: Will the agency be compensated for any damages done and for the cost of analyzing the permit application? The premise here is that the public sector should not pay for a private

benefit. The permit fee should be adjusted to reflect at least the full cost to the agency, and perhaps to reflect a reasonable share of the benefit received by the private interests.

This suggested process does have some problems:

- Those who feel that larger trucks are inherently dangerous will probably not be satisfied with the safety analysis. Opposition will exist.
- The process could prove to be staff-intensive. Particularly at the outset when the specific standards and thresholds are being developed, significant staff time will be needed.
- The process outlined will require some legislative approval. While current permitting authorities may be broad enough to cover allowing some heavier vehicles, even that is open to discussion, the ability to charge fees that are high enough to cover agency costs or to share in the benefits of the permit will require law change.
- The State is not the only jurisdiction that might be impacted by such a procedure. Many local governments might also have their routes used by heavier trucks. To be most effective, those local units should have a stake in the process and buy in to it. They should also have the ability to share in payments intended to cover the public costs of heavier loads.

To deal with some of these issues and to make the process as objective and transparent as possible, WisDOT might consider appointing a committee to oversee it. That committee should have the following representatives:

- The motor carrier industry;
- County government;
- Town government;
- Municipal government;
- Manufacturing industries;
- Agriculture;
- Timber products; and
- Rail.

The role of the committee would be to offer their advice to the department on specific requests received for exceptions. It would review the evidence of benefit received from the applicant and the analysis of agency staff – or their consultants, relating to the impact on infrastructure, safety, and level of compensation. In the long term, the diversity of interests represented on the committee should serve to keep the requests to a minimum and the approvals defensible.

## 10.8 SUMMARY OF RECOMMENDATIONS

The following is a summary of the recommendations contained in the body of this Section.

- The Department should initiate a process with stakeholders in local government and industry to develop measures that reflect the significant aspects of freight transportation in Wisconsin. Several suggestions are made covering issues such as efficiency, safety and maintaining a level playing field. These suggestions should provide a useful starting point for discussion with stakeholders. The final measures agreed upon should have the buy-in of those stakeholders and should form a basis for ongoing discussion on the health of the state freight transportation system.
- The Department should expand its efforts to listen to the shipping and carrying industries. Establishing a freight advisory committee is one good way to begin that process. The report offers alternative approaches to establishing such a committee. The committee is but one approach to better communications. Others include outreach to specific interests on a one-on-one basis or participation in a wide range of industry organizations that have an interest in freight issues. Regardless of the approach taken, some significant amount of staff time will have to be dedicated to the effort. It cannot be done as one additional collateral duty assigned to many people.
- The Department's internal structure also requires better coordination, communication, and alignment. Establishing an internal coordinating committee is a first step in this improvement. A second might be to identify a list of actions that should be taken – policies and procedures reviewed, partnerships undertaken, etc. – that will make considerations of freight issues a normal part of agency operations. Again, if this is to be successful, some staff resources will have to be assigned to it. The example of MoDOT's freight development person is offered as an example.
- The Department should also take steps to help its freight customers better understand the agency. A position with a freight title is one possible measure. A freight web page with directions to other agency resources might also be of help.
- The Department should monitor the activities of other nations, most notably Canada, as they move further in the direction of performance-based standards for truck size and weight rather than purely prescriptive standards. This approach may offer incentives for greater industry innovation and productivity in the long term. In the short term, it would be a major departure.
- The Department should consider developing an administrative procedure to evaluate reasonable requests for exceptions to truck weight rules. Such a procedure would have to evaluate the benefits to the State as well as the safety and infrastructure impacts of exceptions.

These are a set of modest, but important steps that the agency could take to ensure that size and weight laws are understood and serve the State well.

## 10.9 ACTIONS TAKEN

Since this research task was begun, WisDOT has devoted attention to several of the issues addressed in this chapter and progress is being made. Specifically, the following actions have been taken, or are under consideration:

- A standing committee, with membership from four divisions, has been established to coordinate oversize/overweight permits. The goal of the effort is to make the process more consistent and faster, while still protecting the state infrastructure and the traveling public.
- Discussions have begun with Minnesota and, through the Mississippi Valley Freight Coalition, with other states in the region to establish a more coordinated regional approach to issuing oversize/overweight permits. If successful, this should reduce the administrative burden for truckers moving permitted loads through the region.
- An internal management committee, involving four WisDOT divisions, has been established to provide coordination and direction to the total freight effort of the Department.
- Establishing an external freight advisory committee, which would be made up of shippers and carriers across the state, is under consideration.

Each of these steps have been taken or are being contemplated in pursuit of the goal of making the WisDOT more friendly to the freight industry and thus more supportive of economic growth in Wisconsin.

## 10.10 BIBLIOGRAPHY

- Australia National Transport Commission. <http://www.ntc.gov.au>.
- Australia National Transport Commission. *Performance-Based Standards Scheme: The Standards and Vehicle Assessment Rules*. November 2008.
- DiCristoforo, Rob, *Performance-Based Standards: Servicing a Burgeoning Freight Task*. Presentation at Transportation Research Board Annual Meeting, Washington, D.C., January 2007.
- DiCristoforo, Rob, Blanksby, Chris, and Germanchev, Anthony. *Performance-Based Certification of an Innovative Truck-Trailer Configuration for the Safer and More Efficient Distribution of Liquid Fuel in Australia*. ARRB Group Ltd., written for the Transportation Research Board Annual Meeting, Washington, D.C., 2006.
- Edgar, John. *Improving Heavy Vehicle Safety Using Performance Standards*. National Heavy Vehicle Safety Seminar, Melbourne, Australia, 2002.
- Fekpe, Edward, Gopalakrishna, Deepak, and Woodrooffe, John. *Performance-Based Oversize and Overweight Permitting System*. Report for the Transportation Research Board Annual Meeting, Washington, D.C., 2006.
- Maze T.H., et al. *The Potential for Performance-Based Standards as the Basis for Truck Size and Weight Regulation in the United States*. Center for Transportation Research and Education, Iowa State University, 1996.
- Organization for Economic Cooperation and Development. *Performance-Based Standards for the Road Sector*, 2005.
- Regulations of Weights, Lengths, and Widths of Commercial Motor Vehicles: Special Report 267*. Transportation Research Board, 2002.
- Summary Report for Synthesis of Truck Size and Weight Studies and Issues*. United States Department of Transportation Comprehensive Truck Size and Weight Study. Federal Highway Administration, 1995.
- Wilbur Smith Associates. *Task 40: Identification of Minimum Highway Features for Safe Truck Operations*. Report for the Virginia Department of Transportation, June 2008.
- York, James, and Maze, Tom. *Applicability of Performance-Based Standards for U.S. Truck Size and Weight Regulations*. Iowa State University Center for Transportation Research and Education, Semisequicentennial Transportation Conference Proceedings, 1996.



## 10.11 INTERVIEWS

### **WisDOT**

Sandy Beaupre, Director of Planning and Economic Development

Anna Biermeier, Director of Vehicle Services

John Corbin, State Traffic Engineer

Patrick Fernan, Deputy Administrator of Motor Vehicles

Lynne Judd, Administrator of Motor Vehicles

Chuck Lorentz, Chief of Motor Carrier Enforcement

Dave Vieth, Director of Highway Operations

Mark Wolfgram, Administrator of Investment Management

### **Other Departments of Transportation**

Kelly Brooker, Ohio

Keith Bucklew, Indiana

Barbara Ivanov, Washington

John Maddox, Kansas

Ernest Perry, Missouri

### **The Private Sector**

Sid Dye, Verso Paper

Tom Howells, Wisconsin Motor Carriers Association

Jerry Lenz, Spancrete

Daniel Manesis, Manesis Trucking

Betty Nowak, Port of Milwaukee

Lynn Wilson, Plum Creek



# A. Private Sector Outreach Findings

## A.1 OVERVIEW

Extensive stakeholder outreach has been a vital component of the Wisconsin Truck Size and Weight (TSW) Study. When assessing the potential impacts of changes to TSW laws, it is imperative to consider the diverse characteristics of the trucks operating in the state and how alterations could pose a spectrum of impacts. The objective of the outreach effort was to cast a broad net in order to capture a cross-section of the state's trucking industry to adequately address the varied interests of the firms who rely on the state's roadway freight infrastructure. TSW outreach efforts elicited input from private industry representatives to provide input and help decision-makers assess and address issues surrounding the existing TSW laws, including the impacts any changes would have on safety, performance, and roadway management and enforcement. Feedback was sought using the following series of questions:

- Describe your business and the current industry challenges.
- Please describe any barriers your business encounters that prevents efficient freight movements.
- How do Wisconsin TSW laws impact your business today?
- If TSW laws were changed, what impact would they have on your business (change in freight volumes, routes, mode)?
- What solutions would you recommend for consideration to improve freight transportation and goods movement?
- What investments would you be willing to make/or what sources of revenue should be made available to help offset infrastructure improvements (if TSW laws were changed)?
- What transportation trends do you see in Wisconsin and nationally that may impact your business?
- Are there additional stakeholders we should be talking to as part of this study's outreach effort?

## A.2 PARTICIPATION

The private sector outreach effort explored opportunities for changes to TSW laws as well as potential impacts any changes would have on safety, performance, and roadway management and enforcement. Based on previous TSW studies, the most important element for success in the outreach effort is to involve a wide array of stakeholders which are impacted by TSW laws in various ways. Industries included were both diverse in location within the state as well as in business size and operating characteristics.

The study team has divided the private-sector outreach effort into three major components.

1. Major Shippers;
2. Heavy Haulers and Other Carriers; and
3. Oversize/Overweight Special Needs.

While these components are not strictly divided and participants will not be limited to those that fall within these categories, they serve as an organizational principle for the outreach effort.

### Major Shippers

Major shippers play an important role in Wisconsin's economy. They frequently have detailed understanding of the obstacles facing Wisconsin's national and regional competitiveness and ideas to improve and grow the State's economy. Participants were identified based on factors including level of involvement with freight and trucking, location, listing among the Top 100 Companies based on revenue (in the *Corporate Report Wisconsin 2005*), known business practices, and industry. Several shippers reliant on rail transportation as well as trucking were interviewed in order to gauge the impact of current TSW laws on mode share and the impacts of potential changes to TSW laws.

### Heavy Haulers

Carriers, especially in heavy hauling industries, are the most directly affected by truck size and weight laws and have the most intimate knowledge of truck size and weight obstacles and opportunities.

### Oversize and Overweight (OS/OW) Carriers

Oversize and overweight (OS/OW) carriers can provide insight into the permitting process and special needs of Wisconsin's OS/OW carriers. By selecting a sampling of the previous year's applicants for OS/OW from WisDOT's records, a thorough review of the experiences of these stakeholders can be conducted. Outreach targeted those carriers that are regular users of OS/OW permits.

The **industry sectors** specifically targeted for inclusion in the outreach effort included:

- Agriculture - including ethanol and vegetables;
- Dairy;
- Farm Implements;
- Food;
- Garbage/Recycling/Waste;
- Manufacturing;
- Metals;
- Paper;
- Petroleum;
- Retail;
- Scrap;
- Ports;
- Railroads;
- Timber;
- Utilities; and
- Wind towers.

### **A.3 SUMMARY**

Several key themes emerged through the outreach effort. Industries which are reliant on trucking are typically challenged to decrease costs and increase efficiency and timeliness. So interest in TSW changes is hinged upon gains in economic benefits while not creating unfair advantages for competing industries and/or companies. Perceived impacts resulting from TSW changes included: transport cost savings, reduced congestion, reduced vehicle-miles traveled, improved safety, added costs for new equipment and/or upgrades, and a potential for reduced driver demand. It was also speculated that TSW changes would not affect railroads as railroad share is already low, and most operators are too busy to accept additional shipments.

Suggested guidelines for any TSW changes were also raised and are shown in Table A.1.

**Table A.1 Private Sector Outreach Key Findings**

Issue Summary
<ul style="list-style-type: none"><li>• INTERSTATE HARMONIZATION – Any TSW changes (including OS/OW permitting) should be harmonized across state boundaries</li><li>• INTERSTATE HIGHWAY ACCESS – More productive truck configurations should be allowed on the Interstate system, which can accommodate the heavier loads, consider impact of U.S. 41 conversion</li><li>• REVENUE RETENTION – Revenue from permitting should be reinvested in bridge and other freight truck-related improvements along key routes</li><li>• EQUITABLE CHANGES AND EXCEPTIONS – TSW changes should be equitable across industries and existing exceptions should be preserved</li><li>• GREEN POLICY – The State should promote TSW changes as “green” policy (reduced carbon, lower fuel consumption, and less congestion due to lower numbers of trucks)</li><li>• IMPROVED INFORMATION – Information about roads, bridges, and related information should be increased and available on the WisDOT web site</li></ul>

Overall, companies interviewed express satisfaction with current Wisconsin TSW laws, the permitting process, and associated fees. There was general sentiment by companies interviewed that an increase in weight laws would be preferable to carriers, more so than an increase in tractor-trailer size, especially since some tractor trailers are already able to accommodate heavier loads, albeit using the OS/OW permitting process. Fluctuating fuel costs is viewed as a significant challenge to the industry in today’s market. Inconsistencies from state to state regarding truck size and permitting requirements, as well as inconsistencies in restrictions and permitting within Wisconsin regionally, occupy many freight haulers’ time and efforts. Finally, the issue of a reduced field of skilled and qualified drivers was mentioned repeatedly by freight companies. All of these issues, in addition to the fluctuation of freight needs locally, regionally, and nationally, serve to exacerbate the difficulties of the movement of goods in Wisconsin.

The inconsistent understanding and application of rules and restrictions for oversize and overweight loads is a significant issue within the industry. The routine amount of time it takes to process permits is of growing concern and frustration. There is a sense that with some dedicated attention this issue is easily managed and can be overcome through system upgrades and education; and would go a long way to benefit the industry and the economy. A common theme from interviewees is that the Department of Transportation needs to develop consistent policies for the transport of goods throughout the state, and should focus on working with states in the region to ensure the development of policies that if not similar in regulation, are at least similar in practice.

## A.4 MOTOR CARRIER REPRESENTATIVES

Several companies from the agricultural-waste, food, metals, garbage and recycling, construction equipment transport, wind tower transport, forest products, bridge beam transport, and general motor carrier transport industries were all interviewed for this effort. The current industry challenges mentioned consistently throughout the interview process were fluctuating fuel charges, inconsistencies from state to state regarding truck size and permitting requirements, lack of skilled and qualified drivers, and fluctuation of freight needs (i.e., too little or too much work). Following are some major themes that emerged from the interview process.

Federal mandates for equipment and improvements tend to be burdensome according to some companies interviewed. Some carriers would like to see the elimination or lessening of mandates on the use of clean engines, including some EPA quality standards, since the engines then provide reduced fuel mileage and generate operating problems. It appears that the motor carrier industry is blamed for emissions problems more so than the traveling public.

While most carriers indicated that it would be beneficial to increase allowable TSW configurations, they also felt it necessary to lift some of the road restrictions. One solution recommended by the industry is to allow some tolerances for winter weights since drivers are unsure how much snow and ice they may be carrying during winter weather changes.

A current challenge faced by many of carriers is the availability of current information from the Department of Transportation in order to determine adequate routes, such as bridge logs (by route number), a statewide construction map, and a statewide construction update web site. This information should be readily available and accurate to allow for safe and efficient transport of goods. Some companies would like to see more utilization of railroads, identifying them as a highly convenient, highly efficient, and highly profitable means of transporting goods. However, the locations of railroad lines throughout the state are limited with most hauling at or near capacity.

For agricultural waste haulers, current regulations make the very definition of “agricultural waste” difficult. A clear definition is essential because it impacts the ability to understand applicable restrictions and resultant road permits. A fundamental need for additional public education about haul load types and definitions, and subsequent road restrictions was deemed necessary and helpful.

Propane haulers need to abide by safety regulations that allow them to carry at 85 percent capacity, which is typically less than 80,000 pounds. Hence, one petroleum carrier interviewed explained that their trailers are not designed to carry more weight. Even if new trailers were purchased due to an increase in allowable weights, their customers typically have limited space in their storage tanks so they deliver only the amount of petroleum that is needed.

A primary and immediate benefit to a weight laws increase for some carriers is a reduction in time and money spent applying for oversize-overweight (OS/OW)

permits. Some carriers have most of their fleet hauling above 90,000 pounds with OS/OW permits. One company interviewed made their ultimate investment in previous years deliberately purchasing heavier trailers in order to accommodate weights exceeding 80,000 pounds, knowing that they would be utilizing OS/OW permits. A reduction in the use of OS/OW permits would be an immediate benefit to an increase in TSW laws.

Overall, companies are seeing a trend in increasing load sizes, which can typically lead to more expensive transportation costs. If the infrastructure were to allow for larger loads, some freight companies would be willing to make further investments in their hauling equipment.

### **Schneider National**

Schneider National faces challenges concerning safety and highway congestion. With the increase in vehicle miles traveled, congestion is only getting worse since lane miles are not increasing at the same rate. Distracted driving also has an impact on congestion, which in return decreases productivity. There typically has been a nationwide driver shortage and Schneider National is trying to improve driver conditions. Public perception is that trucks are dangerous (approximately 13 people killed everyday in the United States from truck crashes), and it will be difficult to convince public that an increase in productivity is only viable by increasing size and weight. Permitting requirements within any given state can be tedious and costly, but when there's a need to permit due to travel in many states, prices and coordination especially onerous. Schneider has a team of full-time staff to acquire all the need permits for their fleet.

If TSW laws were changed, it would most likely require recapitalization of trailer capacity, which brings forth associated costs. Increasing size and weight would also bring forward mechanical challenges concerning vehicle control and braking, which can be addressed by investing in electronic safety technologies. By increasing TSW, companies are able to haul more freight with the same or fewer vehicles, in return, not increasing congestion. It is clear that the market will have to bear the costs of making the investment to larger trucks, however truck parking may not be an issue if less trucks are operating. Increasing truck size and weight may also have a negative impact on truck security, since there would be an increase in value of cargo.

A University of Minnesota - Morris study revealed that the most productivity growth ever experienced in the trucking industry was over 1982-1997, most likely due to changes in speed limits and length limits (48-foot to 53-foot trailer). Information technology may have helped cut empty miles a bit, which contributes too, but otherwise the results of the study suggest that it did not have very much productivity effect, except possibly in "quality changes" (better shipment tracking, etc.).

Most loads cube out more than weigh out, especially in van division. The representative commented that a 6-axle, 90,000 pound semi may be relatively



easy to retrofit with the additional equipment, which would equate to lower costs and may be more attractive to the company.

Schneider National operates in the lower 48 states and consistency among states' regulations is key. Rather instead of increasing size and weight, the interviewee suggested there be a system put in place to help decrease empty trailer hauls. Most motor carrier companies largely own the trailering capacity that they haul, so there are many companies (i.e., Schneider, Roehl, JB Hunt, etc.) that are passing each other on the highways empty. Shippers should have a shared pool of trailers that can be hauled in order to improve efficiency by reducing the empty miles run by each of the carrier companies. The interviewee does believe there needs to be an increase in size and weight eventually, but there also needs to be an adequate return on investment in order for the private industry to participate. It was suggested that in order to safely increase the size and weight of trucks, truck only lanes need to be considered. Transportation trends seen in Wisconsin and nationally are increased congestion, increased night driving (which can be unsafe), load security, inadequate truck parking available in Wisconsin, and inability to utilize rail. There has also been an increase in exposure to litigation to trucking companies; a trend that is unsustainable and increase in TSW may make this worse.

## **A.5 SPECIALIZED OVERSIZE AND OVERWEIGHT MOTOR CARRIER REPRESENTATIVES**

Oversize and overweight carriers provide critical insight into the permitting process and special needs of Wisconsin OS/OW carriers. Consultation with the WisDOT Division of Motor Vehicles provided a sampling of OS/OW carriers that were contacted for a thorough review of OS/OW experiences. These carriers were chosen for outreach interviews due to their heavy use of OS/OW permits. Highway design restrictions, the permitting and routing process, and the increasing size of OS/OW loads are three of the biggest obstacles OS/OW carriers face when operating in Wisconsin.

### **Geometric Design of Highways**

Current geometric design practices precede many of the concerns for OS/OW haulers. Some carriers are unable to travel certain roads because of the height and weight limits of highway structures. Additionally, the increasing number of roundabouts being built on the state system is a key concern for companies. Roundabouts, with a tight curve radius and a placement of traffic control devices in the center, are typically not designed with a consideration of OS/OW travel. It remains an important dialogue point that roundabouts be designed appropriately for oversize loads, especially now that multitrip permits and oversize loads are allowed to travel on state highways.

The review process length of time by the WisDOT Bridge Section for oversize loads is a point of dissatisfaction for some carriers. These carriers are especially

sensitive to their own set of deadlines and would like to see an expedited review process timeframe. An increasing concern is trying to move loads through the state on routes that avoid the increasing number of 45-ton bridges. One company interviewed suggested removing or relaxing restrictions and/or special permits to move over height loads on the Interstate for nighttime moves from the contract provisions for state highway projects.

### **Consistency in Permitting and Routing**

The challenge of hauling goods throughout the state and region while deciphering varying size and weight regulations and permit application requirements was identified as being difficult and time consuming for companies. Companies hauling heavy loads cited the need for uniform size, weight, and permit application requirements consistent throughout the state and adjacent states.

Haulers propose routes on a daily basis that must be approved by the DOT. The DOT approval process for oversized loads is not fully developed and, as such, requires a fair amount of guesswork by OS/OW haulers. There appears to be some lack of understanding between the DOT and haulers of state regional restrictions, and haulers would like to see restrictions standardized. In addition, it was stated that communication channels and availability with DOT staff need to improve, especially when a submitted route is determined not adequate. Since information provided by DOT staff, regions, and enforcement officers is not always consistent, the suggestion was made by at least one company for a state on-line program, available to carriers, to assist in the determination of proper routes.

OS/OW haulers face the challenge of traveling through Wisconsin, acquiring a number of permits as a result of their travel on different road types. Presently, some municipalities are charging fees that are over and above state permit fees. Some noted that members of their fleet sometimes carry four different permits just to travel in Wisconsin depending on their load. This makes backhauling difficult when picking up additional loads on their return trip. Some companies conducting business in multiple states invest in the purchase of additional trailers for loads that are going to specific states to in order to accommodate the respective restrictions.

Suggestions were made to ease specific restrictions, such as to have a foot taken off current height restrictions and to add a foot to width restrictions for multiple trip permits in order to lessen the risk of trucks hitting bridges and allow wider loads. Or, to collaborate with neighboring states, especially Minnesota and Michigan, to develop standard permits and/or requirements across road types and state lines would ease the permit process, difficulties and expense when traveling regionally.

Overall, the DOT permitting process and designation of allowable routes tended to slow the delivery process for companies. Companies are willing to accept more in permit fees in order to ensure a timely issuance of permits and contribute to necessary upgrades in permitting software. A review, overall, of

state route restrictions and regional permitting would benefit not only the state of Wisconsin in moving freight economically and efficiently but the region as a whole.

### **Wind Tower Moves**

It is expected that somewhere between 75 percent and 95 percent of the energy needed to meet the 10 percent statewide renewable energy target will be generated with wind. The single biggest constraint to increasing wind generation in Wisconsin is the permitting environment, which is far more convoluted in Wisconsin than in neighboring states. Repeated concerns from heavy haulers focused on significantly more restrictions and requirements placed on the transport of wind tower loads than other commodities. Other barriers include limited times for transport, delays in permit processing and weekend travel restrictions.

The wind tower industry, the ports, and the DOT are working together to develop consistent statewide policies. If collaboration is not successful the industry is prepared to submit legislation to implement changes in order to transport wind tower equipment efficiently through the State.

## **A.6 FOREST PRODUCTS (LOGS AND MILLS) REPRESENTATIVES**

The logging industry is facing a number of critical challenges. Increasing fuel costs are having a dramatic impact on the log truckers in Wisconsin and Michigan. Some have hoped to add a few extra cords to each load to help off-set sky rocketing fuel prices but the solutions are not simple. Insurance and hours of service also represent business barriers.

Timber grows in Michigan, Wisconsin and Northern Minnesota without respect for state jurisdictional boundaries, yet the truck size and weight laws vary in each state and impact the flow of commerce and transportation productivity. Michigan has a special trucking configuration which works well in Michigan yet is not legal in Wisconsin. Trucks in Michigan typically have larger engines and are configured to handle larger loads with more axles. These trucks can only travel a few miles across the state line before they have to decouple the second trailer. Wisconsin truckers face a different challenge with lower truck weights and different truck configurations; they are not competitive in Michigan. For companies who own timber across the region, transportation can be a challenge. Many face significant barriers when trying to transport logs across the state lines. Michigan carriers, while they have the option to come to Wisconsin with loads, have to drop the second trailer within 11 miles of the border, run the first load in to the mill and return for the second load. Many of the drop lots that support these operations are not secure; some are no more than vacant lots next to gas stations. Drivers complain that this separation operation is not worth the effort. Michigan truckers who wish to haul Michigan B trains into Wisconsin have to

apply for special licenses and unless there is a steady flow of wood across the border, find this additional cost not worth the effort. With hours of service rules, the drop operation associated with cross border moves must be closely orchestrated so as not to run out of time. Other companies have petitioned for highway segments like Highway 2 from Michigan to Ashland, Wisconsin to be allowed to handle the Michigan configuration. Economic development studies suggest that if the mill in Ashland was closed the regional economic impact could be more than \$20 million.

These issues, combined with the fact that 60 percent of the wood is harvested in a four-month period (December-March), put added strain on an already ailing industry. Trucking is very fragmented with many carriers consisting of five or fewer drivers in Wisconsin. The equipment costs and insurance has significantly increased, so many truckers can not afford to reinvest in the business. Worse yet, few new companies are coming in to take the place of those that fail. The overall profitability of the forest products business in Wisconsin is unpredictable. Several companies are exploring other revenue sources, such as chasing storms (like Gulf Coast hurricanes) to capitalize on revenue opportunities from forest damage instead of staying in the Northern woods during lean times.

Industry associations have tried to tackle some of the more difficult topics such as improved truck productivity through freight pooling concepts to reduce the number of empties miles and increase overall industry productivity. This optimization concept as well as TSW legislation efforts, and improved rail car supply has not successfully helped the industry achieve the necessary productivity needed to result in industry reinvestment.

The Lake State Shippers Association, Michigan Forest Products Council and the Great Lakes Timber Professionals have made several attempts to rescue this flagging transportation sector, yet multi state regulations and policies have proven to be significant barriers to business reinvestment and growth.

New equipment configurations have been suggested which would require a \$3,000-6,000 investment per truck in Wisconsin, which would pay for itself within 4-6 months of retrofitting. Additional barriers include irregular mill hours, some drivers report that mills close early if inventory requirements have been met. Wet loads often weigh more, especially if it is raining; this is an uncontrollable condition for loads moving in an open transportation vehicle yet these loads must also comply with TSW laws.

This group of timber professionals has tried to work with the rail carriers but have had varied success after the sale of Wisconsin Central to Canadian National. Car shortages plagued the industry only to be followed by a reduction in log loading points along the rail corridors. While there have been many efforts to improve rail communication, the business models seem to have changed and service is often reduced to one train per week at many locations, with limited car loading time and an unreliable supply of empty cars for loading. Most rail movement today is coming from Michigan or the West Coast and is more long haul in nature.

In an effort to remain competitive, a push for increased TSW was made only to be compromised by local enforcement efforts. Many of these enforcement efforts were increased after the Minneapolis bridge failure in 2007. Many timber professionals feel that the biggest business barriers are local governments who do not have adequate tools or information with which to make bridge posting decisions. This often results in bridges being posted which add significant out-of-route movements for loggers. One logger cited between Quinnesec, Michigan and Antigo, Wisconsin on County Road A, one such bridge posting requires a 12 mile out-of-route movement, the alternate road is a small two lane highway and adds about half an hour to the overall trip. With four trips per day along this corridor, this extra transit time adds up. At 4.5 miles to the gallon this type of out-of-route movement can also add significant cost to the loaded trip.

Log truckers are willing to invest in productivity improvements as long as their investments are not circumvented by local government bodies. Loggers feel that no one industry can bear the cost of bridge replacement and often point to the fact that many of these roads and bridges have been in place for more than 40 years with minimum maintenance. To burden one industry like the logging trucks after a nearly full lifecycle is seen as unfair by the loggers. This user group feels that government should stay out of the transportation fund, and use transportation dollars only for transportation projects. Many carriers and timber professionals are concerned that if trucking productivity is not addressed the industry may be lost.

## **A.7 MILK HAULER REPRESENTATIVES**

Milk haulers enjoy a reduced truck license fee (\$1,300 for a milk truck versus \$2,500 for a freight truck) but with that reduction are also limited in the payload (75,000 pounds). An average truck burns 12,000 to 13,000 gallons of fuel per month and pays more than \$8,500 in taxes and fees annually; most vehicles average 1,000,000 miles per year. A stainless steel tank trailer costs approximately \$215,000. Trucks could handle up to 80,000 pounds, but are restricted. If a carrier received a ticket for being overweight, some tickets can be up to \$900. The majority of the milk moves on an intrastate basis therefore an increase in TSW would be significant for this industry. Most milk haulers favor the Iowa model for legislation and would like to handle 80,000 pounds.

Paul Dwyer with the Milk Hauler Association estimates that 95 percent of the fleet is quad-axle, 3 percent are tractor trailer (45-foot trailer with 6,500 gallon tank). These tractor trailer combinations often can not get into small back road operations.

There seem to be several types of pay arrangements. Some smaller carriers are being paid by the farmer – farmers usually will not pay fuel surcharge and are more difficult to deal with on a direct basis. Almost no farmers haul their own milk. Many processing centers hire independent owner operators to haul the milk. Most operations have legacy contracts where the farmer pays a daily stop fee. Some farms, due to the operation, have two pick-ups per day which

becomes an added burden to the truckers. Trucks would prefer to do one pick-up per location. Some truck operations only work five days per week, which increased the demand for secondary haulers especially over holidays and weekends. Some dairy haulers have been forced to diversify their trucking operation due to the low pay in the industry. The trailer fleet is typically purchased and held for 10 years before the owner will reinvest. Many haulers are skeptical of the proposed seven-axle configuration due to the potential of increased maintenance costs and the need for additional tires. Several voice concern over the longevity of the new design.

Many milk haulers feel that they are caught between the State DOT, Department of Agriculture and conflicting land use policies. The Department of Agriculture specifies that you can not leave a partial load of milk in a farm cooler. You must pick up the entire tank or dump what will not fit in the tank. This often has drastic implications for the last load. Land use is another issue where many new large dairy operations are putting in such large tanks that it limits the route configuration and pick up options a carrier might have. It was suggested that new farms should put in two smaller tanks to facilitate the pick up regulations.

There is also a 72-hour rule which specifies that each tank trailer must be washed not less than every 72 hours. This can be an issue for truckers serving big dairy operations which have limited loading times. Some operations slot 10 trucks for one appointment time. If a driver misses the time or is last in line and does not get loaded in that rotation, he/she may have to wait 3 to 5 hours for the next load cycle. If this delay occurs late in the cycle, this can be an issue. Haulers have asked for the rule to be relaxed to 96 hours.

Bridges can be an issue in rural townships where the local township governments have jurisdiction over the bridge weight limits. The authority for bridge postings rests with the entity that does the maintenance. Milk haulers feel this is unfair because the feed and the scrap people run overweight permits on the B roads but milk haulers are limited to 75,000 pounds. They also feel that many decisions about bridge weight limits are made without technical training and data driven decision processes.

Milk haulers feel that the transportation fund should be sufficient to cover the bridge costs. They voice concern that transportation money is diverted from transportation projects. They want to increase their maximum allowable GVW to 80,000 pounds.

The U.S. 41 corridor in the Green Bay area is the most heavily traveled highway segment for this business. This group does not favor tolls.

## **A.8 SCRAP REPRESENTATIVES**

The scrap business is in the worst state it has been in the past eight years. Scrap prices are down 80 percent over the last three months. The business environment is challenging as many of the customers have built up an inventory and are not taking more product (foundries and steel mill). The Waupaca

foundry, the largest in the State is down 40 percent. Scrap is a commodity. The sources for scrap are the construction industry and the retail and manufacturing industry. Each of these industries are experiencing economic difficulties. China, which has recently be a large consumer has abruptly stopped their consumption. Many export agreements are being canceled or renegotiated a less than 50 percent of previous levels.

The scrap business is one of the most “green” businesses and has historically been a backbone of Wisconsin manufacturing. Scrap (ferrous) can be recycled indefinitely and provides a low cost source of raw materials for Wisconsin steel and foundry industries.

Scrap is hauled short and long distances that can exceed 200 miles in company owned trucks. Containers are left at job sites to collect scrap, when the containers are picked up it is hard to know the exact contents or the weight of the product. The weight of the scrap is determined by the density of the product. Milwaukee scrap dealers often cross state lines and must abide by Illinois TSW regulations.

Approximately one-half of the scrap moves by rail and one-half by truck. The railroads have been difficult to deal with; scrap shippers have the impression that the scrap is a low priority business for the railroads. Past issues of car availability and service issues were noted.

TSW laws preclude overweight scrap trucks from the Interstate corridors. It was noted that the Interstate is one of the safest places for these trucks to operate. Several examples were mentioned where additional secondary highway miles were incurred, especially in Milwaukee area, due to the fact that these trucks do not move on I-94. Discussion about U.S. 41 and the process to migrate this corridor to Interstate status began. This group strongly advocated that current truck size and weight laws be grandfathered on this corridor as planning continues. The Wisconsin 39-51 corridor was mentioned as an example of this grandfathering process.

In regard to barriers to efficiency, the businesses had several comments. Scrap typically gets dumped in one container at a job site. If construction sites could reliably segment scrap at the job site there maybe an opportunity to by pass collection and sorting sites, however this change in current practice would be capital intensive and would require additional containers at a job site. For some sites this additional space requirement maybe difficult to accommodate. This notion of segregation on site would also potentially slow down the velocity of the scrap. This idea assumes that containers would not be picked up until full, therefore there would be more inventory associated on site until full containers could be generated.

Many of the scrap receivers or foundries are now working during off peak energy cycles. This requires that scrap trucks make appointed times for delivery to match production cycles at the foundries. It was mentioned that it is not uncommon to have these appointments at 3:15, 4:15, and 5:15 a.m. It was also suggested that while rail is an efficient source of transportation, due to lack of

reliability, truck is still the preferred inbound mode. Scrap trucks operate on heavily secondary highways.

The group does not want to lose what they have with TSW changes. They are operating in a very difficult market with uncertain international consequences and with failing inbound feed stocks and manufacturing demand. This industry has figured out how to be commercially viable within the current truck size and weight formulas and does not want to lose any position they have today. If extra axles were required to handle the same loads, it would take away from payload and would increase capital and maintenance costs. A weight restriction which is less than their current configuration would result in more trucks on the road, more fuel burned, more environmental impacts and more labor. There is also concern about a shortage of drivers by 2010.

Suggestions made by this business are to grandfather current laws on U.S. 41, allow trucks on I-94, disregard the impact of rail on the scrap business, extending permit access to 12 months rather than 10 months, and avoid winter weight increases. Consideration of an 11 mile border zone (similar to logging) may be useful. Also the company recommended using transportation budget to fund only transportation projects.

Trends mentioned by the company included noting law enforcement tendencies are varying widely throughout the state and that since off shore product is cheaper than U.S. production (mostly due to U.S. regulations and labor costs), transportation is the key to keep Wisconsin businesses competitive.

## **A.9 AGRICULTURAL-ETHANOL REPRESENTATIVES**

One representative ethanol facility produces 52 million gallons of ethanol per year based on 18 million bushels of inbound corn per year. There are approximately 900 bushels of corn in an 80,000-pound truck. A weight increase would benefit the truckers because the trucks are coming in about three-fourths full. Farmers primarily deliver their own grain to the elevators. Commercial carriers take grain from the elevators to the ethanol plant. In some cases the trucks come out of the ethanol plant with a backhaul of distiller grains (DDG). One-half of the outbound ethanol moves via tankcar on the railroad, with 8,000 gallons per car. The other one-half of the ethanol moves via truck to markets in Rockford, Illinois; Milwaukee, Wisconsin; and Chicago, Illinois. This shipper would prefer a pipeline for outbound shipments but has no plans at the present.

Current business barriers include the rail track infrastructure. Some tracks are currently at a 286,000-pound maximum weight and would like to upgrade to a track equipped to carry 315,000 pounds so that tank cars could be loaded heavier for outbound shipment. There also needs to be joint marketing so that ethanol could move outbound in unit train quantities for additional transportation savings. This plant releases 20 to 30 rail tank cars at a time based on current volumes. Changes in truck size and weight would not change the mode from rail to truck. Truck rates are higher than rail, but do provide important regional reach to local markets. A change in Wisconsin TSW would only impact



Wisconsin customers and this plant has customers in other states which a Wisconsin TSW law change would not impact.

Corn is the number one cost item for ethanol production; energy is the second highest cost. If farmers could load more in local trucks, the farmers would make more money, if delivery costs decrease market penetration would be greater. In today's high cost fuel environment a change in TSW laws may be needed to simply maintain the status quo. In this region, the slow implementation of Illinois road building programs impacts both inbound and outbound shipments. More trucks coupled with a constant state of road construction/congestion lead to poor truck productivity, along with more air pollution by idled traffic stalled by construction crews.

Pipelines could be a solution for the outbound product and would represent a good public works program for the region. There needs to be branch pipeline added to include Minnesota, Wisconsin, and Michigan to the main pipeline network. Improved outbound rail service could also provide some relief.

This business feels that to fund highway infrastructure improvements an increase in road and license tax could be instituted. Tolls do not seem to work when there are alternative roads the trucks can use to avoid them. An ethanol check box should be included on everyone's income tax form and this money should be used like an earmark or a trust fund to finance ethanol infrastructure improvements such as pipelines.

## **A.10 AGRICULTURAL PRODUCTS REPRESENTATIVES**

One agricultural products carrier gave the following description of their representative business practice. Eighty-five percent of agricultural products were grown within 100 miles of the packing plant. A seasonal permit was secured for their fleet of six hopper trucks. Truckload weight from the field is unpredictable based on weather factors such as rain and seasonal moisture. Approximately 9,000 loads of inbound raw product are processed and 4,700-5,000 truckloads move outbound. Trucks typically come into the plant only loaded to 80 percent visible capacity. Approximately 15 percent of the product are brought in from Illinois, these trucks have 50,000 pounds of product on them. Inbound cans are cube sensitive and come in from local sources. Labels typically come in via less than truckload (LTL) shipments. The costs for fuel, fertilizer are sky rocketing and cost containment is a serious issue in this industry.

Today, the Interstate weight limits represent a barrier for this user's transportation network since crops move across state lines and often would benefit from moving on Interstate networks which have faster transit times and shorter routes from the field to the packing facility. Current TSW laws limit the product moved to a location. Typically 102 cases can be moved on a pallet in a truckload, 16 (40 by 48 inches) pallets move per truck, green tip pallets are 50 by 48 inches and typically can only load 11 per truck. Air bags are often needed to secure outbound shipments because of the amount of empty space left in the

trailer. This shipper spends approximately \$600 per truck for airbags, or about \$120,000 per year for load securement products.

If Wisconsin TSW laws were changed, it is not likely to change this business' current rail profile. Today 60 percent of freight moves out via truck and 40 percent by rail. There have been issues with car supply and the perception by this user that the "rail cannot take anymore of their product." While this shipper would like to see more rail shipment, the railroads need to improve rail service and car supply.

Possible solutions for the current trucking situation (high fuel prices) might be to allow overweight loads on the interstate network. Hours of service are an issue for loads coming from Illinois as many loads have to delay at the state line due to the fact that they would be two hours over the hours of service rules if they ran through on a direct delivery. This is problematic with perishable field products. This delay can impact product quality. These movements only occur three to four weeks per year. The carrier felt there should be a seasonal permit variance for this situation.

To fund increase truck size and weight policy changes, this carrier wants "to keep government out of it, this is a local situation." They stressed that tax money collected for transportation should be spent for transportation. "Do not subsidize rail service with highway trust fund, do not spend all the transportation money in Madison." This user stressed that they need to know the total cost of the improvements before it can be decided who should pay. The increases if significant can not be borne by the truckers alone because they need to reinvest in equipment.

## **A.11 PAPER/PRINTING INDUSTRY REPRESENTATIVES**

A major producer of mail order catalogues, annual reports, and magazines has multiple locations in Wisconsin. Paper moves into a warehouse in the Fond du Lac area and then is distributed to printing plant based on order specifications. Inbound customers often schedule their own paper, these sources include overseas, east coast and from local warehouses in Wisconsin. During a busy week, 1,500 truckloads are dispatched to 48 states and Canada. Primary destinations include large population centers like New York, Massachusetts, D.C., Maryland, and Florida. Rail is used to the west coast and some long southern and eastern destinations. If shipments have any stops on the load, then those loads move via highway. They have five print plants and a distribution center in Wisconsin they also have facilities in Martinsburg, West Virginia, Reno, Nevada, Oklahoma City, Oklahoma, Rock, Georgia and Saratoga Springs, New York. Most interplant movements run on their own private fleet; they use some intermodal and not much railcar. Over 100 truck trips per day handle interplant transfers in Wisconsin and could potentially benefit from TSW changes. None of these trucks are permitted for overweight loads today. Due to the large amount of interstate shipments any Wisconsin changes would have a fairly minor impact on this shipper.

Business barriers include anything that would impact or create delays in production. Some of these delays cause print orders to move to other print locations in West Virginia and Oklahoma. Weather is a significant variable which can impact drop shipments. Driver shortages are not evident in this area. Fuel surcharges are passed on to customers by the carriers. There are no equipment shortages at this time.

It is unclear how a change in Wisconsin TSW would impact this shipper. They ship heavy products and would prefer to load 48-foot trailers first. Fifty-three-foot trailers are not an advantage and can contribute to load shifts and damage if not properly loaded. If they could load two additional pallets per truck this would weight 84,000 pounds. No skid can exceed 18,000 pounds and they can stack two skids high, if they are not tall skids.

Potential concerns associated with increased truck size and weight include that heavy trucks consume more fuel, and that heavy trucks would likely have a higher accident rate due to increased stopping distances, requiring increased insurance costs. This might impact equipment specifications and customer order quantities. Shipper insurance would go up because there would be more product on each load. On the other hand if transportation costs could go down and shippers could get two extra skids per truck, (4,000 pounds per truck), this could result in printing more catalogues for each order. For example, instead of ordering 100,000 catalogues in a truckload quantity they may order 125,000 catalogues.

No specific solutions were identified for funding increase truck size and weight options. It seemed that increasing truck license fees was the easiest approach. Drawbacks to designating specific corridors for overweight permits, included the uncertainty of customer shipments and having sufficient flexibility to handle “unplanned” loads.

## **A.12 MINING PRODUCTS REPRESENTATIVES**

“Frac sand” from Wisconsin is used in the oil and gas drilling process to help extract more oil and gas from each well. The special properties of this raw material from Wisconsin are so valuable in the mining process that it is widely distributed in states as far away as Pennsylvania and Oklahoma because of the small, fine nature of the sand grains. A light pneumatic truck can carry 27 tons of sand and stay within an 80,000-pound gross weight limit. If heavier truck weights were allowed up to 58,000 pounds per load (gross vehicle weight of 87,000 pounds) this company would build trailers with different specifications. It is not clear if an extra axle could be added to the current trailer configuration.

The company runs five dump trucks to a local foundry which is configured with a quad axle which supports a 22 ton payload and a 73,000-pound gross truck weight. They are not using a TSW exemption today like the scrap haulers. Bulk and bagged sand also moves to local foundries and as far as Pennsylvania and Iowa in semi’s which can load to 90,000 pounds, but these vehicles have often

had stability issues during the unloading process and tend to tip over if not carefully handled.

Running heavier trucks would reduce labor costs and the number of trucks needed for the operation and would be supported by this company.

Small bridges on local roads in Waupaca and on WIS 49 could represent a problem. Rerouting around local bridges can add time and as much as 20 extra miles between the truck depot and Waupaca.

Half of the outbound product moves via rail (five rail cars per day) and one-half moves via truck. Rail service has been unreliable and when cars do not show up or are delayed en route it takes 4 trucks to equal one rail car shipment. Hours of Service laws were cited as a business barrier for times when trucks need to be dispatched for the “rail recovery” shipments. Increased TSW laws would not reduce the current rail volumes. Most who order rail quantities want it delivered to rail served facilities. Rail detention and other activity based charges are increasing the cost of rail transportation. Toll roads in other states such as Ohio are very expensive for heavy trucks. Most sand truckers try to avoid tolls and use U.S.-41 through the Chicago area instead of I-294. Using tolls to pay for increased truck size and weight was not favored. Truck license fees increased this year and additional increases were not favored, yet the recognition that doing more (volume) with less (labor) was important as fuel costs have increased.

Some sand comes in from Canada. These trucks have to stop at the border and relay back for the second load. This is not an efficient use of time. One potential solution include permits, which would be acceptable if all states would coordinate their requirements.

## **A.13 CONSUMER PRODUCTS MANUFACTURING REPRESENTATIVE**

The business interviewed moves heavy liquid household products, and trucks are only three-fourths full before they reach weight limitations. Average truck weight is 45,000 to 47,000 pounds. Industry challenges include fuel cost increases, customers who are managing declining inventories, and highway congestion in urban areas primarily along I-94 between Milwaukee and Chicago. Business barriers include different TSW in different states, congestion and the lack of rail facilities and shipping options.

TSW directly impact their 15,000 inbound trucks per year, outbound shipments move 50 percent via rail intermodal to distribution centers in California, Texas, Georgia, and Pennsylvania. The Midwest is served by a distribution center in Kenosha, Wisconsin. About 50 percent moves by truck to other regional distribution facilities. The transfer shipments from Wisconsin plant to distribution center in Kenosha, Wisconsin could potentially benefit from new TSW rules if bridge weight limits did not impact the route on intrastate movements. These short haul movements between the plant and Kenosha, if

TSW could be increased, could result in 25 percent fewer trucks in southeast Wisconsin, an area already heavily congested.

This company stated that a change in Wisconsin TSW would not result in freight diversion to/from railroad. Inbound bulk materials would still arrive in rail carload service. Outbound trucks would see little impact because of the interstate nature of the freight distribution activities. Outbound shipments moving via truck could convert to intermodal rail service in some lanes if Wisconsin had better intermodal rail access. Better intermodal access could result in “hundreds of thousands of dollars in savings, which would off set fuel increases.”

This company feels that if TSW were increased the truck rates may incrementally increase (due to greater fuel consumption) but that the overall transportation costs should decrease as more freight would move via fewer trucks.

Overall industry trends for this customer include changes in carrier behaviors as a result of high fuel costs. These increase costs are impacting the bid/award system as carriers become more selective in the lanes they are willing to handle. Due to increased costs, their customers are reducing inventory which is pressing them to deliver product to receivers on a more frequent bases with lower average order weight. Many carriers are looking at programs like Smartway and are looking at driver behaviors, maintenance, tire pressure, equipment innovations and fuel saving technologies.

## A.14 BREWERY REPRESENTATIVES

Today this shipper moves 22 pallets per shipment and averages 46,000 pounds per truck using a typical configuration with 17 feet of unused space in the trailer. Allowing *2 additional pallets* (4,000 pounds more than current average) would have substantial impact. A rough estimate of \$2 million to \$5 million annually for this brewery alone (not including benefits from regional distributors). A recent study which analyzed the impact of adding a single pallet (prior to the recent merger) resulted in the following transportation benefits: \$237,000 in savings (post merger estimated \$500,000), \$250,000 savings in fuel, less carbon emission due to lower fuel, 11,000 fewer shipments (post merger potential of another 10,000 fewer), and a decrease of 3.4 million vehicle-miles traveled.

This company also identified several benefits of TSW changes.

- Distributors are located based on projected case volume sales, and would benefit significantly if they could increase TSW, especially intrastate. This would result in fewer but larger local deliveries. This would result in fewer trucks, less labor, less pollution.
- The brewery is concerned about the equipment issues and potential cost increases for maintenance or larger engines on different configurations.

- The brewery would not see driver pay increasing because they are doing the same work (same lanes, route miles etc). Therefore, truck rates could come down.
- The brewery uses common carriers and feels that the carriers who find out how to haul more weight will be rewarded with the business, rather than rate increases unless there is economic justification.

In regard to funding, the business saw the need to do the business case analysis to determine where cost and benefits reside. This shipper does not compensate carriers for tolls and tells carriers to put the tolls in the rates. They would assume increased costs associated with TSW would be treated like tolls, and would be included in the rate. The shipper feels permitting is a better option and would not hamper productivity by toll collection or other congestion creating methodology. Lastly, the company does not see a need to change current fuel taxes.

Current trends identified by this company included fuel increases costs (reduces consumer demand), efficient equipment utilization (very important given that they are a weight (not cube) shipper. Trying to get the most out of transportation budget), investigation into specialized equipment, and the need to build better network efficiency.

The brewery made four primary suggestions: TSW laws should be more uniform across all states; network efficiencies should be increased; 20,000 pounds per axle is necessary to handle brewery product; and uniform standardization across U.S. would be beneficial (including County, State, and Federal Roads).

This company determined that mode conversion is not an issue as only one distributor is served by rail the rest is trucked based on delivery windows and length of haul. The brewery used 5 percent or less rail to 20 distributors nationwide.

# B. Public Agency Outreach Findings

## B.1 SUMMARY

The goal of the public agency outreach effort of the Wisconsin Truck Size and Weight (TSW) Study was to capture the inputs of public agencies and organizations directly involved in or affected by TSW laws, standards, and issues. Several workshops were scheduled and included representatives from a variety of technical functional areas including engineering, maintenance, and enforcement. Public agency interests were advanced by representatives from State, county, and local governments.

The views represented in this Section are the opinions and observations of study participants and do not necessarily reflect the any conclusions by WisDOT.

### **Outreach Components**

Public agency outreach was conducted through four primary mechanism, each discussed below.

#### *Informal Interviews*

Throughout the course of the study, researchers worked closely with many public agency stakeholders. They were given an opportunity to provide feedback on the direction of the study and provide comments on the current TSW environment and the potential impacts of any changes.

#### *Public Agency Outreach Workshops*

Two Public Agency Outreach Workshops, including county and local government representatives were held, focusing on raising awareness of the project and proposals and identifying needs, issues, and policy positions regarding TSW laws.

#### *Safety Issues Workshop*

A Safety Issues Workshop was held. The focus was identifying the safety concerns associated with trucks in Wisconsin, learning from safety stakeholders how any changes to TSW laws could impact the safety of Wisconsin's roadways, and identifying potential recommendations for improvements to truck safety. Several public agency participants shared their viewpoints.

### *TSW Stakeholders Workshop*

The outreach component of the study culminated with a TSW Stakeholders Workshop in early December 2008, which included participants from both public agency and private stakeholder organizations. Comments related to public agency needs and opportunities are captured below.

### **Outreach Findings**

Some of the key themes emerging from the public agency outreach effort are shown in Table B.1.

**Table B.1 Public Agency Outreach Key Findings**

<b>Category</b>	<b>Issue Summary</b>
General Approach	<ul style="list-style-type: none"><li>• Changes to TSW Laws should:<ul style="list-style-type: none"><li>– Be fair, equitable, and understandable</li><li>– Examine what current and future infrastructure allows</li><li>– Consider impacts on other freight modes</li></ul></li></ul>
Economic Development	<ul style="list-style-type: none"><li>• Keeping Wisconsin’s economy healthy and competitive is critical;</li><li>• Emphasize link between state infrastructure spending and economic health of industry</li><li>• Current TSW laws limit port traffic due to complexity</li></ul>
Enforcement	<ul style="list-style-type: none"><li>• Current enforcement tools (level of enforcement and low fines) foster an “incentive for noncompliance”</li><li>• Enforcement power should be increased</li></ul>
Safety	<ul style="list-style-type: none"><li>• Analyze effect of large trucks on highway safety</li><li>• Evaluate safety risk for bridges</li><li>• Consider requirements for truck safety countermeasures</li></ul>
Infrastructure	<ul style="list-style-type: none"><li>• Designate heavy truck corridors (to limit county/local road use)</li><li>• Evaluate bridges, geometric design of intersections</li></ul>
Federal-State	<ul style="list-style-type: none"><li>• Federal leadership is needed for significant TSW changes</li><li>• Consider impact of U.S. 41’s conversion to an Interstate highway</li></ul>
Revenue	<ul style="list-style-type: none"><li>• Ensure direct linkage between commercial vehicle revenues and covering the costs of heavy trucks’ impact on the transportation system</li><li>• Transportation revenue and funds should be invested into transportation alone, with a focus on preservation/rehabilitation of existing infrastructure</li></ul>

These and several other points of interest are captured in greater detail in Section B.2.

## **B.2 IMPACT OF TRUCK SIZE AND WEIGHT LAWS TODAY**

The existing laws and exceptions provide for some loopholes and misunderstanding. Some stakeholders felt that better training on the laws is necessary due to the many variations in restrictions depending on types of loads



and where the load is traveling. Some questions arose with regard to unfair law practices when one industry is allowed to operate a larger/heavier vehicle than another. The good of the economy and the need to keep Wisconsin competitive were stressed as critical by stakeholders.

### **Costs/Funding**

Stakeholders felt that the link between state infrastructure spending and the economic health of Wisconsin's industries should be made more apparent. There are an increasing number of vehicles but few new lane-miles. There is a potential that a boost in infrastructure funding would increase number of jobs in construction. Stakeholders felt that restrictions on wind tower movements have made the industry look to other states, which results in loss of economic development.

### **Local Enforcement and Compliance**

There is much concern among counties and towns about the impact of overweight trucks on local/county roads due to lack of compliance with current TSW laws. Local roads are very sensitive to overloaded trucks; one truck can do a lot of damage. Routing becomes key when roads cannot handle weight. Stakeholders felt there needs to be a focus on preservation of roads rather than new construction of roads. The current Class B law (§§348.16) does not require trucks to receive local permission for traveling on the local roads unless the road is posted at a lesser weight for a specific reason.

Fines are minimal and enforcement resources lacking, leading to an "incentive for noncompliance." Counties try to have sheriff departments enforce TSW laws, however, there are limited staff resources and laws are not very favorable for enforcement. There are many restrictions on how long an officer can delay a trucker and how far off the route the officer can take the trucker to reach a weigh scale. The implementation of a law similar to Minnesota's Relevant Evidence Law would allow state enforcement officials to examine weigh bills and issue civil penalties for overweight loads which could increase agency revenues.

Stakeholders highlighted the need more inspection and weight enforcement officers due to the increasing number of trucks on the roads. They stressed that if the allowable weights go up, the tolerance for noncompliance needs to be even less than it is currently and there needs to be more officers enforcing the laws. Technology for improving freight transportation and increasing enforcement exists, but the public agencies and private industries need to implement it (i.e., photo imaging enforcement, on-board scales, etc.). Some stakeholders felt there should be a Federal mandate to require wireless scale devices installed on all trucks when built after a certain date.

### **Geometrics and Structures**

Several local government participants felt changes in geometric design, especially for roundabouts, need to be addressed when considering longer

trucks. Roundabouts are becoming more prominent in Wisconsin and it is difficult for larger loads to move through them. Intersection size is continually increasing due to increase in volumes. Designers are required to pull radii back, increase the right-of-way used, and time traffic signals to accommodate larger intersections and larger trucks traveling through the intersections. Congestion also plays a part on highways and at intersections when large trucks make certain turning maneuvers.

Stakeholders felt the state and local agencies need to agree on a consistent method to analyze the safety risk of larger trucks on bridges. The cost of structural fatigue on bridges due to larger trucks should be determined and not just the monetary costs for replacing/repairing bridges.

### **Safety**

Several issues of concern related to large truck safety were raised during discussions with stakeholders. These include:

- The need for early and continuing education of CDL drivers;
- The need for consistency on clearance intervals on signalized roadways with a high percentage of truck travel; and
- An increasing gap in size between passenger vehicles and large trucks when operating on the same system.

### **Other Modes of Transportation**

Current TSW laws limit port traffic and are complicated and difficult to interpret. Nevertheless, there appears to be a national effort to move more goods through ports, which increases truck traffic due to lack of access in waterway usage. The impact of the rail industry changes has resulted in a loss of service making it difficult for industries to utilize rail.

## **B.3 POTENTIAL CHANGES TO TSW LAWS**

Stakeholders generally agreed that any changes to TSW laws should: be fair, equitable, and understandable; examine what the current and future infrastructure allows; and consider impacts on other modes. Current funding gaps for transportation projects makes this a difficult time for change, which in turn, may increase maintenance burdens.

In order to minimize exceptions and loopholes in laws, stakeholders urged the Federal government to consider a national standard for truck size and weight, so that states have the same laws and can operate at a regional level without discrepancies. There may also be potential for a regional standard that could influence Federal standards.

At the local level, public agencies reported difficulties in improving the local roads. A process should be in place, which requires heavier loads to only travel on the routes that have been improved to handle the size and weight rather than

deteriorating the roads that cannot handle the larger loads. Some felt it may be helpful to designate certain routes or corridors for heavy truck traffic as well as review current road and bridge postings to determine if rational.

## **B.4 POTENTIAL IMPACTS OF CHANGE**

Change could boost efficiency in several industries, but this needs to be balanced with the costs of maintaining infrastructure. Stakeholders felt that potential benefit to taxpayers, infrastructure costs, equipment costs and operating costs all need to be considered if change occurs. If the laws change, there may be a need to grandfather in equipment with existing loading due to the capital costs of purchasing equipment. Changes would require more enforcement training and resources to strictly implement the laws and keep the roads safe from illegally oversize trucks.

The conversion from U.S.-41 to an Interstate highway may affect freight issues because there are different restrictions for state highways versus Interstate highways. Increase in size and weight will impact the design of state facilities, such as roundabouts, work zone setups, intersections, and signalized intersection timing; larger trucks would require longer stopping distances.

In some instances, trucks use county highways more because of the better quality roads than some secondary state-owned highways. In that case, the roads deteriorate faster than other roads, so counties place restrictions on those highways. Due to this, the counties receive negative feedback from the trucking industry and locals for highway restrictions, but it is necessary to keep restrictions in place because the roads will deteriorate faster than they can be replaced. If heavier vehicles are allowed on some routes, it is important to keep them off local roads.

Stakeholders felt of the potential impacts on roadway safety might include:

- If TSW were increased, then additional stopping distance is needed and braking and handling of larger trucks may become a problem;
- Winter weather travel may have an impact on the operating and handling of larger trucks if sizes and weights are increased; and
- If TSW laws change, WisDOT must assess the impact of CDL licensing and current CDL licensed drivers. There may be a need to re-examine drivers for operation of larger trucks.

## **B.5 OTHER SOLUTIONS**

There are a number of other solutions that were an outcome of the public agency outreach such as use of certain technologies, use of other modes, and changes in the ways of doing business. Examples include the deployment of new technologies and logistics to increase fuel mileage, decrease tire wear and decrease impact on roads; identify specific freight corridors to handle heavier

trucks; promote regional consistency within the state and between adjacent states; require travel at certain periods of the day; increase truck weight allowances at night or off-peak periods; and allow higher weight permits if U.S. DOT score is at a certain range to ensure safe drivers are operating larger loads.

Stakeholders felt there is always a need for more communication and education between locals, state, and industry in order to develop an improved system for moving commerce.

## **Sources of Revenue**

Public agency stakeholders expressed a strong desire for revenues from commercial vehicle operations to cover the costs of heavy trucks' impact on the transportation system. They felt an increase in revenue may be able to help pay for damage/improvements to the highway system and cited the ultimate goal as increasing the revenues enough to cover these costs. They felt transportation funds should be invested in to transportation infrastructure and focus on preservation/rehabilitation of the existing system.

One method for increasing revenues might be to increase registration and permitting fees. Public agency stakeholders noted that although Wisconsin has low fine and permit fees, the registration and licensing fees are higher. Private industry may be willing to pay more to move if there's an equal or increased payout. WisDOT should consider what other states require for payment regarding training, fuel tax, regulation, licensing and be similar.

Another revenue generating mechanism could be an increase in oversize/overweight permit fees. Stakeholders felt that overweight permit costs are very minimal to the impacts of the trucks on the roads and the cost to move signs and traffic signals for very large oversized loads. The risk and penalty for being caught with an overweight load by enforcement is less than if the driver made multiple underweight trips. An increase in the cost of fines for violators would naturally increase self-compliance within the industry. Currently the revenues from fines just cover the costs of doing business.

Stakeholders identifies other means of drawing in revenue, including: implementing user based fees, truck usage fees or other technologies to collect revenue such as toll roads; implementing private partner funding; and defining fixed routes/corridors for industries and having those specific facilities funded by the permit fees from those industries.

## **Safety**

Public agency stakeholders proposed several potential truck safety countermeasures that could potentially be implemented in accompaniment with changes to TSW laws. These include:

- Mandating the exact placement of front bumper mirrors on tractors to see blind spots;
- Allowing enforcement to obtain information from the electronic control module (ECM) when large truck crashes occur, for the sake of data collection;
- Using highway technologies to warn drivers or law enforcement, such as bridge sensors, rather than relying on drivers to install equipment;
- Increasing enforcement on hours of service violators; and
- Installing more parking for large trucks.



# C. Performance-Based Evaluation of Selected Vehicles

## C.1 INTRODUCTION

The objective of this Appendix is to provide an engineering assessment of the performance of the candidate vehicles that have emerged from Wisconsin Truck Size and Weight Study. The analysis is based on well established vehicle performance measures that define the spatial and dynamic characteristics of the vehicles. Each performance measure has a pass fail criteria that can be used to determine the acceptability of the vehicle. The procedure allows for adjustments to basic vehicle layout such as axle locations and coupling options to achieve improved or acceptable performance.

The performance measures are evaluated by computer simulation. UMTRI's Yaw/□Roll simulation package was used to evaluate the vehicles. The simulation package is based on Newtonian physics and has been validated by field tests. The Yaw/□Roll simulation focuses on vehicle dynamics excluding brakes and acceleration.

## C.2 CANDIDATE VEHICLES

Six vehicles are evaluated in this truck size and weight study (see Figures C.3-C.8). Each of these vehicles was evaluated at the proposed maximum GVW. The analysis of the eight-axle 108,000-pound double (Figure C.7) was performed assuming B double configurations. The vehicles simulated are as follows:

1. Six-axle tractor semitrailer 90,000 pounds;
2. Six-axle tractor semitrailer 98,000 pounds;
3. Seven-axle tractor semitrailer 97,000 pounds;
4. Eight-axle double trailer B-train 108,000 pounds;
5. Seven-axle single unit truck 80,000 pounds; and
6. Six-axle truck and trailer 98,000 pounds.

**Note:** The B-train configuration utilizes a fifth wheel on the rear of the lead trailer. The rear trailer therefore couples directly to the lead trailer as shown in Figure C.1. This connection eliminates one point of articulation from the more common A-trains (Figure C.2) and couples the two trailers in roll producing a more dynamically improvements in coupling greatly enhances dynamic stability of the vehicle.

**Figure C.1 Illustration of B-Train Trailer-to-Trailer Coupling**

**B-Train**

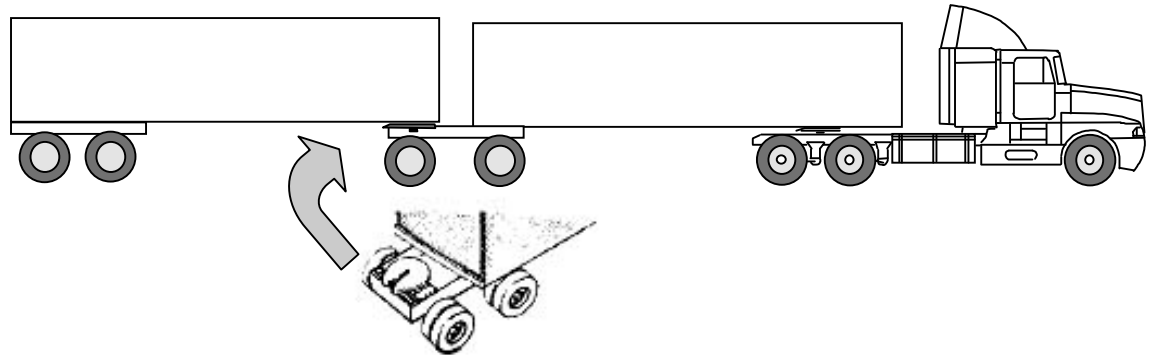

**Figure C.2 Illustration of A-Train Trailer-to-Trailer Coupling**

**A-Train**

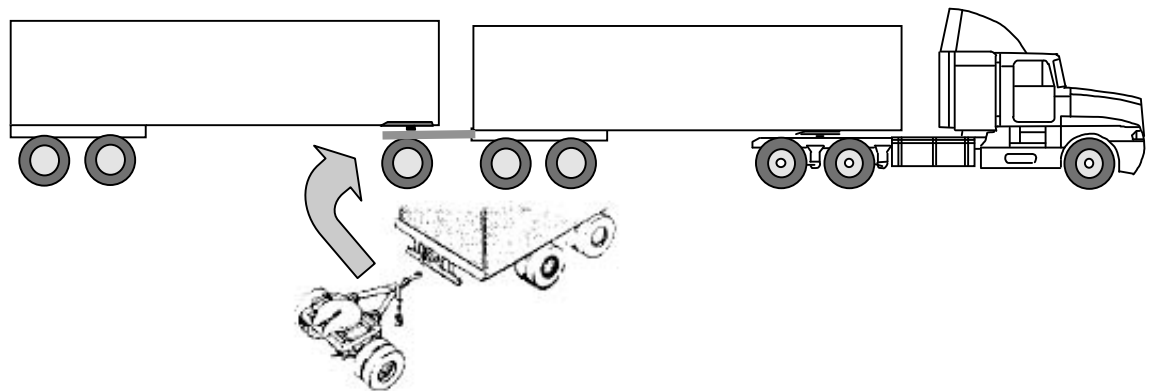

The straight trucks illustrated in Figure C.7 and C.8 are identical vehicles with the exception of the number and location of self-steering axles which are required to allow the vehicle to maneuver. The symbols “SS” above the axles indicate that the axle is self-steering axle. The layout of the castor steer axles have a significant effect on vehicle behavior. The self-steering axles were configurations for most favorable response and for least favorable response. Special consideration in the analysis was given to the steering performance of this vehicle.



**Figure C.3 Six-Axle Tractor Semitrailer with GVW 90,000 Pounds**

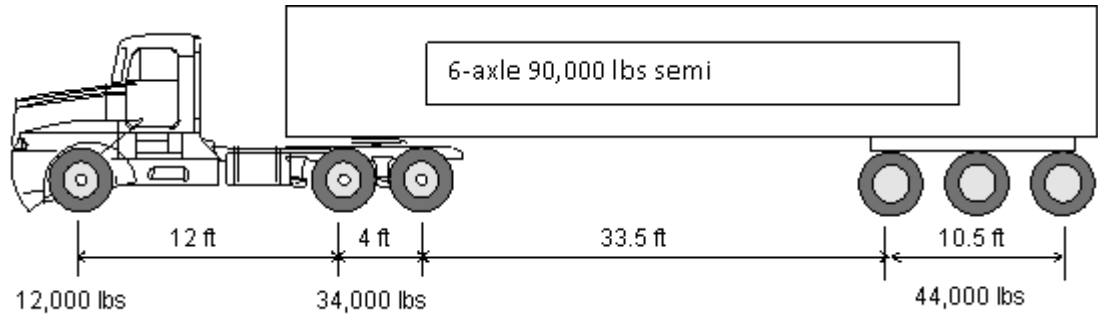

**Figure C.4 Six-Axle Tractor Semitrailer with GVW 98,000 Pounds**

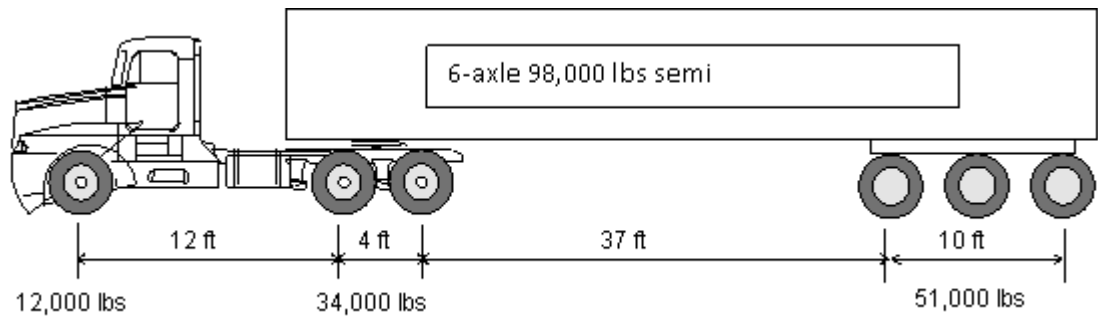

**Figure C.5 Seven-Axle Tractor-Trailer Utilizing a Four-Axle Tractor with GVW 97,000 Pounds**

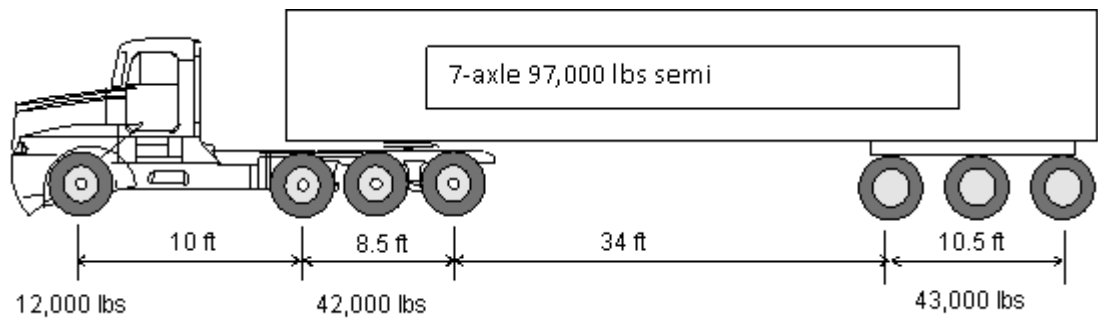

**Figure C.6 Eight-Axle B-Train with GVW 108,000 Pounds**

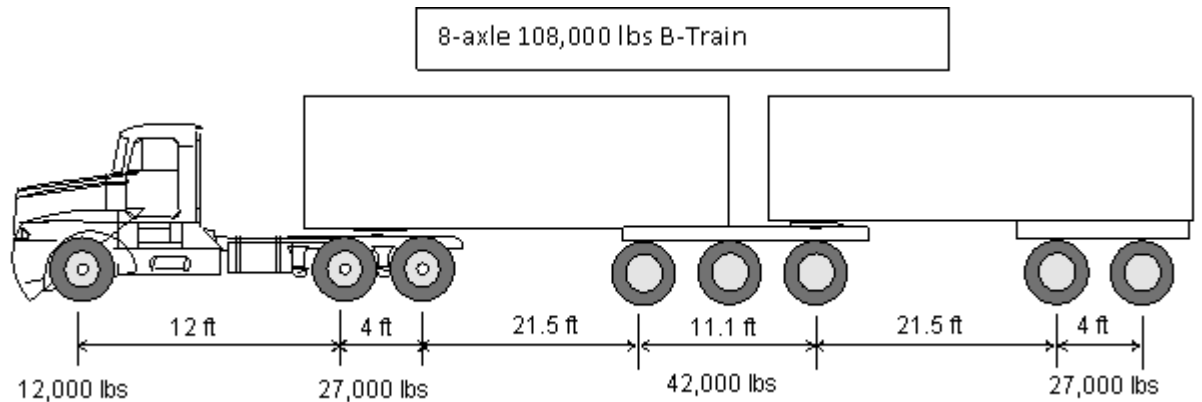

**Figure C.7 Seven-Axle Straight Truck with GVW 80,000 Pounds with Self-Steering Axles at Locations 2, 3, and 4**

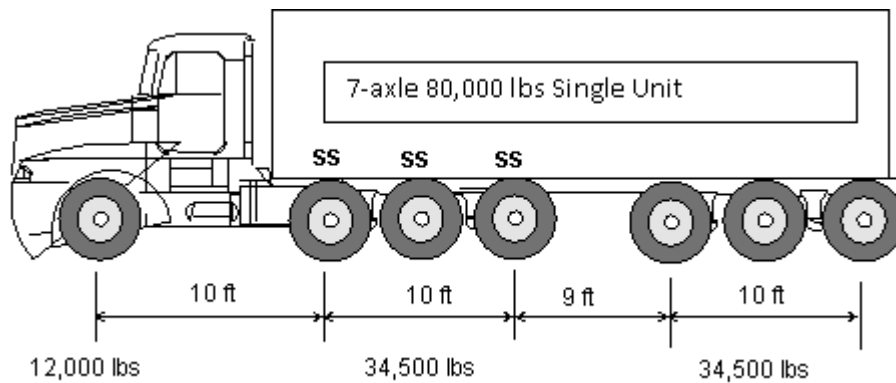

**Figure C.8 Seven-Axle Straight Truck with GVW 80,000 Pounds with Self-Steering Axles at Locations 2, 3, 4, and 7**

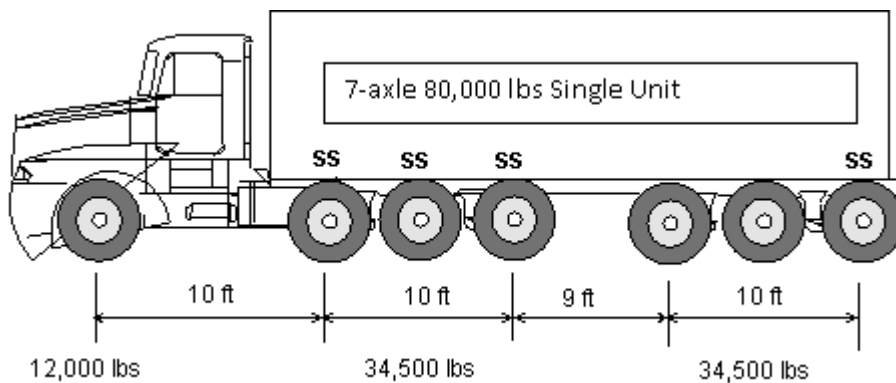

**Figure C.9 Six-Axle Straight Truck and Trailer with GVW 98,000 Pounds**

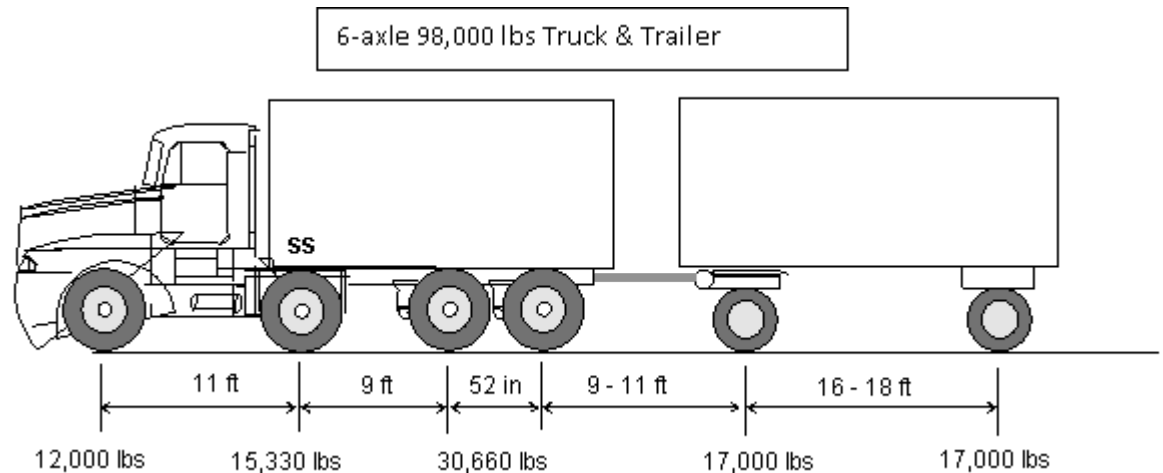

### Assumptions

1. All power units have 96-inch-wide drive axles. All trailers have 102-inch-wide axles with air-suspensions.
2. Typical load distribution of 70 percent of the payload mass located in the bottom 50 percent of the load space.
3. Load space is 2.8m high above the load bed.
4. All trailers and truck load bed heights are 1.27m above the ground plane.
5. For the seven-axle straight truck condition 1) axles 2, 3, and 4 are self-steering axles. Condition 2) axles 2, 3, 4, and 7 as self-steering axles.
6. Axle 2 of the six-axle straight truck and pup configuration (Figure C.9) is a self-steering axle. The connection to the pup is an A-dolly and the hitch point is assumed to be 24 inches aft of axle 4.

### Performance Measures

Eight performance measures were evaluated for each of the vehicles and are defined as follows:

- Static Rollover Threshold (SRT);
- Rearward Amplification (RA);
- Load Transfer Ratio (LTR);
- Low-Speed Friction Utilization (LSFU);
- High-Speed Friction Utilization (HSFU);
- Low-Speed Offtracking (LSO);
- High-Speed Offtracking (HSO); and
- High-Speed Transient Offtracking (HSTO).

A description of the performance measure to be evaluated follows:

*Steady-State Roll Stability:*

Steady-state roll stability is an expression of the magnitude of lateral acceleration required to produce vehicle rollover. It is given as a proportion of gravitational acceleration (g). Total rollover occurs when the wheels on one side of the vehicle lift off the road surface, as illustrated in Figure C.5.

**Figure C.10 Illustration of Rollover Initiation**

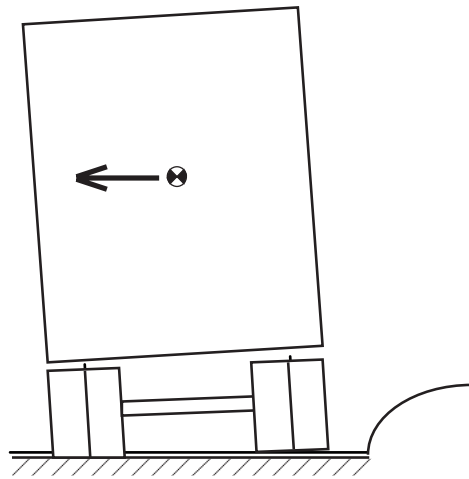

Rollover occurs when the lateral acceleration equals or exceeds the vehicle's rollover limit (which may be assisted by roadway crossfall or camber). Lateral acceleration on a curve is highly sensitive to speed, and the speed required to produce rollover reduces as the curve radius reduces.

Roll stability is influenced by the center of gravity (COG) height, the effective track width provided by the axles and tires, and the suspension roll characteristics. The COG height is affected by the chassis height, load space height, load space length, and average freight density. The significance of roll stability depends on the commodity, body type, and operation involved.

This performance measure is evaluated in terms of the steady-state lateral acceleration at which all wheels on the inside of the turn have lifted off the road surface. This is accomplished by increasing the steer angle of a vehicle unit until all axles on one side of a given vehicle unit lift off.

*Rearward Amplification*

When articulated vehicles undergo rapid steering, the steering effect at the trailer is magnified, and this results in increased side force, or lateral acceleration, acting on the rear trailer (see Figure C.11). This in turn, increases the likelihood of the trailer rolling over under some circumstances. As an example, a truck faced with the need to change lanes quickly on a freeway to avoid an accident can do so at less risk if it has favorable rearward amplification characteristics.

Similarly, steering from side to side produces more lateral movement at the rear unit than at the hauling unit. Rearward amplification (RA) is defined as the ratio of the lateral acceleration at the center-of-gravity (COG) of the rearmost unit to that at the hauling unit in a dynamic maneuver of a particular frequency. Rearward amplification expresses the tendency of the vehicle combination to develop higher lateral accelerations in the rear unit when undergoing avoidance maneuvers; it is therefore an important consideration, additional to roll stability of the rear unit, in evaluating total dynamic stability. Rearward amplification also relates to the amount of additional road space used by the vehicle combination in an avoidance maneuver.

The number of articulation points and the overall length generally influences rearward amplification. Other important factors are the cornering stiffnesses of the trailer tires and their relationship with the axle weights of the trailer. While rearward amplification is an important performance attribute for multi-articulated vehicles, it is generally of lesser significance for tractor-trailers.

**Figure C.11 Rearward Amplification of Lateral Acceleration**

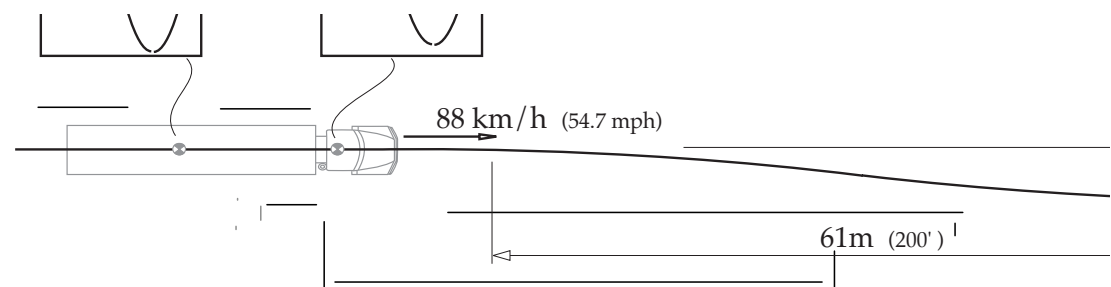

### *Load Transfer Ratio*

Load Transfer Ratio (LTR) is defined as the proportion of load on one side of a vehicle unit transferred to the other side of the vehicle in a transient maneuver. Where vehicle units are roll-coupled - as in tractor-trailers and B- trains - the load transfer ratio is computed for all axles on the vehicle. When the load transfer ratio reaches a value of 1, rollover is about to occur. The LTR is a vital measure of rollover stability and is particularly relevant to high-speed operations in dense traffic.

### *Friction Utilization*

Friction Utilization is the nontractive friction required between the tires and the road surface at any axle of a vehicle combination. It is a measure of the lateral shear force between the tires and the road that results from the vehicle negotiating a curve in the road or carrying out a transient maneuver. The friction utilization of the steer axle tires is considered to be the most critical parameter under slow speed conditions. If saturation occurs, the vehicle may plough straight ahead failing to negotiate the turn. This is particularly important on low-friction surfaces, such as when roads are covered in snow and ice.

### Low-Speed Offtracking

Low-speed offtracking represents a measure of the swept path of the vehicle and its lateral road space requirement when turning at intersections or when turning into loading areas.

This performance measure is evaluated for a standard 90-degree right-hand turn of radius 12.8 meters (measured at the center of the steering axle) negotiated at a speed of 5 km/h. This maneuver is illustrated in Figure C.12. The low-speed offtracking is determined as the maximum radial distance between the path of the midpoint of the steer axle and the path of the midpoint of the rearmost trailer axle.

**Figure C.12 Low-Speed Offtracking**

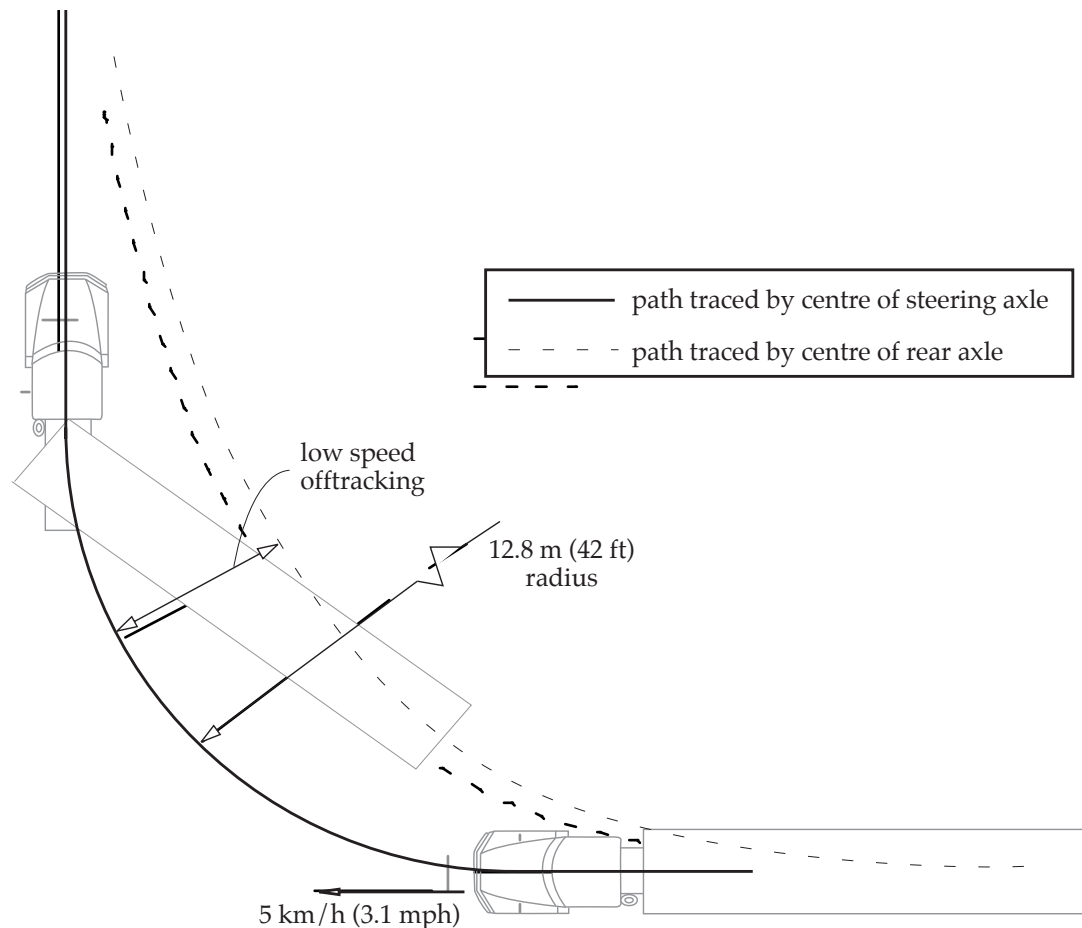

### High-Speed Offtracking

High-speed offtracking is defined as the extent to which the rearmost tires of the vehicle track outboard of the tires of the hauling unit in a steady-turn at highway speed. High-speed offtracking relates closely to road width requirements for the travel of combination vehicles. This maneuver is illustrated in Figure C.13.

This performance measure is evaluated for a constant-radius curve of radius 393 meters (1,290 feet), with a planar surface, negotiated at a speed of 100 km/h (62 mph); this maneuver produces a constant lateral acceleration of 0.2g. High-speed offtracking is determined as the radial distance between the path of the center of the steer axle and the path of the center of the rearmost trailer axle.

**Figure C.13 High-Speed Offtracking**

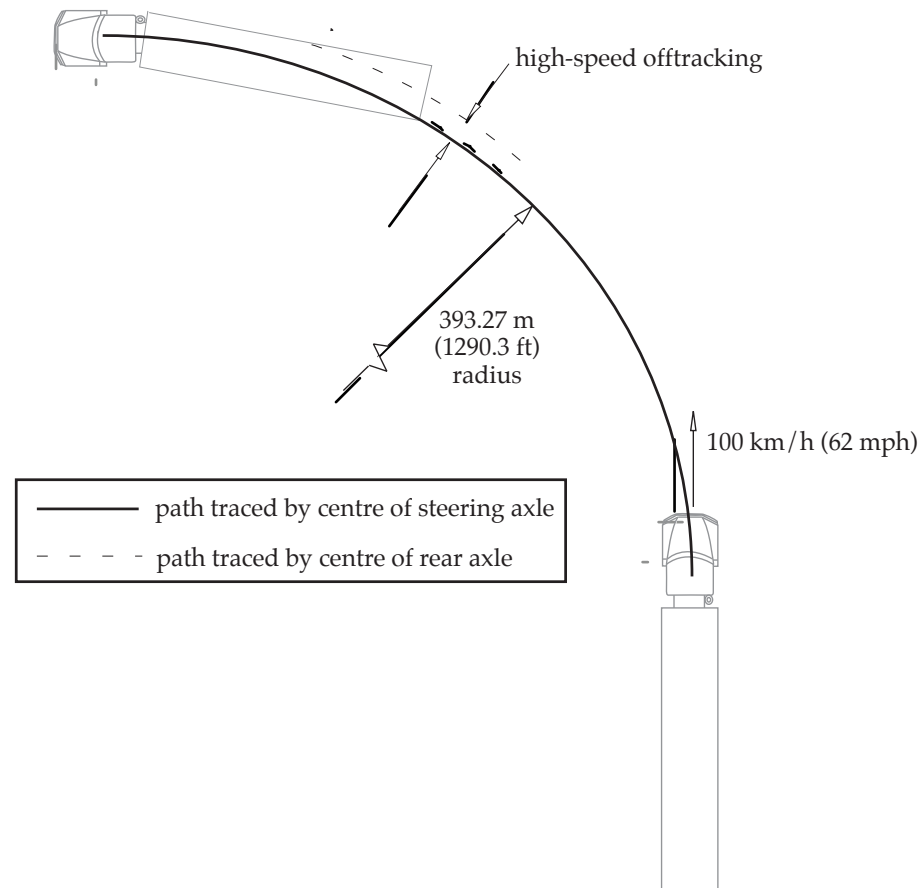

### *Transient High-Speed Offtracking*

Transient high-speed offtracking is a measure of the lateral excursion of the rear of the vehicle with reference to the path taken by the front of the vehicle during the same dynamic maneuver used for rearward amplification and transfer ratio. This expresses the amount of additional road space used by the vehicle combination in an avoidance maneuver.

### **Simulation Results**

The results of the simulations are found in Tables C.1, C.2, and C.3. Each table represents a different vehicle class. The column labeled target values contains a list of the recommended threshold values that demote acceptable vehicle performance. Some of the threshold target values have flexibility. However

target values for the primary vehicle dynamic measures “load transfer ratio” and rearward amplification should be respected.

**Table C.1 Performance Measures for the Six- and Seven-Axle Tractor Semitrailer**

Performance Measure	Target Value	Six-Axle Semi 90,000 (Fig. 3)	Six-Axle Semi 98,000 (Fig. 4)	Seven-Axle Semi 97,000 (Fig. 5)	Eight-Axle B-Train 108,000 (Fig. 6)
Static rollover threshold (ideal)	0.35g (min)	0.42g	0.40g	0.42g	0.42g
Load transfer ratio	0.60 (max)	0.34	0.309	0.33	0.32
Rearward amplification	2.00 (max)	0.98	0.977	0.96	1.34
High-speed transient offtracking	2.62 feet (max)	0.39 feet	0.36 feet	0.28 feet	0.92 feet
High-speed offtracking	1.51 feet (max)	0.85 feet	0.93 feet	0.79 feet	1.28 feet
Low-speed offtracking	19.69 feet (max)	17.25 feet	19.03 feet	18.99 feet	16.03 feet
High-speed friction utilization					
Tractor axles 2 and 3		25%	24%	26%	31%
Low-speed friction utilization					
Tractor axle 1		45%	45%	79%	42%

**Table C.2 Performance Measures for the Eight-Axle Double Configured as A- and B-Trains**

Performance Measure	Target Value	Seven-Axle Truck 1) 80,000 (Fig. 7)	Seven-Axle Truck 2) 80,000 (Fig. 8)	Six-Axle Truck and Pup 98,000 (Fig. 9)
Static rollover threshold (ideal)	0.35g (min)	0.43g	0.43g	0.33g
Load transfer ratio	0.60 (max)	0.34	0.34	0.73
Rearward amplification	2.00 (max)	1.0	1.0	1.69
High-speed transient offtracking	2.62 feet (max)	0.34 feet	0.37 feet	1.30 feet
High-speed offtracking	1.51 feet (max)	0.65 feet	1.19 feet	1.17 feet
Low-speed offtracking	19.69 feet (max)	11.98 feet	10.60 feet	8.90 feet
High-speed friction utilization				
Tractor axles 2 and 3		42%	42%	46%
Low-speed friction utilization				
Tractor axle 1		100%	100%	53%

## Graphical Results

Figures C.14-C.16 contain graphs designed to illustrate how the vehicles performance by performance measure category.



## Graphical Results

Figures C.14-C.16 contain graphs designed to illustrate how the vehicles performance by performance measure category.

### Figure C.14 Comparison of Static Rollover Threshold for All Vehicles

*Minimum Recommended Value 0.35g – Larger Values Are Better*

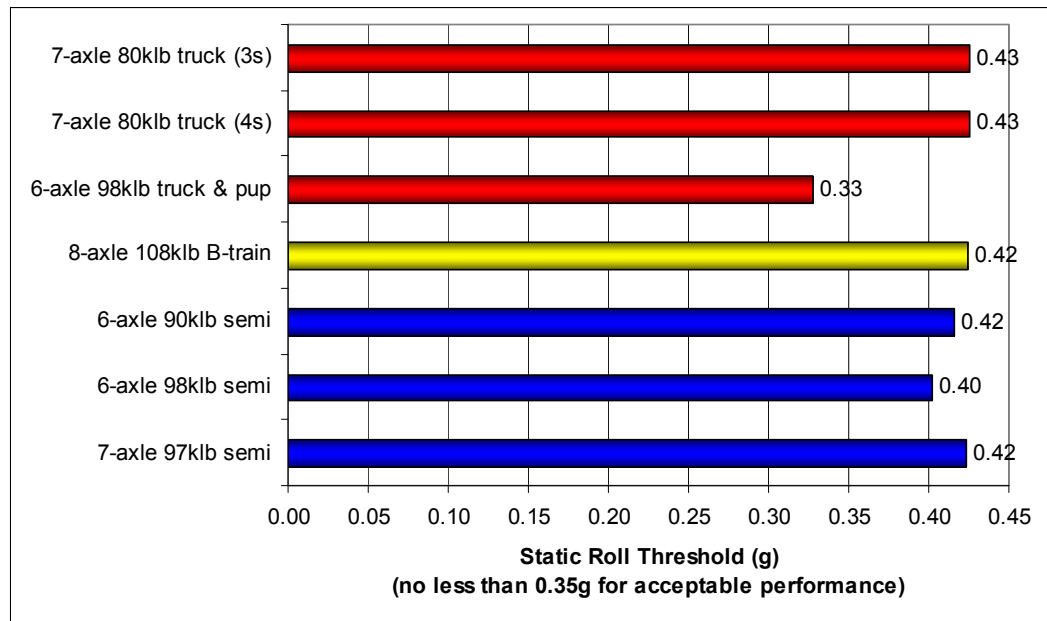

**Static Rollover Threshold** – All vehicles examined except for the six-axle 98,000-pound truck and pup unit had acceptable rollover threshold performance (Figure C.14).

**Figure C.15 Comparison of Load Transfer Ratio for All Vehicles**  
*Maximum Recommended Value 0.6 – Smaller Values Are Better*

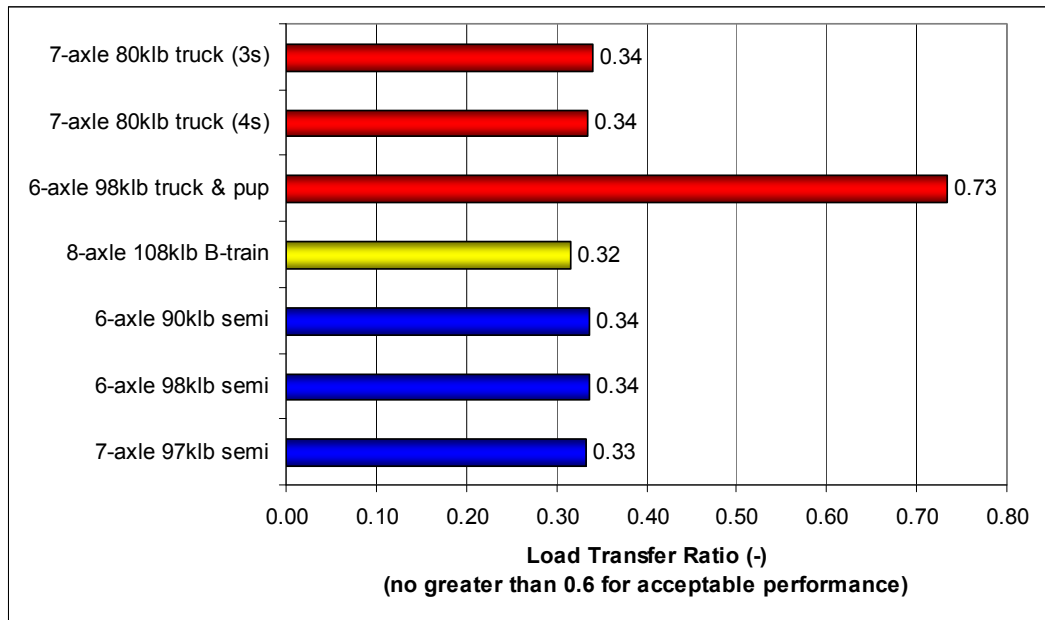

**Load Transfer Ratio** – Load transfer ratio is arguably the most powerful performance measure as it combines the influence of rearward amplification and static rollover threshold (Figure C.15). In the opinion of the author, the maximum target value of 0.6 should be respected. All of the configurations performed well except for six-axle 98,000-pound truck and pup unit which has unacceptably high load transfer ratio.

**Figure C.16 Comparison of Rearward Amplification for All Vehicles**  
*Maximum Recommended Value 2.0 – Smaller Values Are Better*

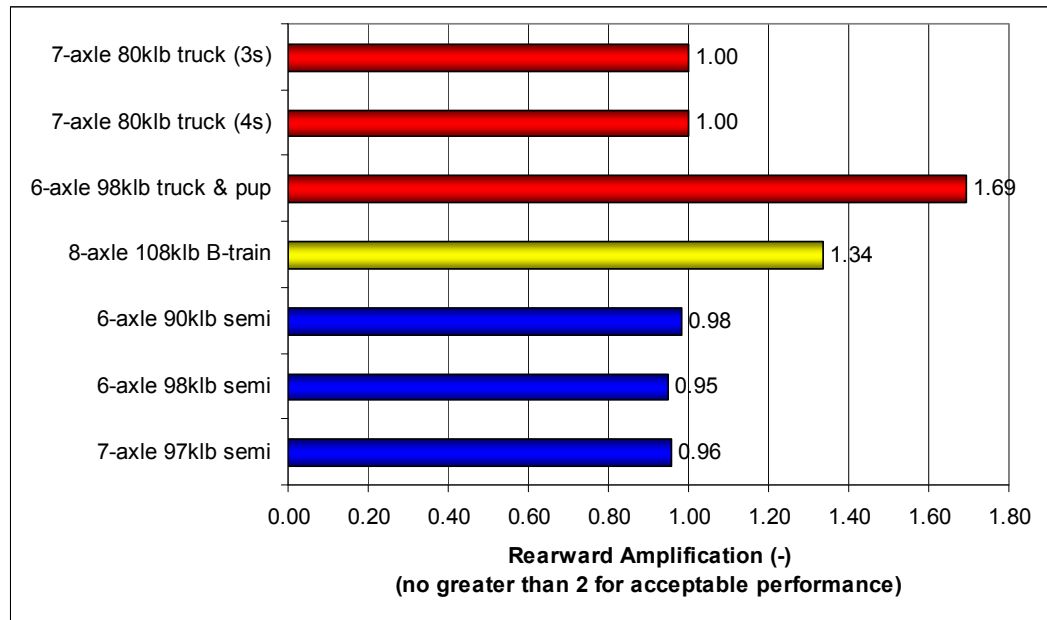

**Rearward Amplification** is a measure specifically developed to assess the dynamic quality of articulated vehicles. Generally the measure becomes more active as the number of articulation joints increase. The straight truck always has a ratio of unity as it is a single vehicle element. The six-axle 98,000-pound truck and pup unit is the most active unit, but it remained under the target value of 2.0.

**Figure C.17 Comparison of High-Speed Transient Offtracking for All Vehicles**  
*Maximum Recommended Value 2.62 Feet – Smaller Values Are Better*

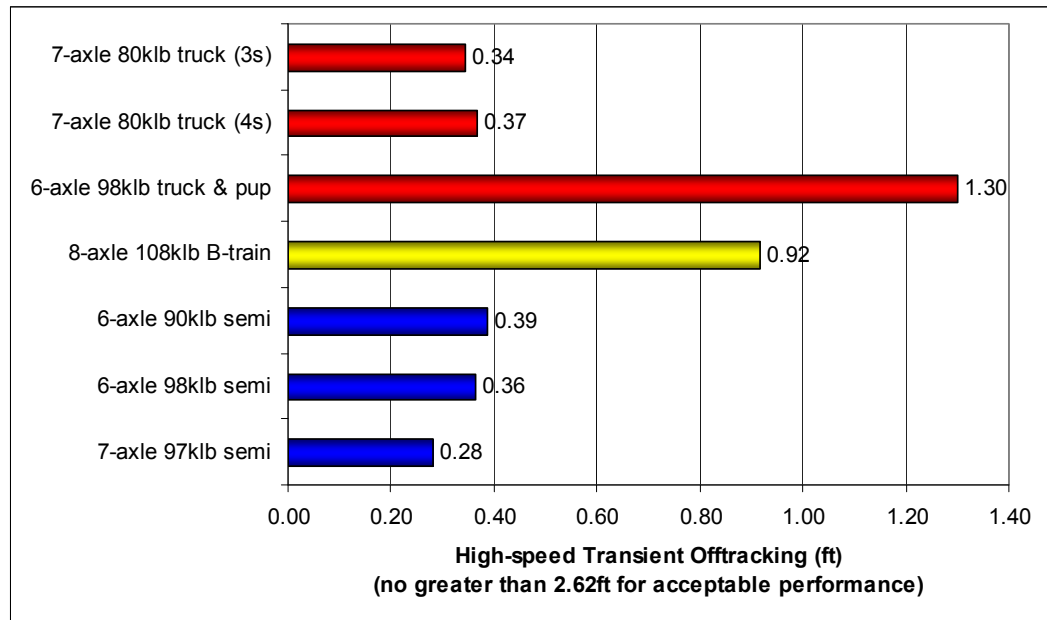

**High-Speed Transient Offtracking** increases with articulation, vehicle length, and mass. All of the vehicles were within the target value of 2.62 feet. The B-train and six-axle 98,000-pound truck and pup unit exhibited the largest amount of high-speed transient offtracking.

**Figure C.18 Comparison of High-Speed Offtracking for All Vehicles**  
Maximum Recommended Value 1.64 Feet – Smaller Values Are Better

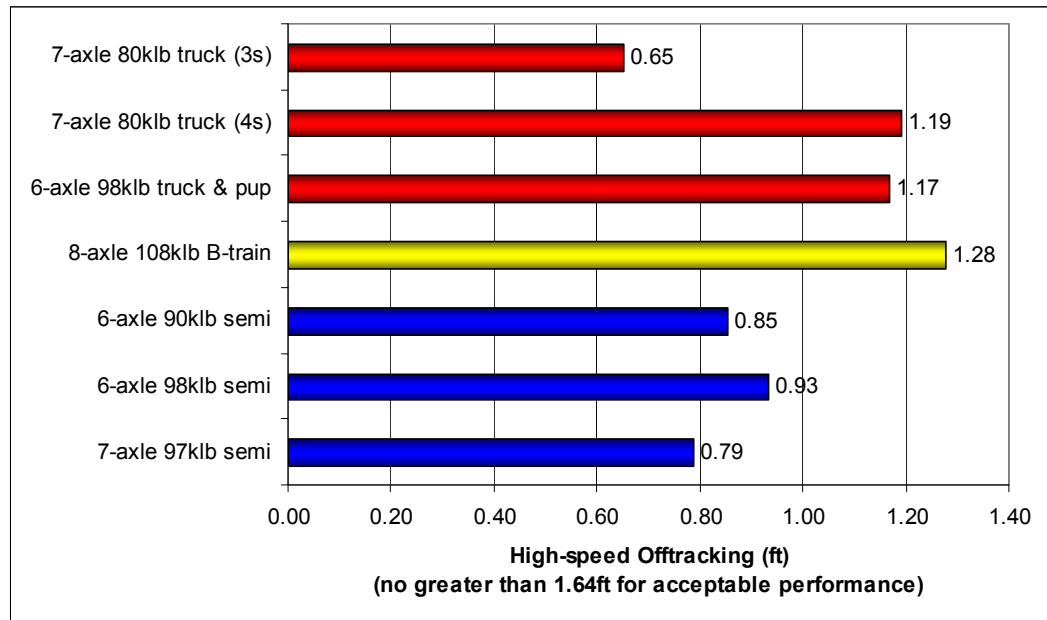

High-Speed Offtracking also increases with vehicle length and mass. It is less sensitive to the number of articulation joints than high-speed transient Offtracking. All of the vehicle options are within the acceptable limit.

**Figure C.19 Comparison of Low-Speed Offtracking for All Vehicles**  
Maximum Recommended Value 19.69 Feet – Smaller Values Are Better

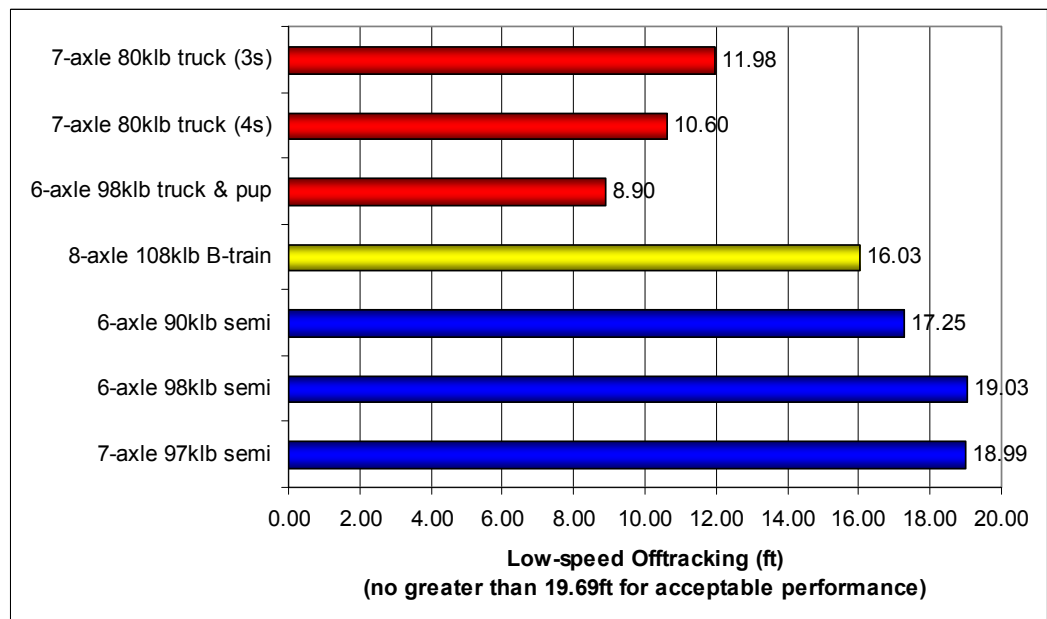

Low-Speed Offtracking is greatest for the tractor semitrailer combinations. All of the vehicles examined were within the limit of 19.69 feet. Low-Speed Offtracking can be an important indicator of a vehicle's ability to safely maneuver through roundabouts, with higher values indicating greater performance risks.

**Figure C.20 Comparison High-Speed Friction Utilization for All Vehicles**  
*Maximum Recommended Value NA – Smaller Values Are Better*

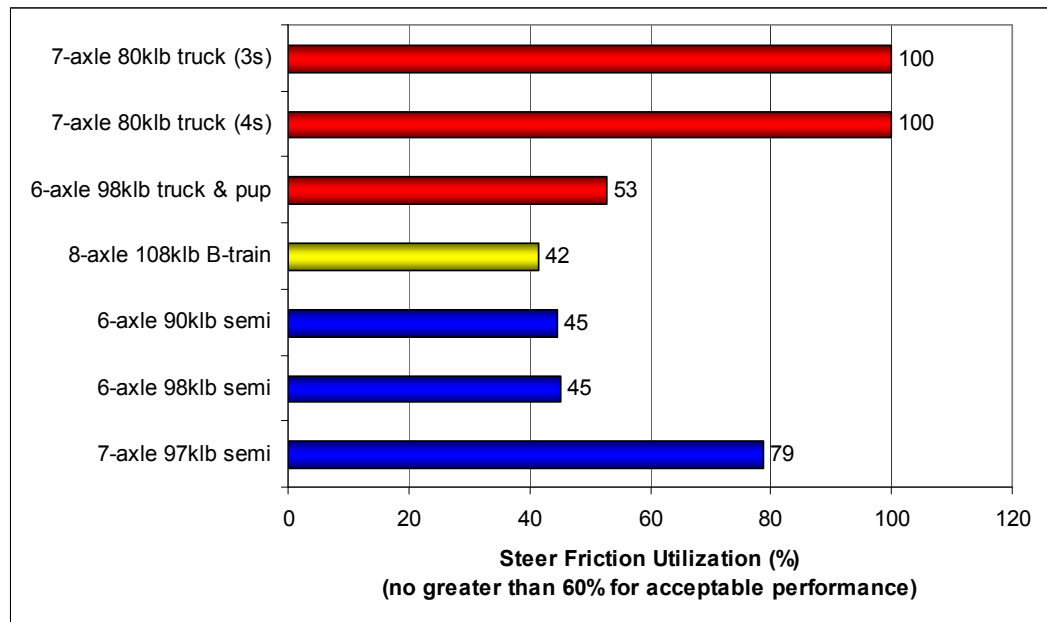

**Low-Speed Friction Utilization** of the steer axle gives an indication of the steerability of a vehicle. A high level of friction utilization means that much of the available friction between the road and tire is being consumed steering the vehicle. Under these conditions if brakes were applied the tires may saturate and be unable to direct the vehicle as the driver demands. When the low-speed friction demand reaches 100 percent, the low-speed vehicle directional control becomes highly compromised and practically ineffective. The straight truck with multiple axles was found to have very high levels of friction utilization making this vehicle impractical. The seven-axle tractor semitrailer also exceeds the limit.

## Discussion

The seven-axle 97,000 pound tractor semitrailer (Figure C.5) satisfies all of the dynamic performance criteria, it nevertheless does have excessive low-speed steer axle tire friction utilization due to the aligning moment created by the tri-drive axle group. This can compromise low-speed maneuverability of the tractor particularly on low-friction surfaces. Excessive low-speed tire friction on the tractor tri-drive axle group was experienced by the outermost tires. The high drive axle friction utilization values will result in transverse tire scrubbing forces which highlight potential maintenance issues in terms of tire, suspension and chassis wear.

The seven-axle 80,000 pound straight truck configurations satisfy all of the performance criteria except for the low-speed steer axle tire friction utilization. Initially, the self-steering axles were modeled with a maximum steer angle of 15 degrees but the trucks ploughed straight ahead and could not negotiate either of the prescribed low-speed turns. These prescribed turns were 42-foot 90-degree turns at the speeds of 3.11 and 11.18 miles per hour. The reason for this result was that their self-steering axles, the lead ones in particular, hit their bump-stops mid-way through the turn thus increasing the friction demand on the front steer tires to the point of saturation making the vehicle uncontrollable. The maximum steer angles of the self-steering axles were then increased to 35 degrees so that they would not hit their bump-stops during the turns. Although increasing the self-steering angle enabled the trucks to complete the low-speed turns, when undergoing the 11.18-miles-per-hour turn, they undertook wider turn radii than that prescribed because the friction demand of the front steer tires again reached saturation – the truck with three self-steering axles performing particularly poorly. The main reason for this result was that the cornering forces of the front steer tires have to counteract the centering forces imposed by the tires of the self-steering axles. When undergoing the 11.18-mile-per-hour turn, the trucks demanded more steer tire friction force than was available on the modeled surface with a peak tire/road friction coefficient of 0.8 which is typical for dry asphaltic or concrete roads. This implies that these trucks will have difficulty negotiating low-speed turns on typical road surfaces. The straight truck with four self-steering axles occupied less road width on the prescribed low-speed turn than the three self-steering axle variant because of its shorter effective wheelbase.

The straight truck with three self-steering axles occupied less road width on the prescribed high-speed turn and path change or evasive maneuver than its four self-steering axle variant because of its longer effective wheelbase and because it has fewer self-steering axles which results in higher net vehicle cornering stiffness. The centering forces on the self-steering axles stabilize the trucks at high-speed and they also limit the amount of high-speed offtracking. Most self-steering axles permit maximum steer angles of between 10 and 20 degrees. Some permit maximum steer angles approaching 30 degrees, but at such high self-steering angles, it is likely that these axles can only be configured with single tires so that they do not excessively limit their suspension track widths. Because

of these performance problems the straight truck options examined in this analysis are not considered to be viable.

The six-axle 98,000 pound straight truck and pup trailer failed to satisfy the load transfer ratio and static rollover threshold performance measures. For truck and pup trailer configurations, the worst performing vehicle unit with the lowest rollover stability on high-speed turns (lowest SRT) and path changes or evasive maneuvers (highest LTR) is usually the pup trailer – and this configuration is no different. A major factor for this result is the tow-eye (or pintle-hook) coupling used to connect the straight truck and pup trailer together. Tow-eye couplings do not provide roll-coupling between the vehicle units and so not every axle can contribute to the rollover stability of the combination. Compare this with conventional fifth-wheel couplings such as those used on tractor semitrailers and B-trains that do provide roll-coupling between their vehicle units and so every axle contributes to the rollover stability of the combination. The coupling offset is the distance between the rear-axis (centre of the nonsteering axle(s) of the rearmost axle group) of the towing vehicle and the coupling. Typically this is much larger for tow-eye couplings than for fifth-wheel couplings which can even have a zero offset. Although larger coupling offsets improve low-speed maneuverability, they also degrade high-speed stability by exacerbating the phenomenon known as rearward amplification. For these reasons pup trailers tend to exhibit poor dynamic performance unless specific vehicle design countermeasures are put in place.



# D. Study Advisory Group Commentary

## D.1 OVERVIEW

The Wisconsin Assembly Bill 238, passed as part of Wisconsin Act 20 in October of 2007, directed the Wisconsin Department of Transportation (WisDOT) to undertake the Wisconsin Truck Size and Weight Study. The statute also called for the creation of a Study Advisory Committee including representation from the Department of Commerce, local governmental units, trucking companies, industries and small businesses that depend on truck transport, enforcement agencies, and other groups and individuals that are interested and knowledgeable about truck size and weight limits.

In accordance with the statutory directive, the following individuals accepted WisDOT's invitation to serve as members of the Study Advisory Committee:

- Wisconsin Department of Transportation (Rory Rhinesmith, Statewide Bureau Operations Director, and David Vieth, Bureau of Highway Operations Director, sponsors and co-chairs of the Advisory Group)
- Department of Commerce (Tom Coogan, Environmental Resources Specialist)
- Wisconsin Motor Carriers Association (Tom Howells, President)
- Wisconsin Counties Association (Mark O'Connell, Executive Director)
- Wisconsin County Highway Association (Dan Fedderly, Executive Director and Emmer Shields, Ashland County Highway Commissioner)
- The Great Lakes Timber Professionals Association (Henry Schienebeck, Executive Director)
- Wisconsin Alliance of Cities (Paula Vandehey, City of Appleton Public Works Director)
- Wisconsin Agri-Service Association (John Petty, Executive Director)
- Wisconsin Towns Association (Rick Stadelman, Executive Director)
- AAA Wisconsin (Tom Frymark, President)
- University of Wisconsin-Superior (Dr. Richard Stewart, Director of Transportation and Logistics Research Center)
- State Representative Mark Gottlieb
- State Senator David Hanson

The committee met five times and provided WisDOT with guidance for implementing the Truck Size and Weight Study including review and comment

on draft technical papers and the draft final report. A few members of the committee exercised their statutory right to “present written commentary on or dissenting views from the report.” These comments are published as received in the following section.

## D.2 COMMENTARY FROM AAA WISCONSIN

On behalf of our 615,000 AAA-Wisconsin members, we appreciate the opportunity to provide these supplemental comments.

The Truck Size and Weight Study that the Wisconsin DOT performed was both thorough and comprehensive. Our service on the Study Committee confirmed that the subject involves some complexities. In addition, it was reassuring to interact with highly-qualified and concerned Wisconsin DOT truck policy and the enforcement staff.

It is significant that the Wisconsin Department of Transportation does not recommend that larger and heavier trucks be allowed on Wisconsin roadways. State bridges in Wisconsin total more than 14,000 and many are already deficient and require approximately **\$550 million** in spending to no longer be deficient. Until such existing needs are first met, we cannot decide whether bigger and heavier trucks should be allowed on Wisconsin and local bridges and roadways.

The Wisconsin DOT study references, among other materials, the private sector outreach findings that the Wisconsin DOT gained. Schneider National Trucking Company’s remarks are particularly notable:

- “Public perception is that trucks are dangerous (13 people killed everyday from truck crashes), and it will be difficult to convince the public that an increase in productivity is only viable by increasing size and weight.”
- “Rather instead of increasing size and weight, the interviewee [from Schneider National] suggested there be a system put in place to help decrease empty trailer hauls.”

Those businesses that would benefit from bigger and heavier trucks are not necessarily the same people who would bear the burden of higher infrastructure costs or the higher number of fatalities caused by larger trucks. Wisconsin taxpayers and motorists, including AAA Wisconsin members, are already highly stressed by the financial burdens imposed on them.

Wisconsin today also has a problem with inadequate state and local enforcement resources for truck sizes and weights. In addition, the fines Wisconsin imposes are low, compared to many other states. As the Study Committee learned, this has created an **incentive for noncompliance**. Certainly, this untenable situation needs to be remedied as quickly as possible.

Finally, we doubt that most people are aware that **pavement damage from trucks increases at a geometric rate with truck weight increases**. Large trucks also historically have a higher **fatal** crash rate than other vehicles. As cars get

smaller in order to achieve greater fuel efficiency, allowing bigger trucks on our roadways may exacerbate fatality rates.

For these reasons and others, AAA Wisconsin joins the Wisconsin DOT and rejects Wisconsin increasing its truck size and weight standards at this time.

Very truly yours,

AAA WISCONSIN

Tom Frymark

President

The Auto Club Group

8401 Excelsior Drive

Madison, WI 53717

608-828-2573

608-828-2457

E-mail: [tfrymark@aaawisconsin.com](mailto:tfrymark@aaawisconsin.com)

### **D.3 COMMENTARY FROM STATE REPRESENTATIVE MARK GOTTLIEB**

This study has shown that at least four of the new configurations have net benefits in all the categories (transport, pavements, safety, and congestion), provided they are not operated on deficient or inadequate structures. The draft report concludes that because there are many structures that are inadequate for the new configurations, the new configurations should not be allowed until all deficient structures in the state have been replaced.

This is an unnecessarily conservative conclusion. By recommending an “all routes or none” approach, the draft report ignores the economic, safety, and infrastructure benefits that can be gained by allowing the new configurations on routes with suitable structures. This could be accomplished by allowing the new configurations by permit on routes which have been predetermined not to have structures that are inadequate.

Therefore, I suggest that the following policy recommendation should be added to the report.

**Consider legislative changes that would allow the Department to issue single or multiple trip permits (including divisible loads) for the new configurations, provided that all structures on the proposed route are adequate, and that the permit holder pays all costs related to the issuance and use of the permit.**

This recommendation does not violate any of the nine agreed upon guiding principles of the study.

Representative Mark Gottlieb

## **D.4 COMMENTARY FROM THE GREAT LAKES TIMBER PROFESSIONALS ASSOCIATION**

The Great Lakes Timber Professionals Association (GLTPA) would like to add the following comments to Wisconsin TSW study final report.

First of all we would like to congratulate the Wisconsin Dept of Transportation and Cambridge Systems for completing this monumental task by the end of 2008. It is our hope that the study will provide a progressive thought process, which will make Wisconsin's transportation system more efficient as we move into the future.

As is, the study does a good job in providing guidance to help WisDOT become more efficient in areas of permitting oversize/overweight loads, and it also suggests the need for a central freight office. What the study does not offer is suggestions on how we can modify and better utilize current bridges and truck configurations to meet the needs of Wisconsin's transportation providers/users. At all the meetings our Association attended it was clear that we need to make an investment in Wisconsin's infrastructure to accommodate heavier loads, and that the money paid into the transportation fund needs to stay in that fund and support transportation. At this point in time the GLTPA would suggest that more funds are needed at the town and county level than the state level.

Over time manufacturing plants have been combined into larger processing facilities and traveling distances have become greater for raw material such as those generated by agriculture and forestry. The fact that these are the two largest industries in Wisconsin, and the raw material they provide create thousands of secondary tax paying jobs, gives compelling reason that more money needs to be invested at the local level to insure an un-interrupted, efficient and cost effective flow of that raw material. Because of the location of cheese factories and pulp mills specific routes can be easily identified for heavy truck traffic on state roads, however because of the vast amount of land covered by forests and farms it would be almost impossible to designate specific routes of travel to access main highways.

If Wisconsin were to adopt new configurations for heavier trucks, it is unclear what the gain would be at the interstate level. With the exception of Michigan, there are very few states, which would allow those configurations on a regular basis making them useful only for intrastate travel. Again it would be beneficial to invest more money at the local level for maximum efficiency in transporting goods throughout Wisconsin.

With the recent down turn in the economy world wide, it is our opinion that this study should be used as a tool by the Department of Transportation to begin and strengthen economic recovery in Wisconsin. Showing support for the tax payers of Wisconsin by moving this effort forward will certainly go along way to ensure jobs for everyone.

Respectfully Submitted,  
Henry Schienebeck  
Great Lakes Timber Professionals Association  
Rhineland, Wisconsin

## **D.5 COMMENTARY FROM THE WISCONSIN COUNTY HIGHWAY ASSOCIATION, WISCONSIN COUNTIES ASSOCIATION, WISCONSIN TOWNS ASSOCIATION, AND WISCONSIN LEAGUE OF MUNICIPALITIES**

Our Associations are in agreement with the Wisconsin Department of Transportation's (WISDOT) recommendation that no change be made to Wisconsin's Truck Size and Weight (TSW) Laws at this time. While WISDOT cited concerns over current economic conditions, declining state revenue and potential infrastructure costs associated with possible changes in TSW, our Associations have additional concerns that if the limitations of the study are not recognized, poor public policy decisions could be made.

The study addresses broad TSW questions in a global way and develops a number of suppositions. The study is not a framework for legislation, but a starting point for investigation, consultation, and development of in-depth public policy initiatives.

Specific concerns that can be raised by the study's suppositions include: the assumption that all loadings are legal, when there is considerable empirical evidence that there is significant noncompliance with current TSW laws; global calculation of benefits versus cost, when local or area impacts could be significantly different; A Clear lack of local area existing conditions consideration and consideration of existing conditions that provide less structure than design conditions; and the clearly identified increased costs for local bridge infrastructure offset by private sector economic benefit, without a plan or mechanism to support the increased infrastructure cost. In Addition we feel the Study does not address the significant issue of Bridges under 20 feet, which in pure numbers pales the number of Bridges in the WISDOT inventory, and with the impact cost to upgrade again paling the cost of the bridges as the study shows.

The Study lists five strategies for pursuing the issue of TSW Law modification, which our Associations can support as essential elements to any development of new law. In particular the issue of enforcement must be the first issue addressed, since present TSW laws are not being sufficiently enforced to protect Wisconsin's infrastructure, especially on the 100,000 mile local road system. Two approaches could be put forth for successfully enforcing TSW law; heavy sanctions and light enforcement or heavy enforcement and light sanctions. Wisconsin's present paradigm is light enforcement and light sanctions, which leads to one outcome,

economic benefit for those who violate the law and disrespect for the rule of that law. Wisconsin has centered its enforcement strategy on the interstate system and high volume state highways, which has pushed much of the overload problem onto the local system, where there is little or no enforcement presence. Wisconsin's overweight fine structure was last changed in 1971 and would have to be increased approximately 5 times its current level to have the same deterrent effect it had at that time. Wisconsin does not have a system available for civil forfeiture for overloads identified through delivery site bills of lading, as other states do. Clearly, the time has come for the State of Wisconsin to protect its infrastructure investment and no TSW law changes should be considered until there are assurances that those changes would be part of an overall strategy that includes reasonable expectations for TSW law compliance.

The Study fails to list one strategy that must be included in any development of TSW law, that strategy is local government involvement. Approximately 90 percent of all road mileage in the State of Wisconsin is under local jurisdiction and control. Any effort to change TSW law must include local governments as part of the development process. Failure to do so will lead to continued breakdowns in TSW enforcement and the very continuity of the transportation system we are trying to improve. Our Associations would recommend that State government avail itself of resources such as the Local Roads and Streets Council for participation in any TSW law revision effort. Our Associations also stand ready directly to participate in such an effort.

Daniel J. Fedderly P.E.; R.L.S.  
Executive Director, WCHA

Rick Stadelman  
Executive Director, WTA

Emmer Shields P.E.  
Ashland County Highway  
Commissioner

Paula Vandehey  
Public Works Director  
City of Appleton



## Wisconsin **TRUCK SIZE AND WEIGHT STUDY**

# Final Report

JUNE 15, 2009